

44W Constant Current DALI-FLS Series

FLS-40-1050 DALI2 LA1

Code Aric :52043 - 52040 - 52039

■ Approve

SELV

■ Features

- Class II, SELV, independent
- Input Voltage 220-240VAC
- Protections: SCP/OLP/OVP/OTP
- Power Factor >0.95
- Efficiency ≥87%
- Support DALI II, Push Dimming
- 5 years warranty

■ Applications(Typ.)

- LED strips
- LED panel
- Spot light
- Down light

■ Description

FLS-40-1050 DALI2 LA1 is a 44W constant current LED driver with 700 to 1050mA output current and a forward voltage range from 9 to 52Vdc. The output current is selectable by DIP Switch. With it's dimensions from 187 x 45 x 30.5mm it is easy to integrate in LED Panel, spot and down light products. To ensure trouble-free operation, protection is provided against output short circuit and over Load.

■ Model code

FLS-40-1050 DALI2 LA1

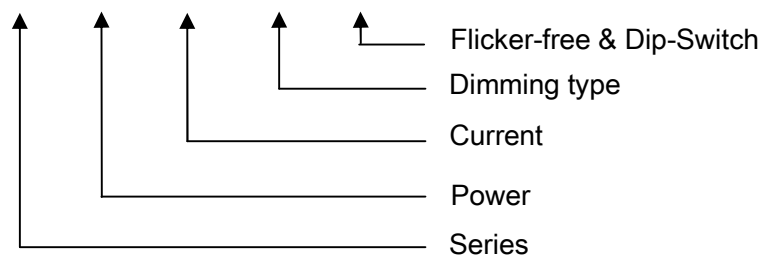

44W Constant Current DALI-FLS Series

FLS-40-1050 DALI2 LA1

■ Specification

Input	Rated input voltage	220-240VAC
	Range of input voltage	176-264VAC
	DC voltage range	198-254V
	Frequency(Hz)	0/50/60 Hz
	Power Factor	> 0.95@220-240VAC, full load
	Input Current max	0.34A MAX. @Full Load,176VAC
	Start-up time	< 1S
	Unload Power Consumption	≤0.5W
	Inrush Current	30A Max./80μs@230V, Full Load , 50%Ipk-50%Ipk
	THD	10% Typ. @Full Load,240VAC, I _o =1050mA
	Leakage Current	< 0.7mA(240VAC)
Output	Constant Current	700/.../1050mA
	Unload voltage Max.	60 VDC
	Voltage Range(VDC)	9-52VDC
	Rated power	44.1W Max.
	Current Accuracy	±5% @220-240VAC
	Voltage Regulation	±5% @220-240VAC, full load
	Load Regulation	±5% @220-240VAC
	Hold-up Time	1s max.@Full Load
	Output HF current ripple *Note.2	≤±10% @Full Load,240VAC
	Output LF current ripple(<120Hz)	≤±3% @Full Load,240VAC
	Efficiency(Typ.)	≥87%
Dimming	Dimmable	YES
	Dimming mode	DALI II, Push
	Dimming current range	1%~100%
Protection	Over Load Protection	103-120% Protection type: Latch off
	Over Voltage Protection	> 60VDC Protection type: Latch off
	Short circuit Protection	Protection type: Latch off
	Over Temperature protection	Protection type: Auto Resume
Environment	Operating Temperature	-20°C...+45°C
	tc	75°C
	Storage Temperature	-25°C...+60°C
	Life time	> 44,000h@45°C
	Humidity	20%-90%RH
Others	Dimension(LXWXH)	187X45X30.5mm
Safety & EMC	Safety standards	EN 61347-1; EN61347-2-13; EN62384
	Withstand voltage	Input-Output : 3750V/5mA/1min
	Isolation resistance	Input-Output : ≥4MΩ@500VDC
	EMI	EN55015; EN61000-3-2 Class C; EN61000-3-3
	EMS	EN 61547; EN 61000-4-2; EN 61000-4-5 —1000V;
Note	1.All parameters NOT specially mentioned are measured at 240VAC input , full load and 25°C of ambient temperature. 2.Ripple & Noise are measured at 20MHz of bandwidth by using a 300mm twisted pair-wire terminated with a 0.1uF & 47 uF parallel capacitor.	

44W Constant Current DALI-FLS Series

FLS-40-1050 DALI2 LA1

Adjustable Output Current with dip-switch

Vo	Po	Io	3	2	1
9-52VDC	36.4W	700mA	--	--	--
9-52VDC	39W	750mA	--	--	ON
9-52VDC	41.6W	800mA	--	ON	--
9-49VDC	41.7W	850mA	--	ON	ON
9-49VDC	44.1W	900mA	ON	--	--
9-46VDC	43.7W	950mA	ON	--	ON
9-44VDC	44W	1000mA	ON	ON	--
9-42VDC	44.1W	1050mA	ON	ON	ON

Wiring diagram

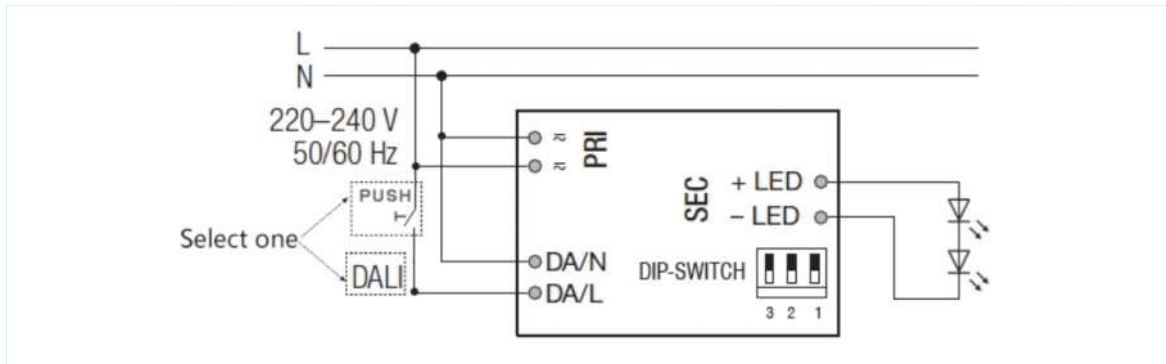

2D diagram

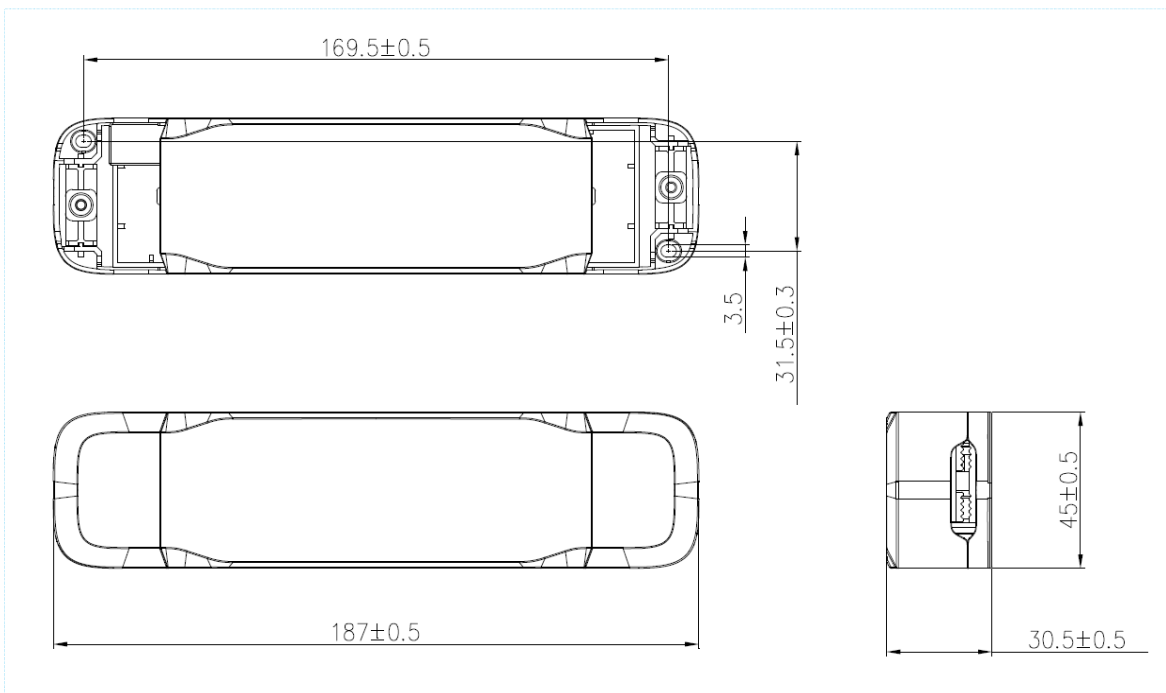

44W Constant Current DALI-FLS Series

FLS-40-1050 DALI2 LA1

■ Curve for FLS-40-1050 DALI2 LA1 , $I_o=1050\text{mA}$

Lifetime vs. Ambient Temperature Curve

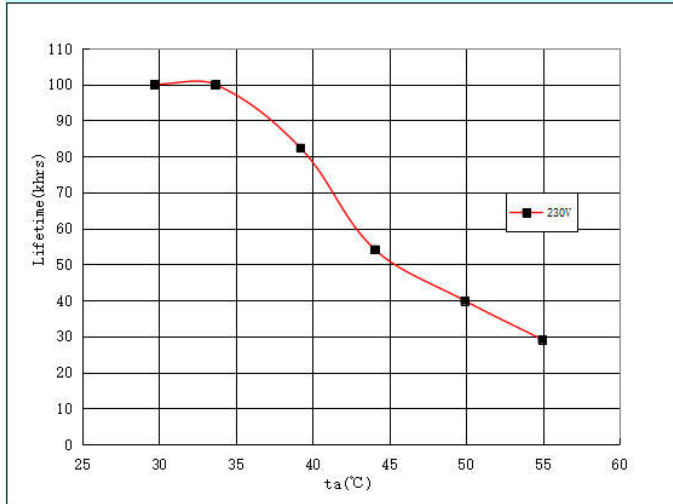

Efficiency vs. Load

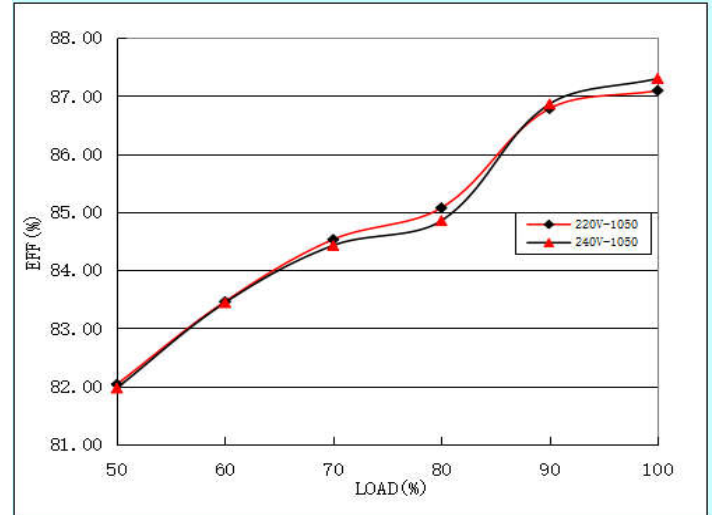

Power Factor Characteristics

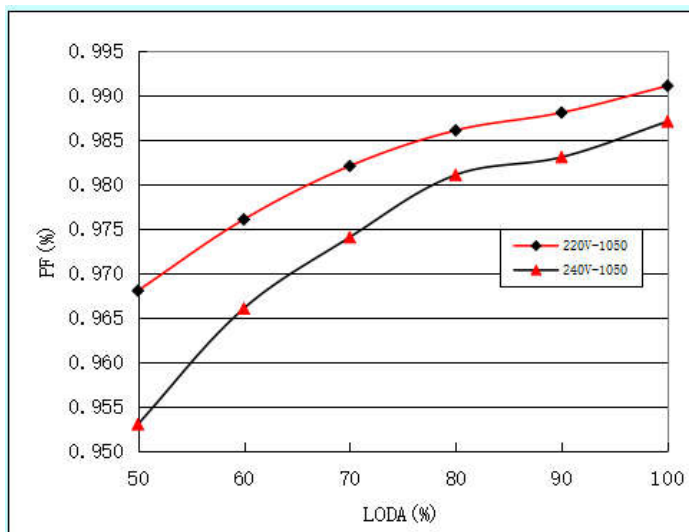

THD vs. Load

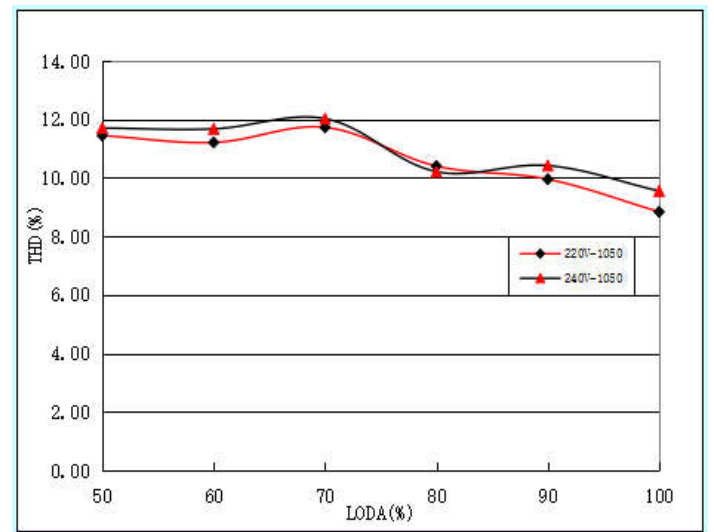

44W Constant Current DALI-FLS Series

FLS-40-1050 DALI2 LA1

■ Operating window

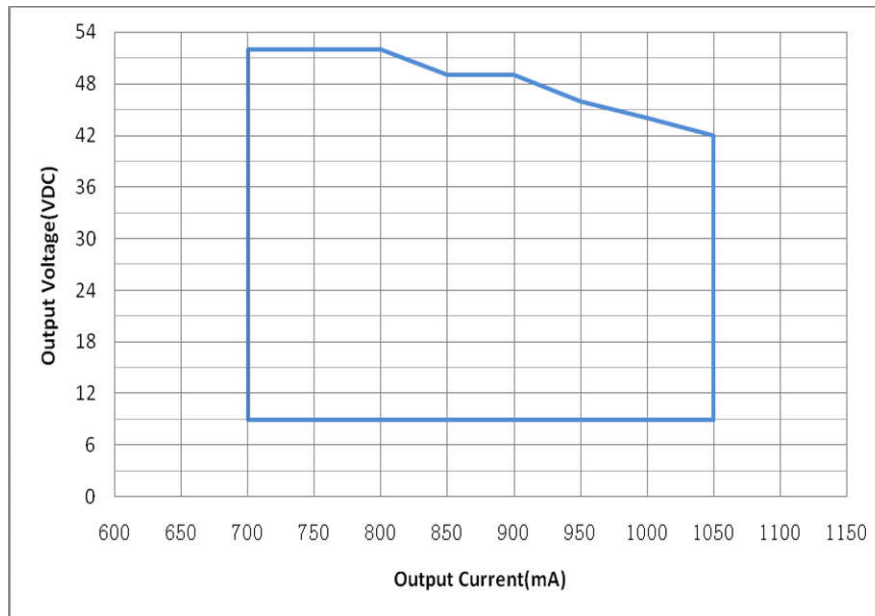

— Operating window 100%