

Category 6A  
(CJSLRCAPBU-X)

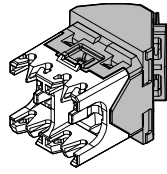

Category 6  
(CJSLRCAPIW-X)

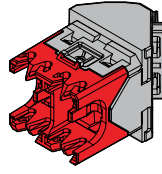

Category 5e  
(CJSLRCAPRD-X)

Jack

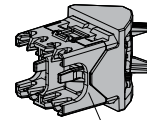
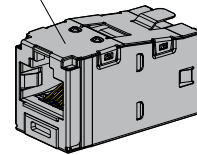

45° Left/Right  
Wire Cap

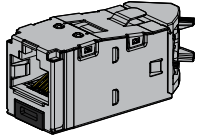

45° ANGLED JACK  
CJSLR688TG\*\*Y,  
CJSLR6X88TG\*\*Y

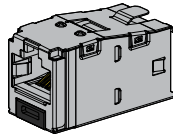

STANDARD  
CJS%%88TG\*\*Y

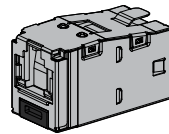

SPRING SHUTTERED  
CJSH%%88TG\*\*Y

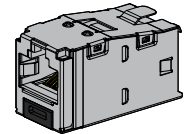

KEYED  
CJSK6X88TG\*\*Y

### Compatible Jack Modules

### Understanding the Label

**IMPORTANT!** Determine the desired direction of cable **before** wiring the cap. The cap, in relation to the jack, **must** be kept consistent throughout the entire termination.

#### Left Orientation

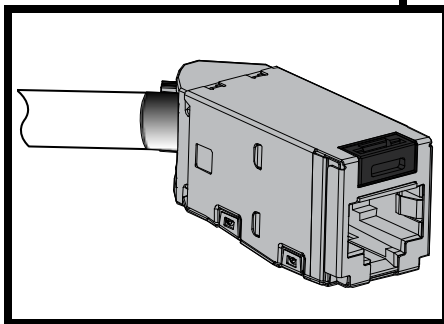





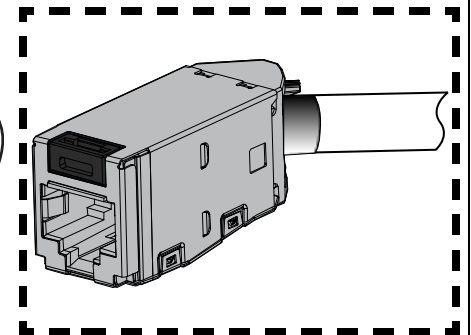



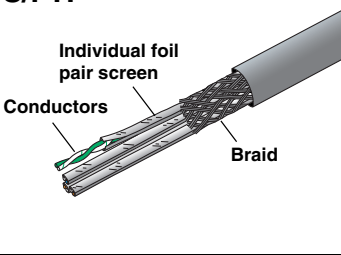
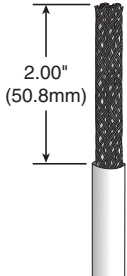

Follow solid line  
instructions for  
**Left Orientation.**  
(Pages 3-4)

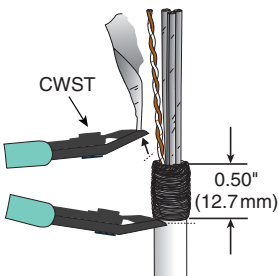
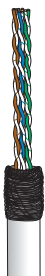
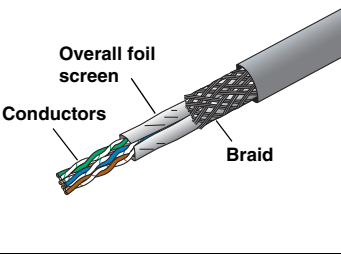
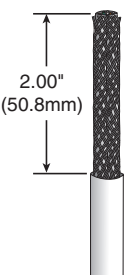
#### Right Orientation

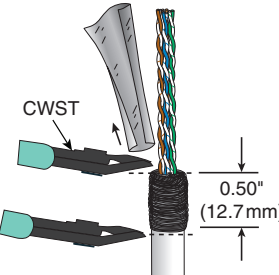

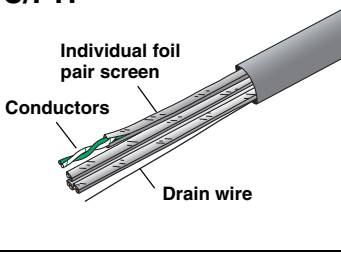
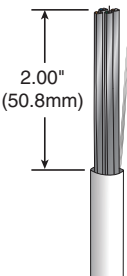
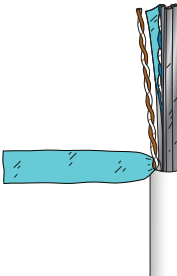
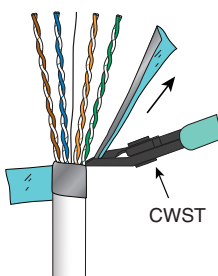
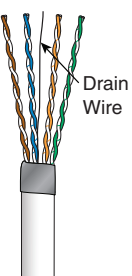
Follow dotted line  
instructions for  
**Right Orientation.**  
(Pages 5-6)

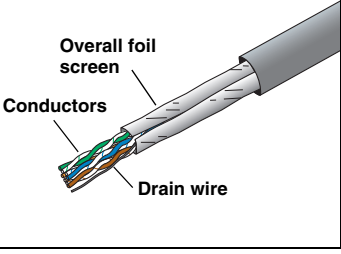
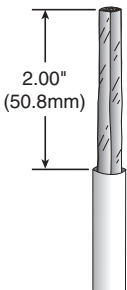
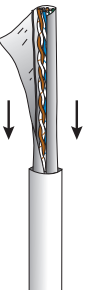
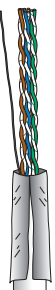
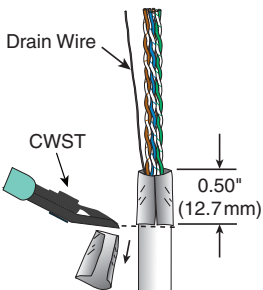
**CABLE PREPARATION STEPS**

<p><b>S/FTP</b></p>  <p>Individual foil pair screen Conductors Braid</p>	 <p>2.00" (50.8mm)</p>			 <p>CWST</p> <p>0.50" (12.7mm)</p>	
<p><b>SF/UTP</b></p>  <p>Overall foil screen Conductors Braid</p>	 <p>2.00" (50.8mm)</p>			 <p>CWST</p> <p>0.50" (12.7mm)</p>	
<p><b>U/FTP</b></p>  <p>Individual foil pair screen Conductors Drain wire</p>	 <p>2.00" (50.8mm)</p>		 <p>CWST</p>	 <p>Drain Wire</p>	
<p><b>F/UTP</b></p>  <p>Overall foil screen Conductors Drain wire</p>	 <p>2.00" (50.8mm)</p>			 <p>Drain Wire</p> <p>CWST</p> <p>0.50" (12.7mm)</p>	

### Left Orientation

1

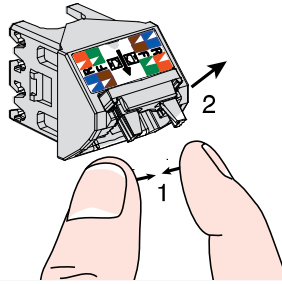
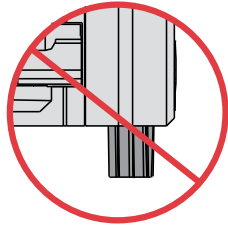
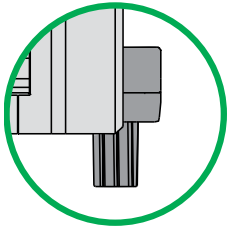

**IMPORTANT!**  
Be sure that strain relief is fully retracted before inserting cable.

2

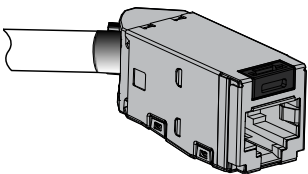
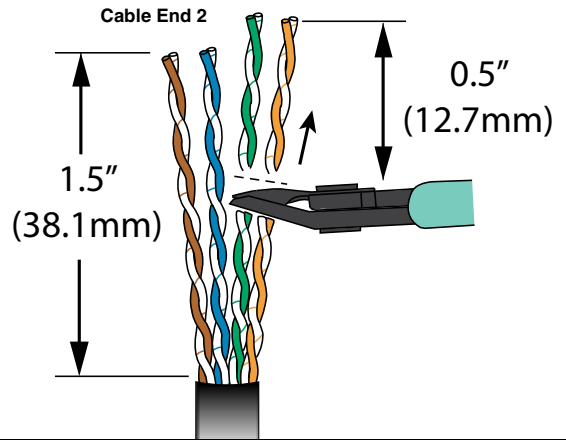
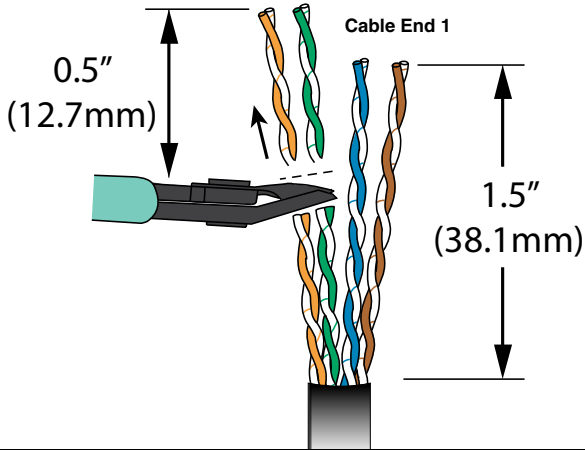

Do not pre-arrange conductors.

3

Bend wires to ease inserting them into the cap.

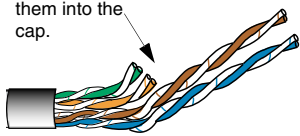

4

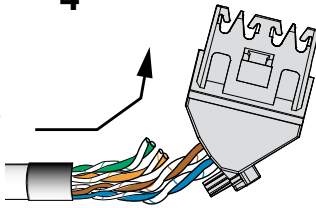

5

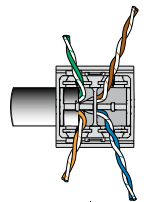
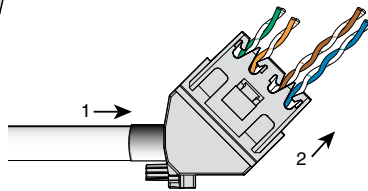

(OR)

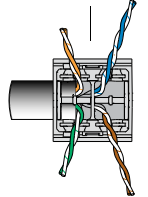

Cable End 1 Shown

6

Be sure cable is fully inserted into wire cap

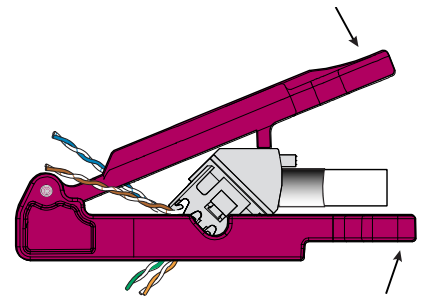
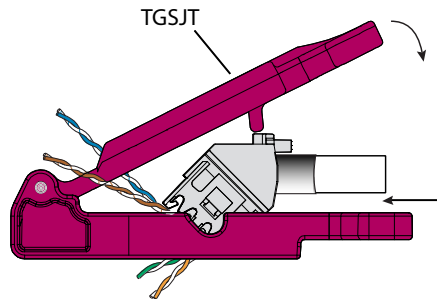
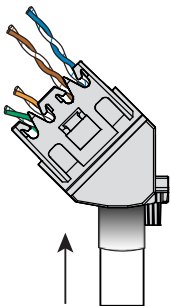

Cable End 1 Shown

### Left Orientation

7

#### T568B Wiring

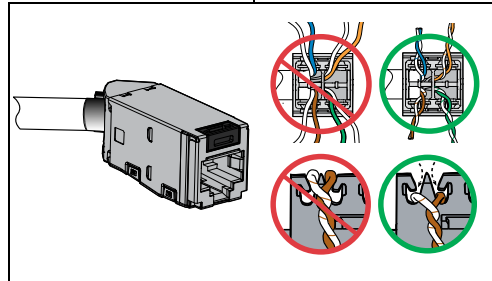
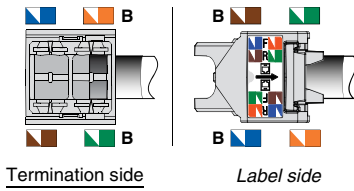

#### T568A Wiring

T568A not shown on wire map label

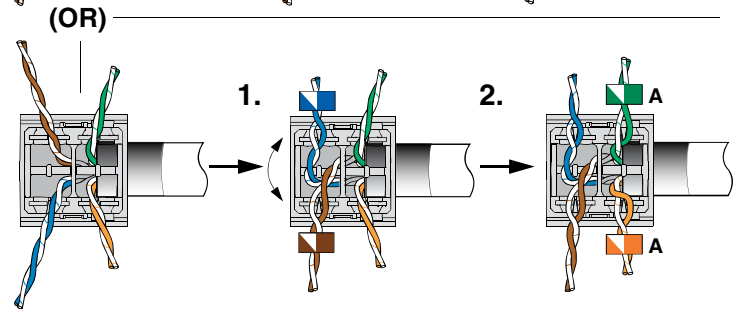
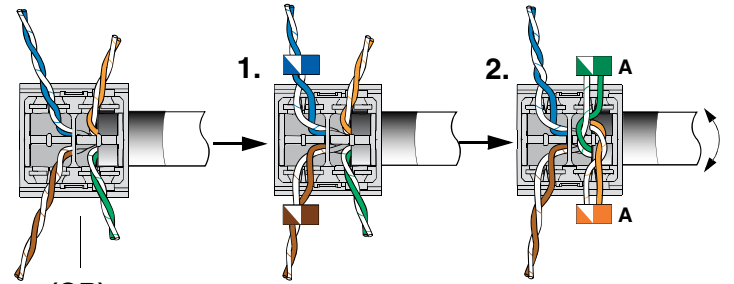
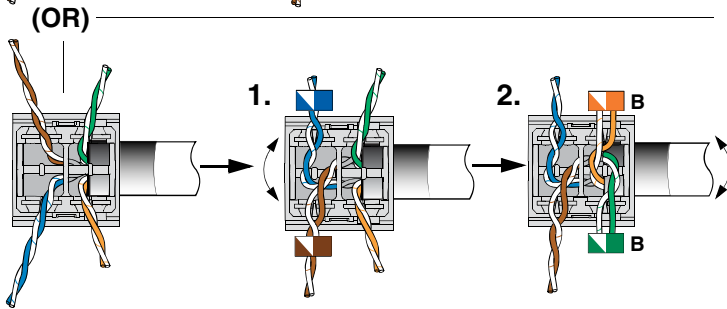
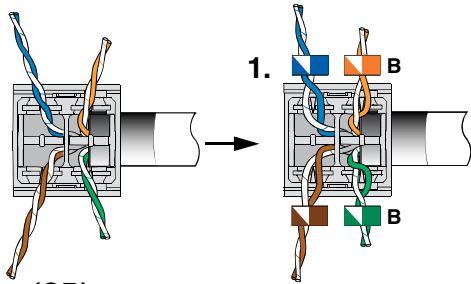
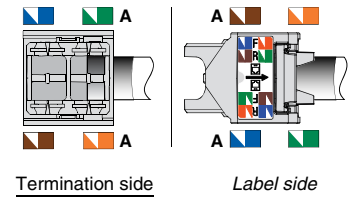

8

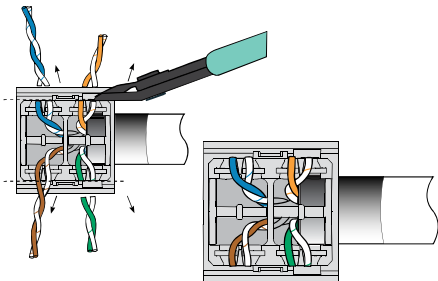

9

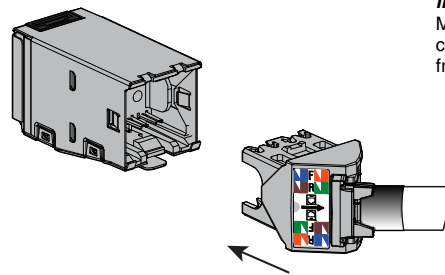

**Important!**  
Maintain orientation of cap in relation to jack from previous steps.

10

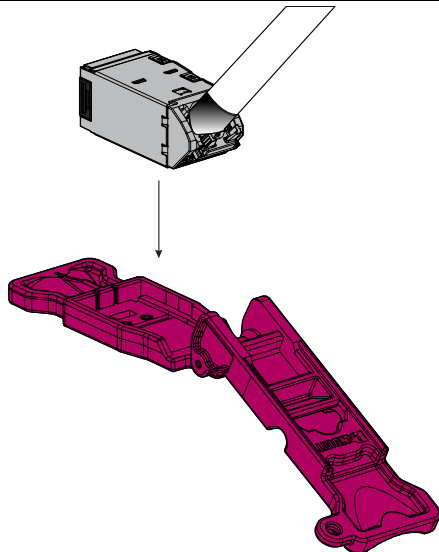

11

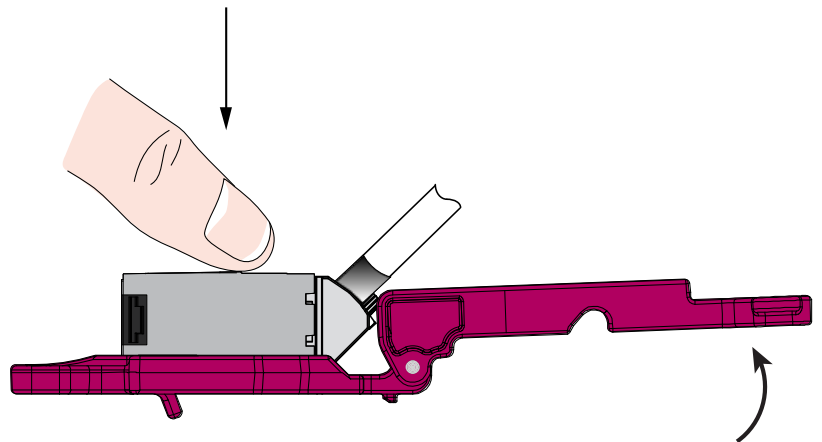

### Right Orientation

1

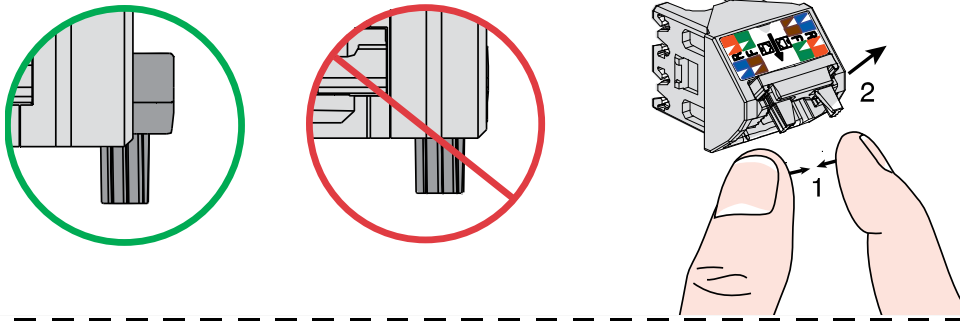

### IMPORTANT!:

Be sure that strain relief is fully retracted before inserting cable.

2

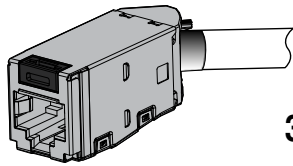
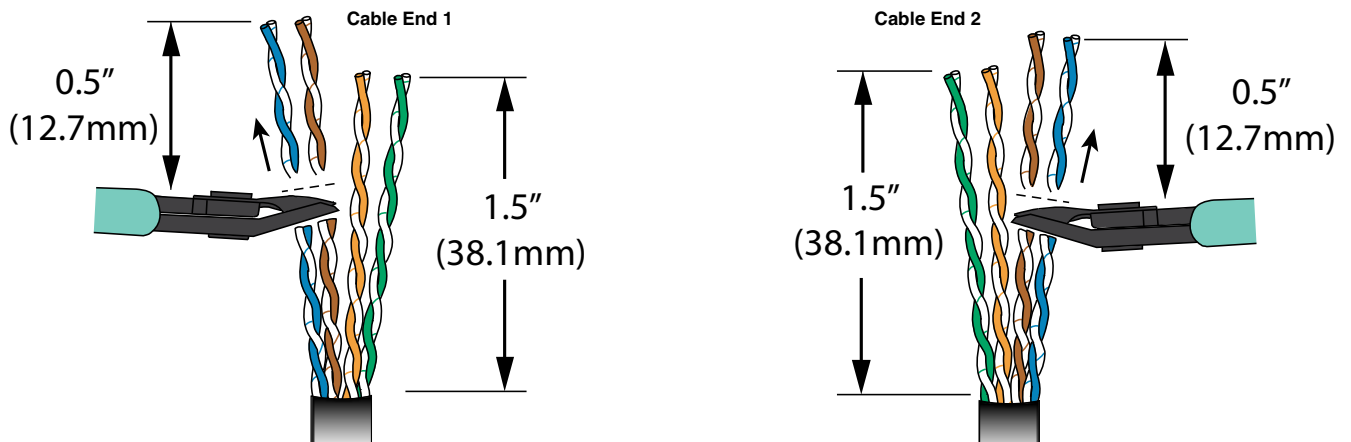

Do not pre-arrange conductors.

3

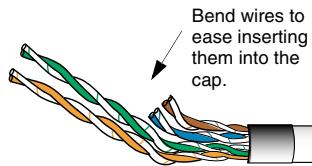

Bend wires to ease inserting them into the cap.

4

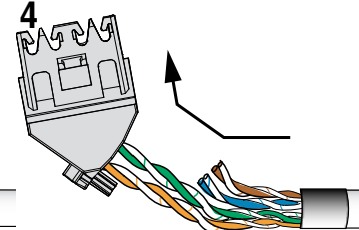

Cable End 1 Shown

5

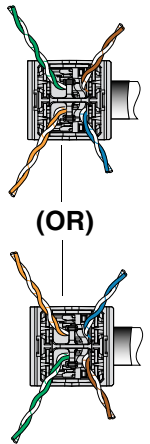
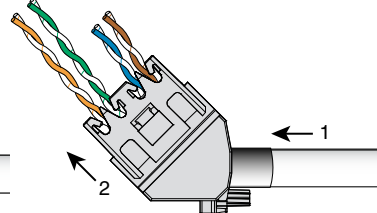

6

Be sure cable is fully inserted into wire cap

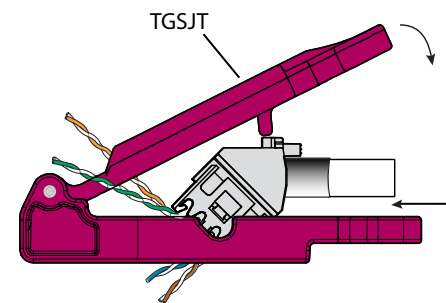
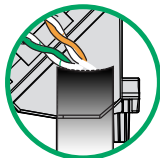
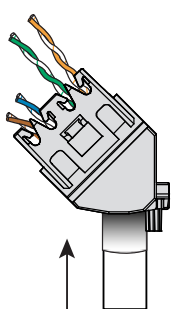

Cable End 1 Shown

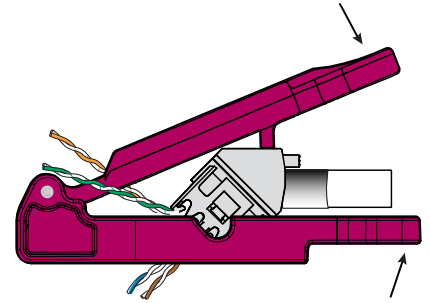

### Right Orientation

7

### T568B Wiring

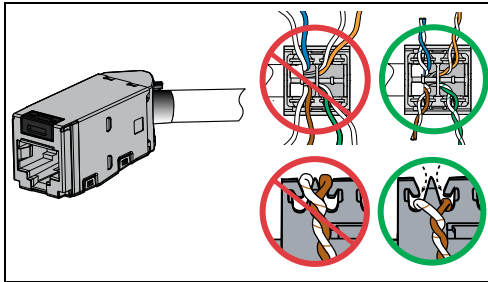
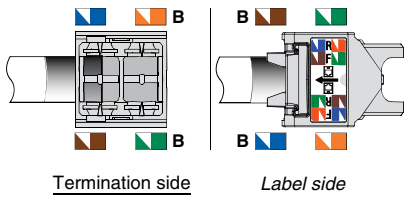

### T568A Wiring

T568A not shown on wire map label

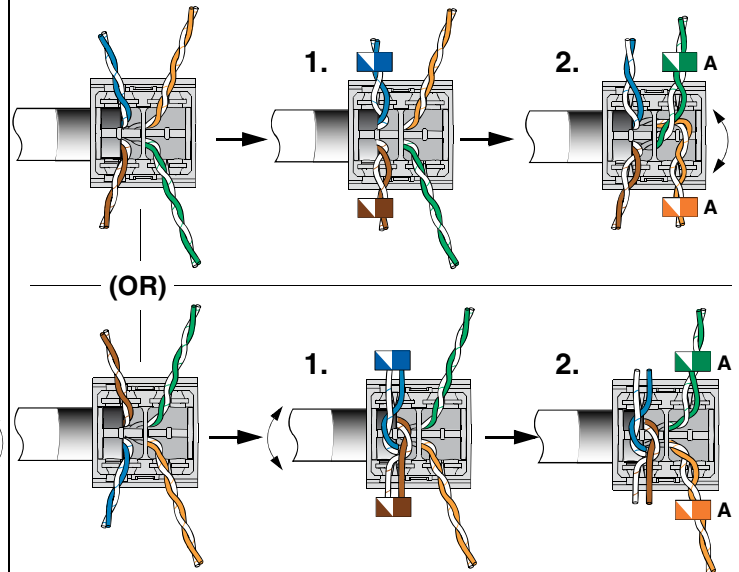
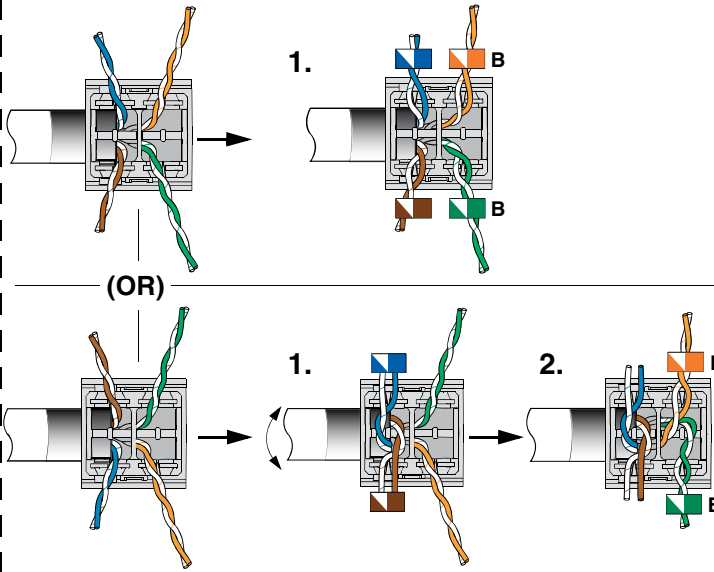
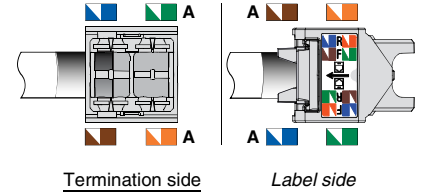

8

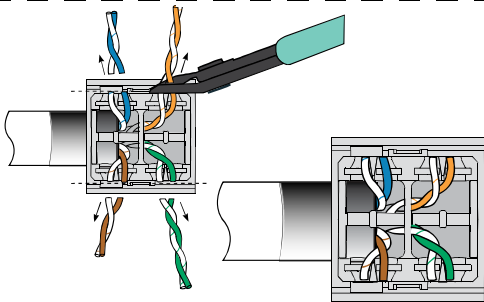

9

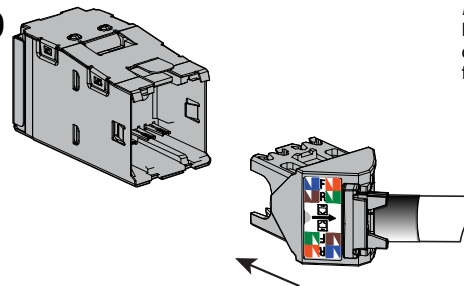

**Important!**  
Maintain orientation of cap in relation to jack from previous steps.

10

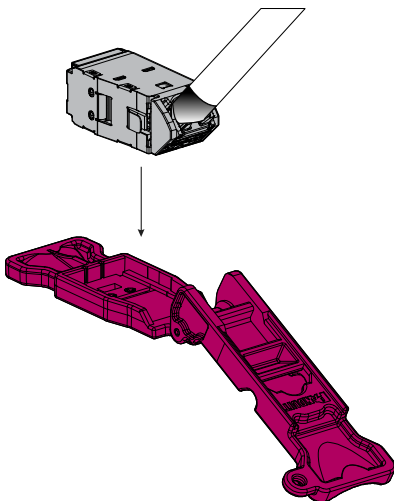

11

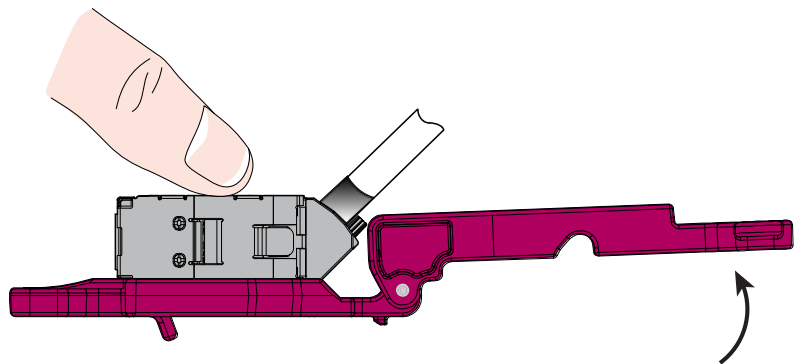

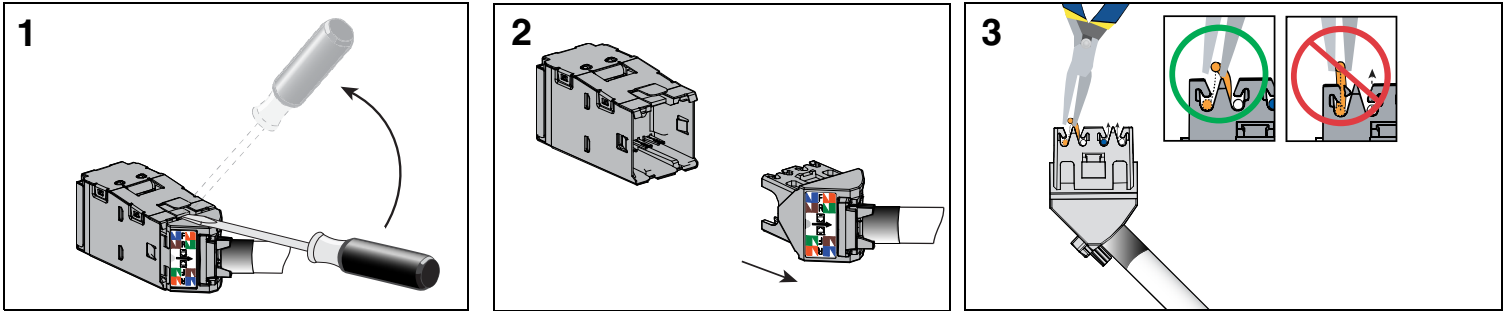
**REMOVAL STEPS****Notes:**

1. For specified performance, follow TIA/EIA 568-C installation guidelines.
2. Jack Modules can terminate 22-26 AWG solid data cable with 0.062" (1.57mm) maximum insulated conductor outside diameter.
3. Jack Modules may be re-terminated at least 20 times.
4. For technical and performance information, consult Panduit Technical Support.

**As with all Wiring Accessories, the following statements apply:**

1. Never install communications wiring during a lightning storm.
2. Never install communications wiring in wet locations unless the jack is specifically designed for use in wet locations.
3. Never touch uninsulated communications wiring or terminals unless the communication line has been disconnected at the network interface.
4. Use caution when installing or modifying communication wiring.

For Instructions in Local Languages  
and Technical Support:

[www.panduit.com/resources/install\\_maintain.asp](http://www.panduit.com/resources/install_maintain.asp)

**PANDUIT**

[www.panduit.com](http://www.panduit.com)

**E-mail:**  
[techsupport@panduit.com](mailto:techsupport@panduit.com)

**Phone:**  
866-405-6654