

type	code article	pcs
15-009	0253 0001 010	100
15-043	0253 0004 010	100
15-045	0253 0005 010	100
15-049	0253 0008 010	50
15-083	0253 0013 010	25
15-130	0253 0014 010	50
15-131	0253 0015 010	50
15-147	0253 0016 010	50
15-159	0253 0017 010	100
15-164	0253 0018 010	50
15-169	0253 0019 010	100
15-170	0253 0020 010	100
15-171	0253 0021 010	100
15-172	0253 0022 010	100
15-190	0256 0010 010	100
15-306	0253 0057 010	100
15-318	0253 0058 010	100
15-320	0253 0059 010	25
15-329**	0253 0060 010	25
15-354	0253 0061 010	100
15-380	0253 0062 010	100
15-383	0253 0056 010	100
15-391	0253 0063 010	100
15-401	0256 0001 010	100
15-402	0256 0002 010	100

type	code article	pcs
15-403	0256 0003 010	100
15-405	0256 0005 010	100
15-410	0253 0051 010	100
15-411	0253 0052 010	50
15-412	0253 0053 010	50
15-538	0253 0064 010	100
15-561	0253 0065 010	100
15-579	0253 0066 010	50
15-592	0253 0070 010	50
15-596*	0253 0071 010	100
15-602**	0253 0072 010	50
15-608	0253 0073 010	100
15-625	0252 0319 010	100
15-633	0253 0077 010	50
15-642	0253 0078 010	100
15-643	0253 0079 010	50
15-649	0253 0075 010	100
15-651	0253 0076 010	100
15-672	0253 0092 010	50
15-680	0253 0095 010	100
15-691**	0253 0110 010	100
15-692**	0253 0111 010	50

type	code article	pcs
15-693**	0253 0112 010	50
15-721	0253 0003 010	100
15-737	0253 0080 010	50
15-747	0253 0083 010	50
15-748	0253 0084 010	50
15-751	0253 0091 010	50
15-756	0253 0085 010	50
15-760	0253 0113 010	100
15-781	0253 0087 010	50
15-806	0253 0114 010	100
15-821	0253 0115 010	100
15-822	0253 0117 010	100
15-832	0253 0118 010	100
15-833	0253 0119 010	100
15-834	0253 0120 010	100
15-836	0253 0121 010	100

**Bride métallique de serrage** pour protecteur 15-412

**16-900** 0684 0054 000 100

\*caoutchouc Nitrile - \*\*caoutchouc EPDM

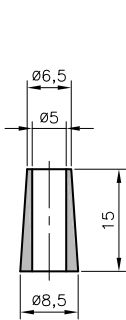

**15-009**  
0253 0001 010

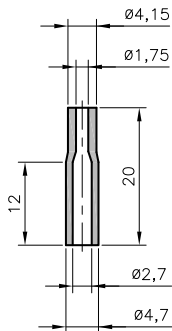

**15-190**  
0256 0010 010

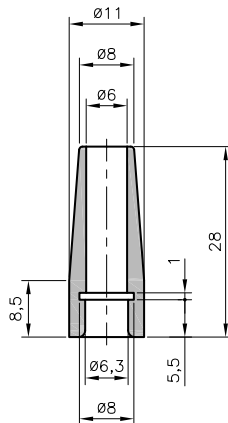

**15-318**  
0253 0058 010

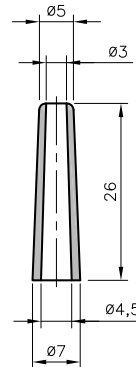

**15-401**  
0256 0001 010

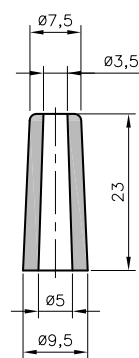

**15-402**  
0256 0002 010

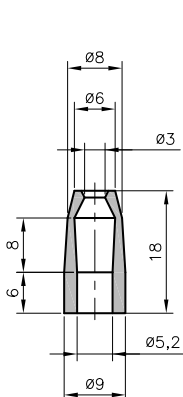

**15-403**  
0256 0003 010

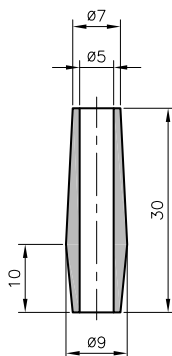

**15-405**  
0256 0005 010

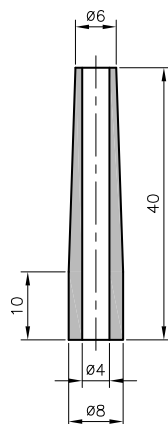

**15-680**  
0253 0095 010

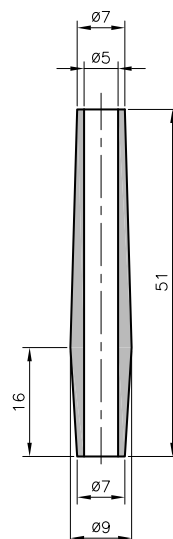

**15-043**  
0253 0004 010

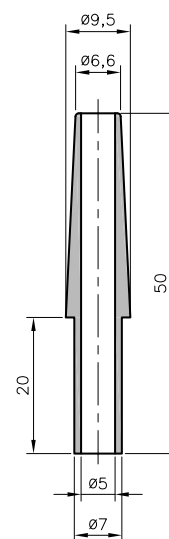

**15-380**  
0253 0062 010

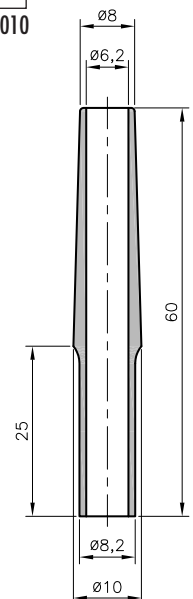

**15-391**  
0253 0063 010

**Protecteurs**  
en caoutchouc polychloroprène noir



HELAVIA®

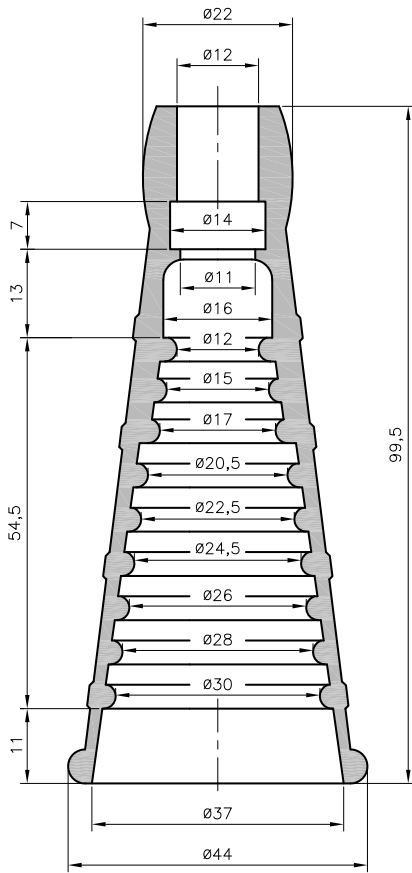

**15-329**  
0253 0060 010

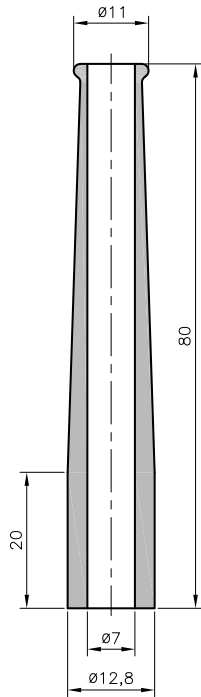

**15-164**  
0253 0018 010

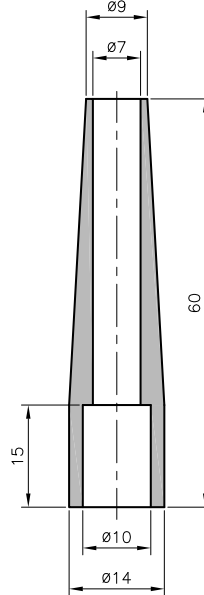

**15-045**  
0253 0005 010

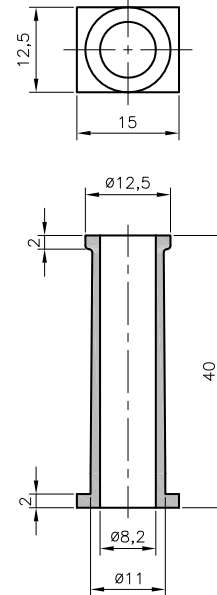

**15-642**  
0253 0078 010

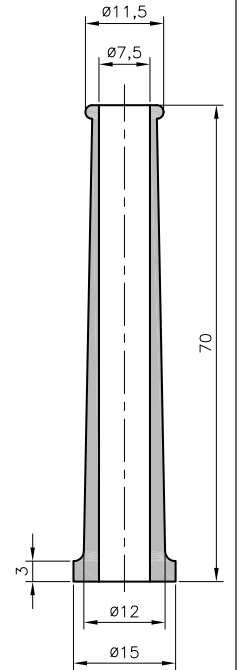

**15-411**  
0253 0052 010

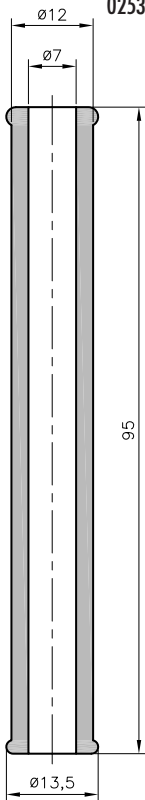

**15-169**  
0253 0019 010

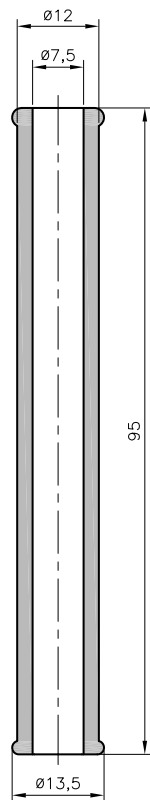

**15-170**  
0253 0020 010

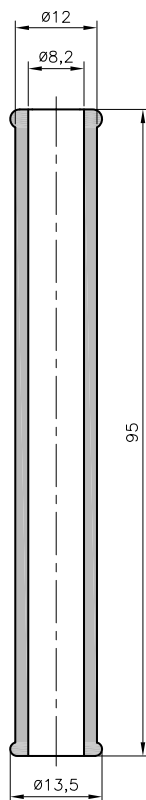

**15-171**  
0253 0021 010

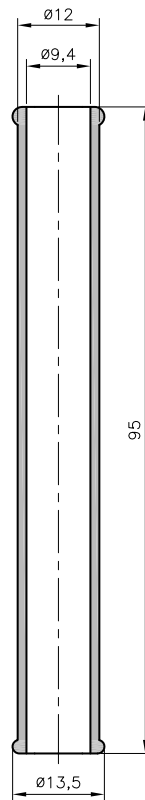

**15-172**  
0253 0022 010

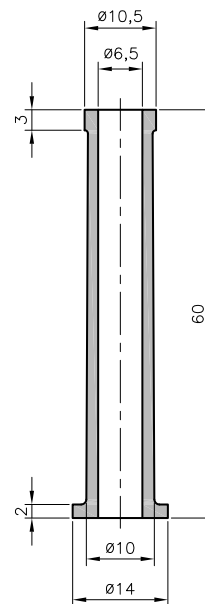

**15-538**  
0253 0064 010

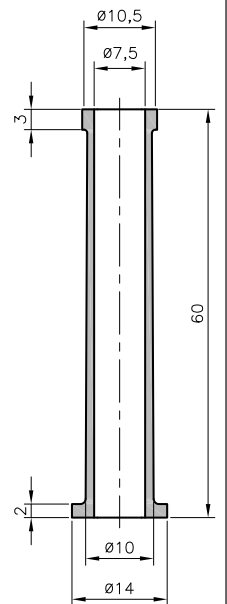

**15-579**  
0253 0066 010



**Protecteurs  
en caoutchouc polychloroprène noir**



**HELAVIA®**

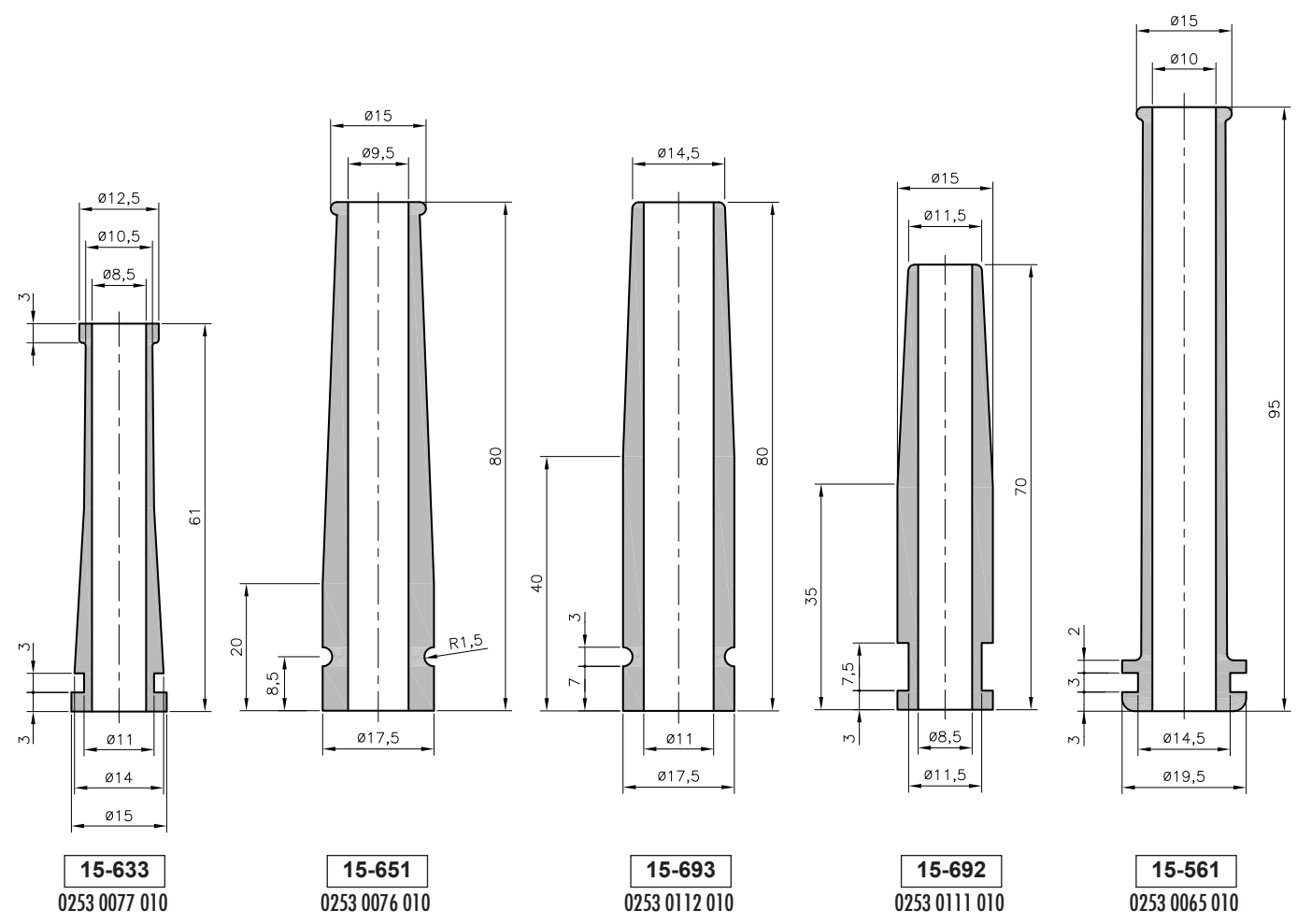
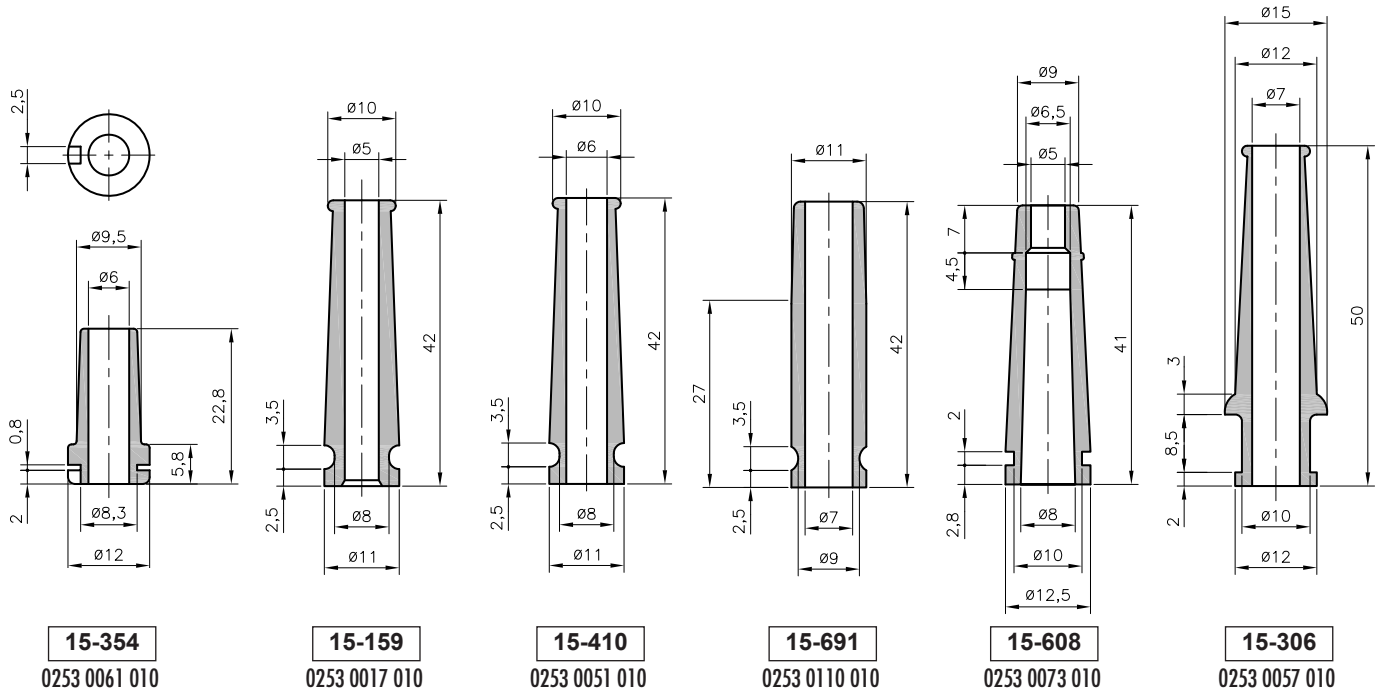

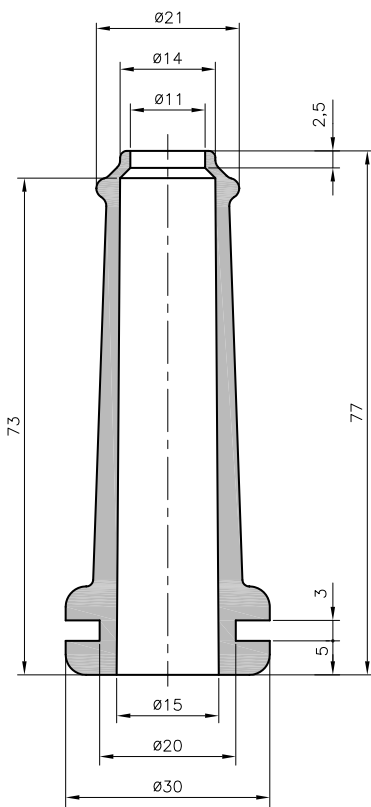

**15-049**  
0253 0008 010

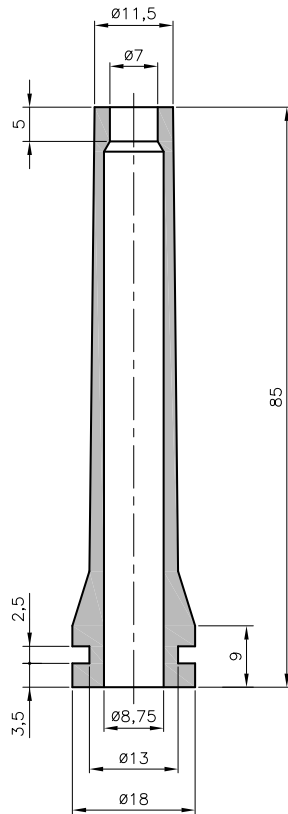

**15-131**  
0253 0015 010

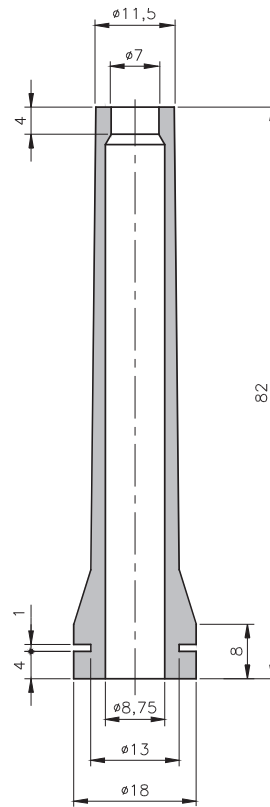

**15-672**  
0253 0092 010

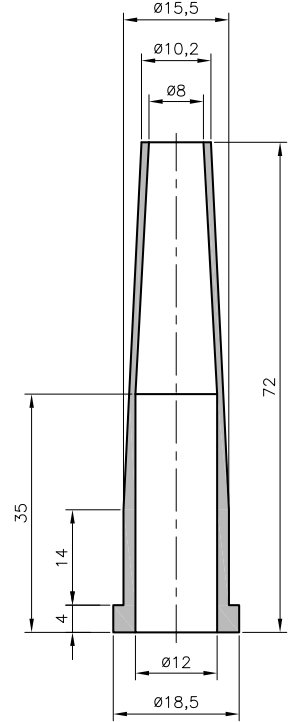

**15-147**  
0253 0016 010

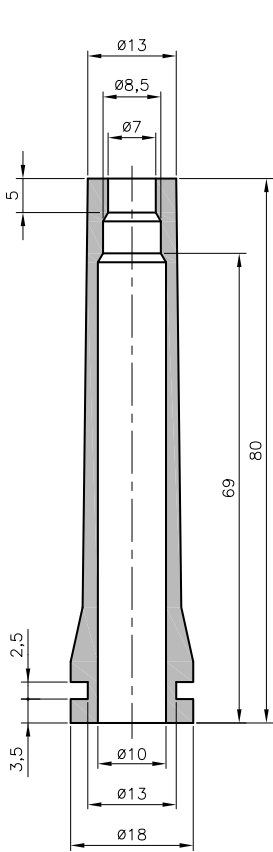

**15-643**  
0253 0079 010

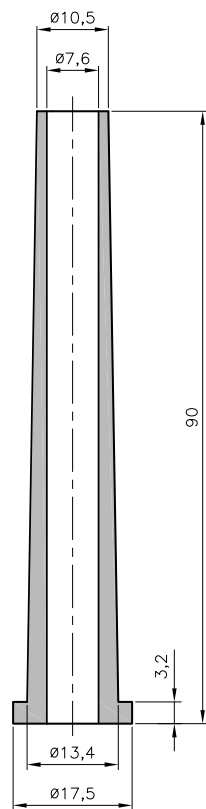

**15-602**  
0253 0072 010

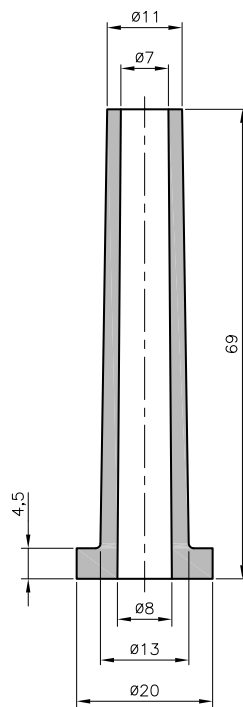

**15-592**  
0253 0070 010

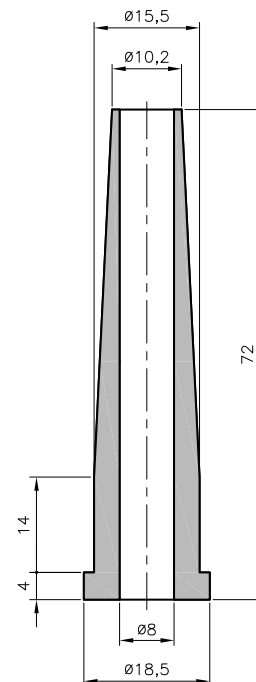

**15-130**  
0253 0014 010

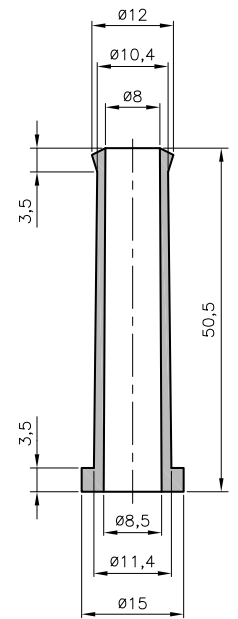

**15-383**  
0253 0056 010

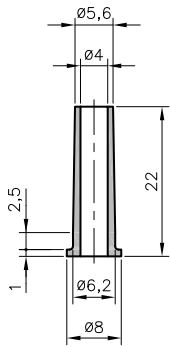

**15-649**  
0253 0075 010

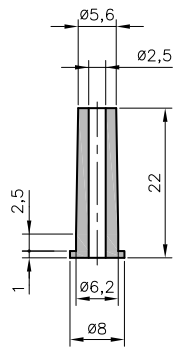

**15-760**  
0253 0113 010

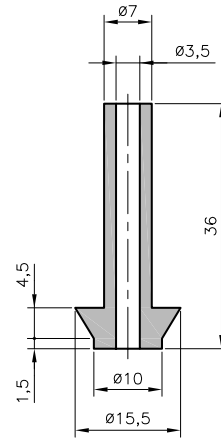

**15-596**  
0253 0071 010

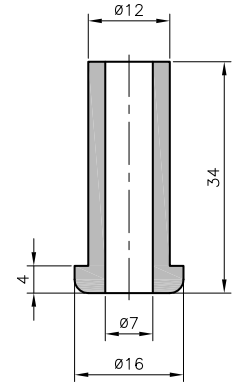

**15-625**  
0252 0319 010

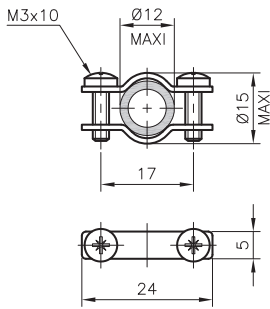

**16-900**  
0684 0054 000

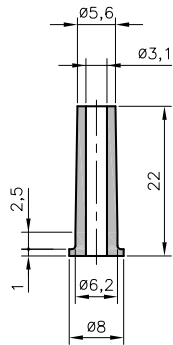

**15-721**  
0253 0003 010

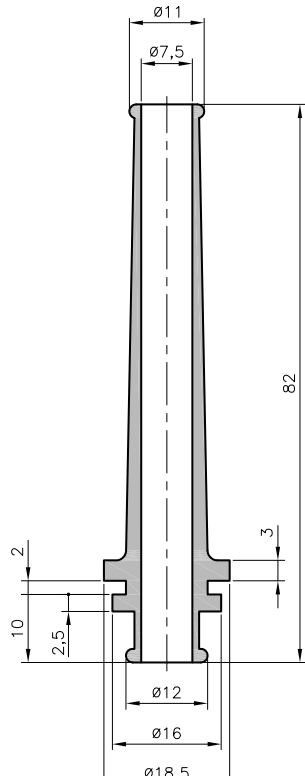

**15-412**  
0253 0053 010

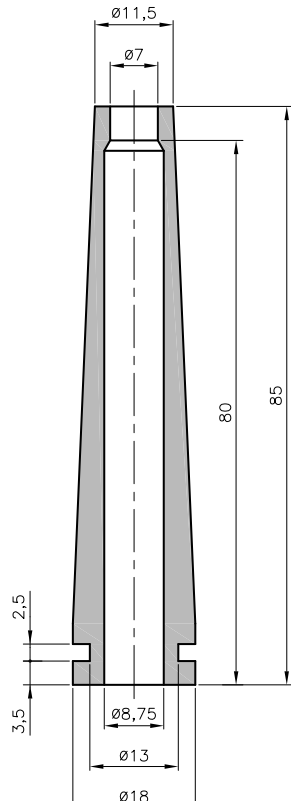

**15-751**  
0253 0091 010

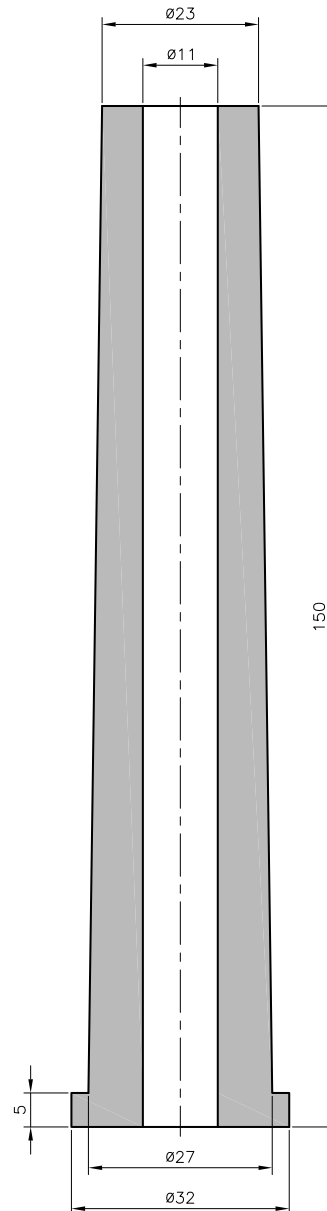

**15-320**  
0253 0059 010

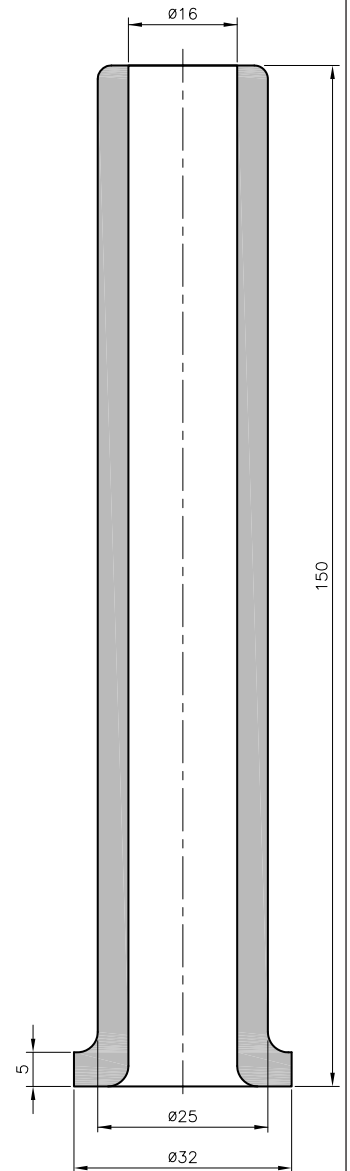

**15-083**  
0253 0013 010

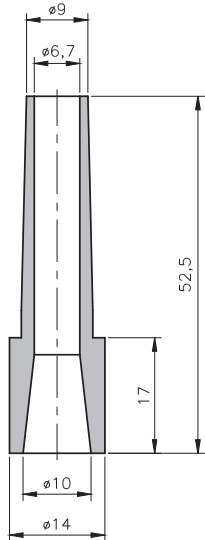

**15-822**  
0253 0117 010

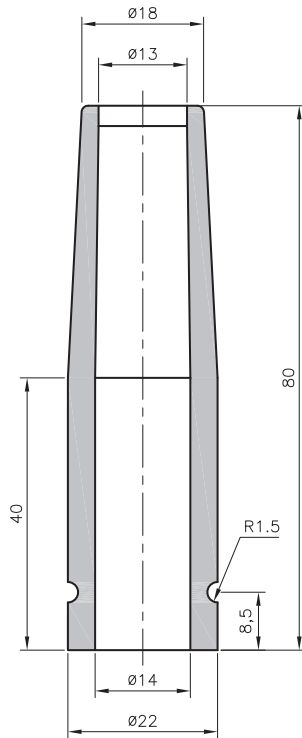

**15-747**  
0253 0083 010

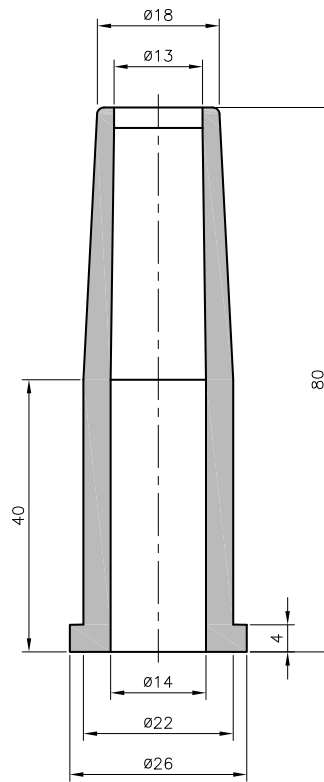

**15-748**  
0253 0084 010

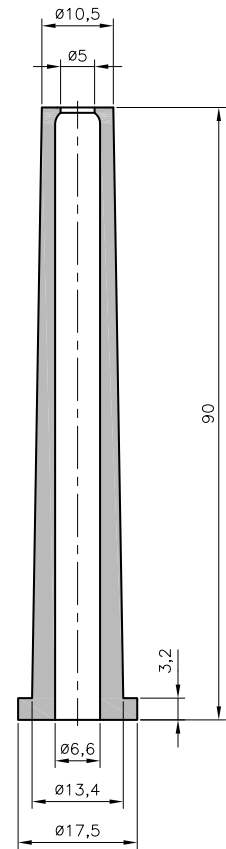

**15-756**  
0253 0085 010

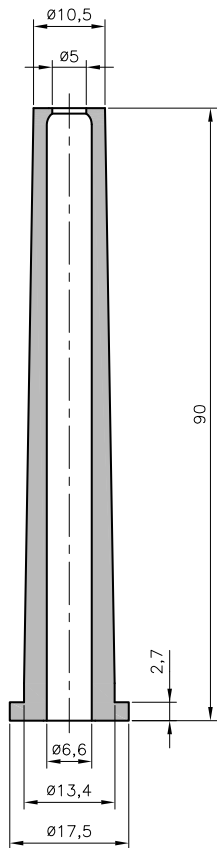

**15-781**  
0253 0087 010

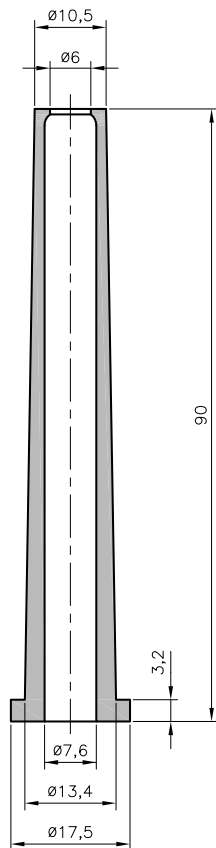

**15-737**  
0253 0080 010

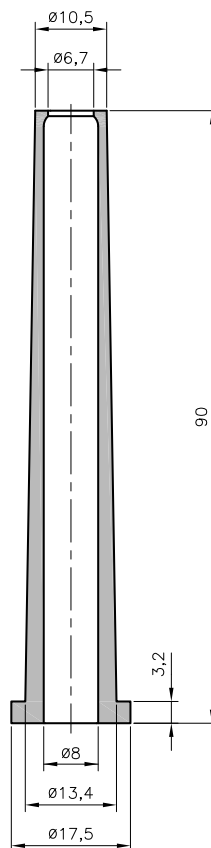

**15-806**  
0253 0114 010

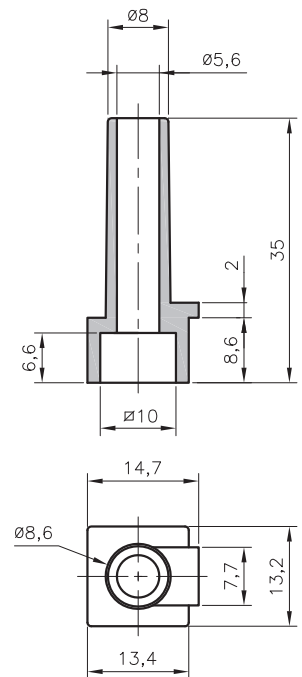

**15-821**  
0253 0115 010

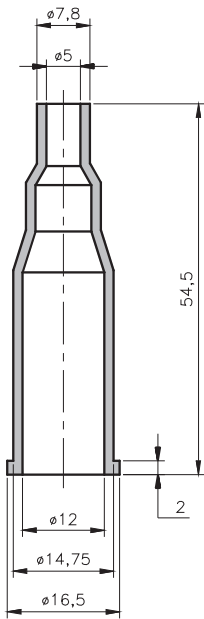

**15-832**  
0253 0118 010

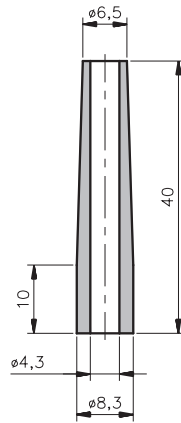

**15-833**  
0253 0119 010

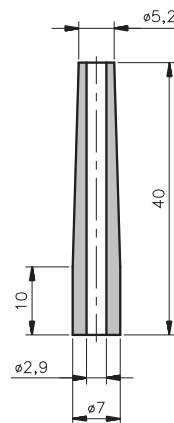

**15-834**  
0253 0120 010

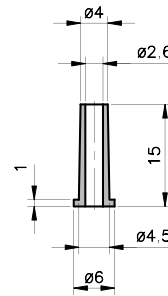

**15-836**  
0253 0121 010