



Product designation
Product type designation

Power contactor
BGF09

Contact characteristics

Number of poles	Nr.	3
Rated insulation voltage U_i IEC/EN	V	690
Rated impulse withstand voltage U_{imp}	kV	6
Operational frequency	min	Hz 25
	max	Hz 400
IEC Conventional free air thermal current I_{th}	A	20
Operational current I_e	AC-1 ($\leq 40^\circ\text{C}$)	A 20
	AC-1 ($\leq 55^\circ\text{C}$)	A 18
	AC-1 ($\leq 70^\circ\text{C}$)	A 15
	AC-3 ($\leq 440\text{V} \leq 55^\circ\text{C}$)	A 9
	AC-4 (400V)	A 4
Rated operational power AC-3 ($T \leq 55^\circ\text{C}$)	230V	kW 2.2
	400V	kW 4
	415V	kW 4.3
	440V	kW 4.5
	500V	kW 5
	690V	kW 5
Rated operational power AC-1 ($T \leq 40^\circ\text{C}$)	230V	kW 8
	400V	kW 14
	500V	kW 16
	690V	kW 22
IEC max current I_e in DC1 with $L/R \leq 1\text{ms}$ with 1 poles in series	$\leq 24\text{V}$	A 12
	48V	A 10
	75V	A 4
	110V	A 3
	220V	A –
IEC max current I_e in DC1 with $L/R \leq 1\text{ms}$ with 2 poles in series	$\leq 24\text{V}$	A 15
	48V	A 14
	75V	A 9
	110V	A 8
	220V	A –
IEC max current I_e in DC1 with $L/R \leq 1\text{ms}$ with 3 poles in series	$\leq 24\text{V}$	A 16
	48V	A 16
	75V	A 10
	110V	A 10
	220V	A 2

IEC max current I_e in DC1 with $L/R \leq 1\text{ms}$ with 4 poles in series

$\leq 24\text{V}$	A	16
48V	A	16
75V	A	10
110V	A	10
220V	A	2

IEC max current I_e in DC3-DC5 with $L/R \leq 15\text{ms}$ with 1 poles in series

$\leq 24\text{V}$	A	7
48V	A	6
75V	A	2
110V	A	1
220V	A	–

IEC max current I_e in DC3-DC5 with $L/R \leq 15\text{ms}$ with 2 poles in series

$\leq 24\text{V}$	A	8
48V	A	8
75V	A	5
110V	A	4
220V	A	–

IEC max current I_e in DC3-DC5 with $L/R \leq 15\text{ms}$ with 3 poles in series

$\leq 24\text{V}$	A	10
48V	A	10
75V	A	6
110V	A	5
220V	A	0,8

IEC max current I_e in DC3-DC5 with $L/R \leq 15\text{ms}$ with 4 poles in series

$\leq 24\text{V}$	A	10
48V	A	10
75V	A	6
110V	A	5
220V	A	0,8

Short-time allowable current for 10s (IEC/EN60947-1)

A	96
---	----

Protection fuse

gG (IEC)	A	20
aM (IEC)	A	10

Making capacity (RMS value)

A	92
---	----

Breaking capacity at voltage

440V	A	72
500V	A	72
690V	A	72

Resistance per pole (average value)

$\text{m}\Omega$	10
------------------	----

Power dissipation per pole (average value)

I_{th}	W	4
AC-3	W	0.81

Tightening torque for terminals

min	Nm	0.8
max	Nm	1
min	Ibin	9
max	Ibin	9

Tightening torque for coil terminal

min	Nm	0.8
max	Nm	1
min	Ibin	9
max	Ibin	9

Max number of wires simultaneously connectable	Nr.	2	
Conductor section	AWG/Kcmil		
	max	12	
Flexible w/o lug conductor section	min	mm ²	0.75
	max	mm ²	2.5
Flexible c/w lug conductor section	min	mm ²	1.5
	max	mm ²	2.5
Flexible with insulated spade lug conductor section	min	mm ²	1.5
	max	mm ²	2.5
Power terminal protection according to IEC/EN 60529	IP20 when properly wired		
Mechanical features			
Operating position	normal allowable	Vertical plan ±30°	
Fixing	Screw / DIN rail 35mm		
Weight	g	224	
Conductor section	AWG/kcmil conductor section		
	max	12	
Auxiliary contact characteristics			
Thermal current I _{th}	A	10	
IEC/EN 60947-5-1 designation	A600 - Q600		
Operating current AC15	230V	A	3
	400V	A	1.9
	500V	A	1.4
Operating current DC12	110V	A	2.9
Operating current DC13	24V	A	2.9
	48V	A	1.4
	60V	A	1.1
	125V	A	0.3
	220V	A	0.1
	600V	A	0.6
Operations			
Mechanical life	cycles	20000000	
Electrical life	cycles	500000	
Safety related data			
Performance level B10d according to EN/ISO 13489-1	rated load	cycles	500000
	mechanical load	cycles	20000000
Mirror contacts according to IEC/EN 60947-4-1	yes		
EMC compatibility	yes		
DC coil operating			
DC rated control voltage	V	125	
DC operating voltage			

pick-up	min	%Us	75
	max	%Us	115
<hr/>			
drop-out	min	%Us	10
	max	%Us	25

Average coil consumption $\leq 20^{\circ}\text{C}$

in-rush	W	3.2
holding	W	3.2

Max cycles frequency

Mechanical operation	cycles/h	3600
----------------------	----------	------

Operating times

Average time for Us control

in AC

Closing NO

min	ms	12
max	ms	21

Opening NO

min	ms	9
max	ms	18

Closing NC

min	ms	17
max	ms	26

Opening NC

min	ms	7
max	ms	17

in DC

Closing NO

min	ms	18
max	ms	25

Opening NO

min	ms	2
max	ms	3

Closing NC

min	ms	3
max	ms	5

Opening NC

min	ms	11
max	ms	17

UL technical data

Full-load current (FLA) for three-phase AC motor

at 480V	A	7.6
at 600V	A	6.1

Yielded mechanical performance

for single-phase AC motor

110/120V	HP	0.5
230V	HP	1.5

for three-phase AC motor

200/208V	HP	2
220/230V	HP	3
460/480V	HP	5
575/600V	HP	5

General USE

Contactor

	AC current	A	20
Short-circuit protection fuse, 600V High fault	Short circuit current	kA	100
	Fuse rating	A	30
	Fuse class		J
Standard fault	Short circuit current	kA	5
	Fuse rating	A	30
Contact rating of auxiliary contacts according to UL			A600 - Q600

Ambient conditions

Temperature

Operating temperature

min	°C	-50
max	°C	+70

Storage temperature

min	°C	-60
max	°C	+80

Max altitude

m	3000
---	------

Resistance & Protection

Pollution degree

3

Dimensions

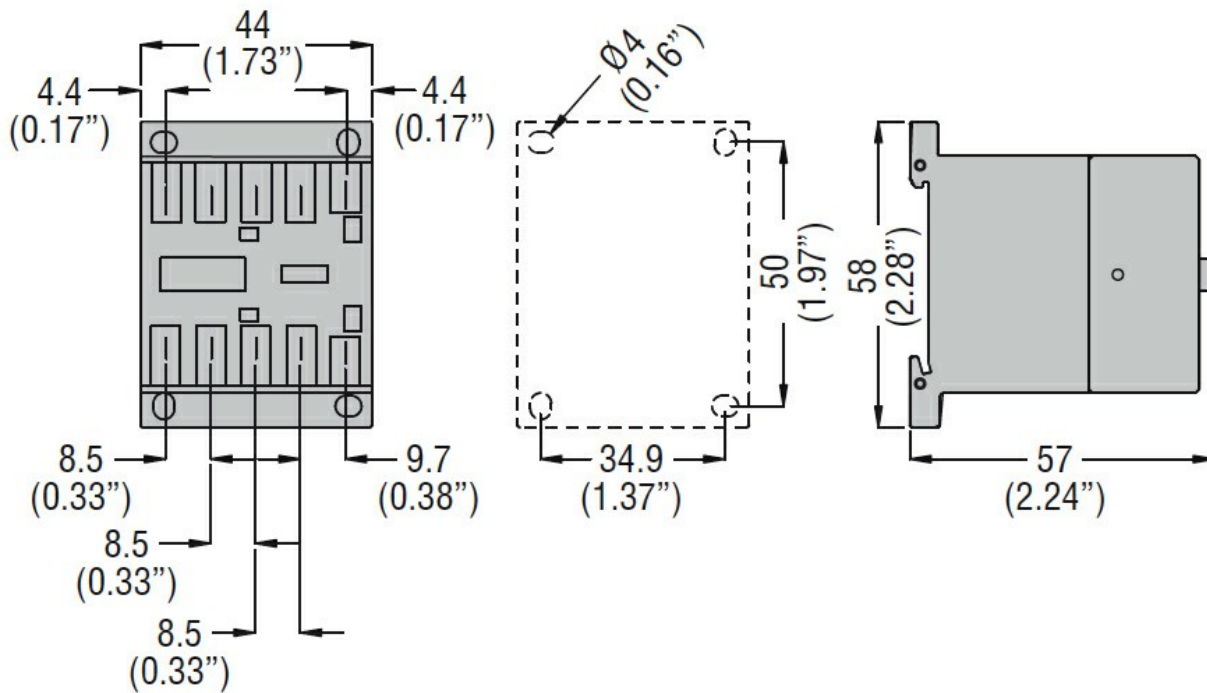

Wiring diagrams

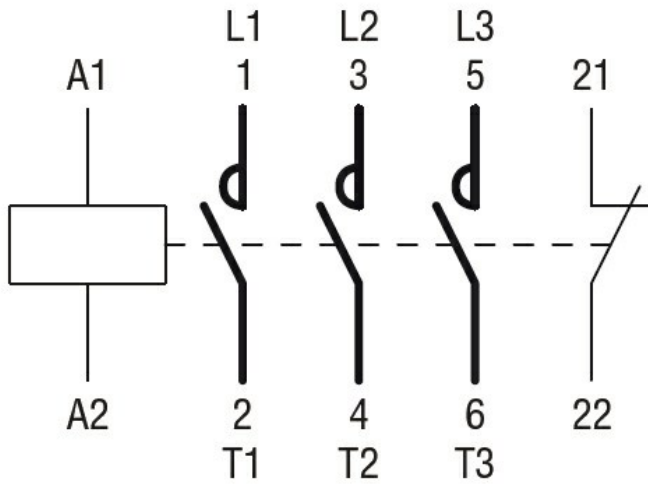

Certifications and compliance

Compliance

CSA C22.2 n° 60947-1

CSA C22.2 n° 60947-4-1

IEC/EN 60947-1

IEC/EN 60947-4-1

UL 60947-1

UL 60947-4-1

Certificates

CCC

cULus

EAC

ETIM classification

ETIM 8.0

EC000066 -
Power contactor,
AC switching