



DT500-A623

Dx500

LONG RANGE DISTANCE SENSORS

SICK
Sensor Intelligence.



Ordering information

Type	Part no.
DT500-A623	1040473

Other models and accessories → www.sick.com/Dx500



Detailed technical data

Mechanics/electronics

Supply voltage V_s	DC 10 V ... 30 V, reverse polarity protected $U_V \geq$ DC 24 V for devices with heating
Ripple	5 V _{pp} ¹⁾
Power consumption	Typ. 22 W
Initialization time	500 ms
Housing material	Metal (Aluminum die cast)
Window material	Glass
Connection type	Male connector, M12, 8-pin
Weight	1,000 g
Dimensions (W x H x D)	69 mm x 50 mm x 153 mm
Enclosure rating	IP65
Protection class	II ²⁾

¹⁾ May not fall short of or exceed V_s tolerances.

²⁾ Reference voltage DC 32 V.

Safety-related parameters

MTTF_D	101 years
DC_{avg}	0%

Performance

Measurement range min ... max:	0.2 m ... 70 m, 90% remission factor ^{1) 2)} 0.2 m ... 30 m, 6% remission factor ^{1) 2)}
Target	Natural objects
Resolution	≤ 0.1 mm
Repeatability	1 mm ^{3) 4)}
Accuracy	± 3 mm

¹⁾ In ambient light, max. 1 klx of constant light.

²⁾ Unique up to 150 m.

³⁾ 6% ... 90% remission factor.

⁴⁾ Statistical error 1 σ .

⁵⁾ Average service life of 50,000 h at $T_A = +25$ °C.

Response time	≥ 150 ms
Output time	150 ms ... 6,000 ms
Light source	Laser, red ⁵⁾ visible red light
Laser class	2, complies with 21 CFR 1040.10 and 1040.11 except for the conformance according to "Laser Notice No. 50" from June 24, 2007 (IEC 60825-1:2014, EN 60825-1:2014)
Typ. light spot size (distance)	10 mm (at 7 m) 45 mm (at 30 m) 100 mm (at 70 m)
Heating	✓

- 1) In ambient light, max. 1 klx of constant light.
 2) Unique up to 150 m.
 3) 6% ... 90% remission factor.
 4) Statistical error 1 σ .
 5) Average service life of 50,000 h at $T_A = +25$ °C.

Interfaces

CAN	✓
Remark	Layer 2
Multifunctional input (MF)	PNP ^{1) 2)}
Laser-off input	> 12 V

- 1) Refer to function MF input.
 2) HIGH = UV - (< 2 V) / LOW = < 2 V; active HIGH.

Ambient data

Electromagnetic compatibility (EMC)	EN 61000-6-2, EN 55011 EN 60947-5-7: 2003-9
Ambient temperature, operation	-40 °C ... +45 °C, operation with heating -40 °C ... +75 °C, operation with cooling case
Ambient temperature, storage	-25 °C ... +75 °C
Temperature drift	Typ. 0.05 mm/K
Typ. Ambient light immunity	≤ 3,000 lx
Mechanical load	Shock: (EN 600 68-2-27 / -2-29) Sine: (EN 600 68-2-6) Noise: (EN 600 68-2-64)

Classifications

eCl@ss 5.0	27270801
eCl@ss 5.1.4	27270801
eCl@ss 6.0	27270801
eCl@ss 6.2	27270801
eCl@ss 7.0	27270801
eCl@ss 8.0	27270801
eCl@ss 8.1	27270801
eCl@ss 9.0	27270801
eCl@ss 10.0	27270801
eCl@ss 11.0	27270801
eCl@ss 12.0	27270916

ETIM 5.0	EC001825
ETIM 6.0	EC001825
ETIM 7.0	EC001825
ETIM 8.0	EC001825
UNSPSC 16.0901	41111613

Dimensional drawing (Dimensions in mm (inch))

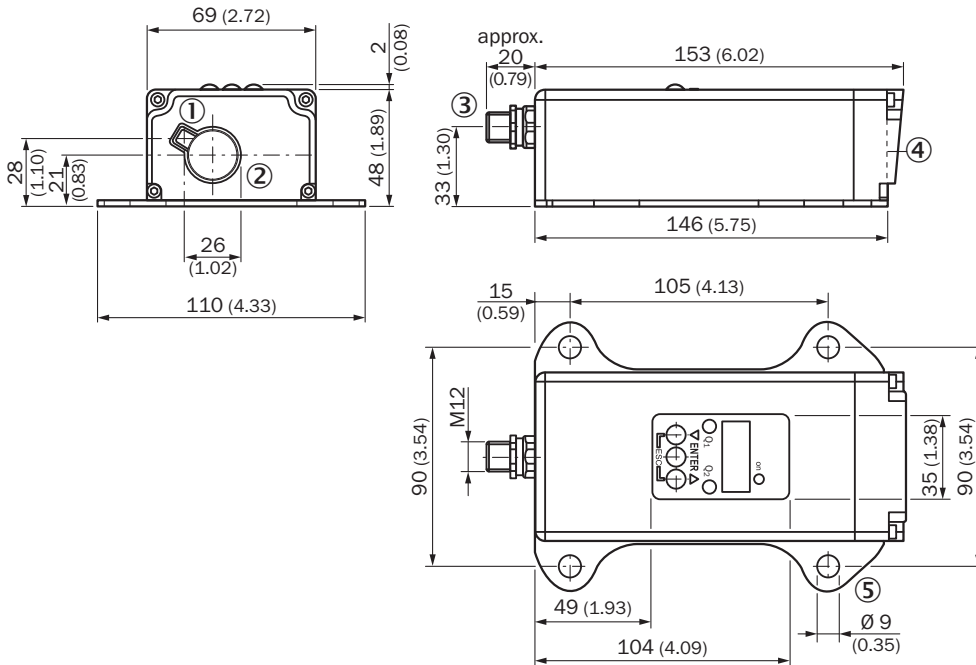

- ① Optical axis, sender
- ② Optical axis, receiver
- ③ Male connector M12, 5-pin
- ④ Zero level
- ⑤ Fixing hole

Connection type

DT500-Axx3 CAN (Layer 2) Connector M12, 8-pin

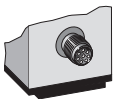

Connection diagram

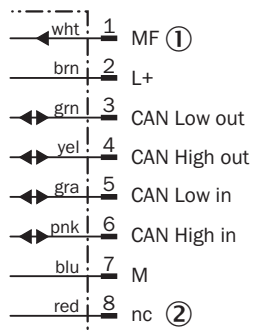

- ① Multifunctional input (MF)
- ② Not assigned

Adjustment possible

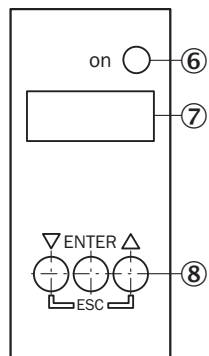

- ⑥ Operating indicator
- ⑦ Indicator panel, 7-segment display
- ⑧ Control panel

Functional principle

Additional information

Extern Teach ET via MF ①

Teach-in	MF active	Model
0 mA	100 ms	Current measurement value is used
4 mA	200 ms	
20 mA	300 ms	
Laser off	> 450 ms	

① Multi functional input.

Error performance or no object in measurement range

Measurement not possible

Measurement value output display	Analog interface	CAN Bus	Serial interface
0.000	0/3.5 mA	00000	00000 CRLF

No object in measurement range or laser off

Measurement value output display	Analog interface	CAN Bus	Serial interface
99.99	20.5 mA	99999	99999 CRLF



Function MF input

Function MF input

Teach in	0 mA	60 ms < MF < 150 ms
Teach in	4 mA	150 ms < MF < 250 ms
Teach in	20 mA	250 ms < MF < 350 ms
Laser off	-	450 ms < MF < ∞

Recommended accessories

Other models and accessories → www.sick.com/Dx500

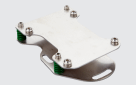
	Brief description	Type	Part no.
Plug connectors and cables			
	Head A: female connector, M12, 8-pin, straight Head B: Flying leads Cable: PUR, halogen-free, shielded, 5 m	YF2A68-050XXXLEAX	6032449
	Head A: female connector, M12, 8-pin, straight Cable: shielded	DOS-1208-GA	6028369
Terminal and alignment brackets			
	Alignment unit for DS/DT500, stainless steel (1.4541), incl. mounting material, mounting hardware included	BEF-DSDT	2031377

SICK AT A GLANCE

SICK is one of the leading manufacturers of intelligent sensors and sensor solutions for industrial applications. A unique range of products and services creates the perfect basis for controlling processes securely and efficiently, protecting individuals from accidents and preventing damage to the environment.

We have extensive experience in a wide range of industries and understand their processes and requirements. With intelligent sensors, we can deliver exactly what our customers need. In application centers in Europe, Asia and North America, system solutions are tested and optimized in accordance with customer specifications. All this makes us a reliable supplier and development partner.

Comprehensive services complete our offering: SICK LifeTime Services provide support throughout the machine life cycle and ensure safety and productivity.

For us, that is “Sensor Intelligence.”

WORLDWIDE PRESENCE:

Contacts and other locations –www.sick.com