

PViQ Hardware User Manual

PViQ Hardware User Manual 450-081-ENG

Copyright © 2017 Panduit Corporation All rights reserved. No part of this book shall be reproduced, stored in a retrieval system, or transmitted by any means, electronic, mechanical, photocopying, recording or otherwise, without written permission from Panduit. No patent liability is assumed with respect to the use of the information contained herein.

Although every precaution has been taken in the preparation of this book, Panduit assumes no responsibility for errors or omissions. Neither is any liability assumed for damages resulting from the use of the information contained herein.

PANDUIT

SAFETY WARNING

Always observe standard safety precautions during installation, operation and maintenance of this product. Read the installation instructions before connecting the unit to its power source. There are no user serviceable parts inside the unit. To avoid the possibility of electric shock, the user should not perform any adjustment, maintenance or repairs, or open the unit. Do not work on the product or connect or disconnect cables during periods of lightning activity. Ultimate disposal of this product should be handled according to all national laws and regulations.

WARRANTY

Unless otherwise specified, all products presented in this User Guide are warranted against defects in material and workmanship for a period of one year from the date of sale to the initial purchaser. Panduit Corporation warrants that its firmware designed by Panduit Corporation for use with the product will execute its functions when properly installed in the product for one year from the date of sale to the initial purchaser. Panduit Corporation does not warrant that the operation of the product or the firmware will be uninterrupted or error-free. During the warranty period Panduit Corporation will, at its discretion, either repair or replace products that prove to be defective. For warranty service or repair, the product claimed to be defective must be returned to a service facility designated by Panduit Corporation. Buyer shall prepay all the shipping charges to Panduit Corporation and if, in the opinion of Panduit Corporation, the product is defective, Panduit Corporation shall pay shipping charges to return the product to Buyer. However, Buyer shall pay all shipping charges, duties and taxes for products returned to Panduit Corporation from another country.

The products presented in this User Guide are not designed, intended, authorized or warranted to be suitable for use as components in systems used in any life support or critical applications, including but not limited to, any applications intended to support or sustain life, any medical applications, any systems used for commercial transportation or nuclear facilities or any other applications where product failure could lead to personal injury, death or catastrophic property damage. Accordingly, Panduit Corporation disclaims any and all liability arising out of the use of the products in any life support or critical application. If buyer uses the product in any life support or critical application, buyer, and not Panduit Corp, assumes full responsibility for such use. Further, Panduit Corporation reserves the right to refuse to service any product used in any life support or critical application, and disclaims any and all liability arising out of Panduit's service or refusal to service such product.

The foregoing warranty shall not apply to defects resulting from, buyer-supplied firmware or unauthorized interfacing, modification or misuse of the product, operation outside of the environmental specifications for the product, or improper or inadequate site preparation or maintenance by Buyer.

NO OTHER WARRANTY IS EXPRESSED OR IMPLIED. PANDUIT CORPORATION SPECIFICALLY DISCLAIMS THE IMPLIED WARRANTIES OF MERCHANTABILITY AND FITNESS FOR A PARTICULAR PURPOSE.

THE REMEDIES PROVIDED HEREIN ARE BUYER'S SOLE AND EXCLUSIVE REMEDIES. Panduit CORPORATION SHALL NOT BE LIABLE FOR ANY DIRECT, INDIRECT, SPECIAL, INCIDENTAL OR CONSEQUENTIAL DAMAGES, WHETHER BASED ON CONTRACT, TORT OR OTHER LEGAL THEORY.

Unless otherwise specified by Panduit Corporation, opening of this product by unauthorized personnel will void this warranty.

Maintenance Agreement

Panduit also offers a separate Maintenance Agreement, which includes additional benefits and features. Contact your Panduit sales representative for details.

Trademarks

PanView iQ™, PViQ™, and PIM™ are trademarks of Panduit Corporation. All other trademarks are the property of their respective owners.

Table of Contents

SAFETY WARNING.....	3
WARRANTY	3
Maintenance Agreement.....	4
Trademarks.....	4
Important Information.....	8
General Safety Notices.....	8
Purpose.....	9
How to Use This Document	9
Audience	9
Contacting Panduit.....	9
Conventions Used in This Document	10
Acronyms	10
System Overview	11
Introduction to the PViQ Hardware	11
PViQ Hardware Components	11
Components and Functionality	12
Patch Panels.....	12
Fiber Trays.....	13
Intelligent Modules.....	13
Mounting Brackets	15
Fiber Tray Mounting Bracket.....	16
Patch Cords and Cables.....	16
Power Supply	18
PViQ System Hardware Installation Overview.....	19
Panel Mounting and Grounding.....	19
Jack Module Installation.....	21
Installing the Interface Units.....	21
Installing the Mounting Brackets.....	22
Installing the Intelligent Modules.....	24
Module Installation	24
PM and EM Connections	25
Connection Points.....	25
Connecting the PM to the EM	26
Daisy Chaining EMS.....	26
Connecting Multiple PMs	26
Connection Diagram	27
Attaching the Power Supply.....	28
Labels and Label Cover Installation.....	29
Initial Power Up	30
Interacting with PViQ Hardware	31
PViQ Interface Unit Overview	32
Interface Unit (IU) Function Keys.....	32
Identifying the Function Keys.....	32
Understanding Modes.....	33
Secure Mode.....	34
Identifying Secure Mode	34
Entering Secure Mode from the UI	34
Secure Violations	34
Trace Mode	36
Identifying Trace Mode	36

Entering Trace Mode	36
Trace Mode Functionality.....	37
Exiting Trace Mode	37
MAC Mode	38
Identifying MAC Mode.....	38
Entering MAC Mode.....	38
Exiting MAC Mode	38
Learn Mode.....	38
Identifying Learn Mode	38
Entering Learn Mode	39
Exiting Learn Mode	39
Maintenance Mode.....	40
Identifying Maintenance Mode.....	40
Entering Maintenance Mode.....	40
Performing a Maintenance Mode Reset	42
To perform a Maintenance Mode Reset:	42
Exiting Maintenance Mode.....	43
Location Mode.....	44
Identifying Location Mode	44
Entering Location Mode.....	44
Exiting Location Mode.....	44
Mode Identification Summary.....	45
Understanding Port LED Indicators	46
Introduction	48
Cross-Connect	48
Cross-Connect Data Center Solution	48
Cross-Connect Enterprise Solution	49
Interconnect	50
Interconnect Data Center Solution.....	50
Interconnect Enterprise Solution.....	51
PViQ Interconnect Patch Cords.....	52
Introduction	52
PIM Switch Support	52
PViQ Basic Interconnect Patch Cord.....	52
Enhanced PViQ Interconnect Patch Cord	53
PViQ Fiber Interconnect Patch Cord	53
Making Connections using PViQ I-Cords	54
Introduction	54
Basic I-Cord Connection	54
Basic I-Cord Connection – Incorrect Switch Port.....	56
Enhanced I-Cord Connection	58
Enhanced I-Cord Connection – Incorrect Switch Port	60
Fiber I-Cord Connection	62
Fiber I-Cord Disconnection.....	63
Fiber I-Cord Guided Patching	64
PViQ Command Line Interface (CLI)	65
Introduction	65
Using the CLI	65
Finding the IP Address of the Panel Manager	65
To Telnet into the Panel Manager	67
CLI Commands.....	68
Output Examples of Common CLI Commands	75

To display the current configuration parameters 75
To display and change the current modes of the panels..... 75
To display the current Firmware Revision 76
To display Port information for a given panel 76

Important Information

General Safety Notices

Review the following safety precautions to avoid injury and prevent damage to this product or any products connected to it.

Only qualified personnel should perform service procedures

Injury Precautions

Use Proper Power Cord with Panduit Adapter. To avoid fire hazard, use only the power cord specified for this product.

Avoid Electric Overload. To avoid injury or fire hazard, do not apply potential to any input, including the common inputs that vary from ground by more than the maximum rating for that input.

Do Not Operate Without Covers. To avoid electric shock or fire hazard, do not operate this product with covers or panels removed.

Do Not Operate in Wet/Damp Conditions. To avoid electric shock, do not operate this product in wet or damp conditions.

Do Not Operate in an Explosive Atmosphere. To avoid injury or fire hazard, do not operate this product in an explosive atmosphere.



Product Damage Precautions

Use proper Power Source. Do not operate this product from a power source that applies more than the voltage specified.



Do Not Operate With Suspected Failures. If you suspect there is damage to this product, have it inspected by qualified service personnel.

Safety Terms and Symbols

The following terms appear in this manual:

	WARNING. Warning statements identify conditions or practices that could result in injury or loss of life.
	CAUTION. Caution statements identify conditions or practices that could result in damage to this product or other property.

Symbols on the Product

	Protective Ground (Earth) Terminal
	ATTENTION – Refer to Manual

About This Document

Purpose

The Panduit® PanView iQ™ (PViQ™) Hardware User Manual is designed to enable end-users to:

- Understand the components and functionality of the PViQ Hardware
- Perform the initial hardware installation of the PViQ System
- Perform standard operations for the PViQ System.

How to Use This Document

The Panduit PanView iQ (PViQ) Hardware User Manual consists of the following three sections:

1. System Overview
2. Installation and Power Up
3. Hardware Operation Overview

Use the System Overview section to understand the basic features of the PViQ System Hardware. The section includes descriptions of the individual components of the system and provides an overview of component functionality.

Use the Installation and Power Up section to perform component installation and setup, understand cable routing recommendations, and attach the appropriate power supplies.

Use the Hardware Operation Overview section to understand and use the different modes of the PViQ Interface Unit. The section also includes information on the PViQ Command Line Interface (CLI) which allows access to PViQ commands through a Telnet interface.

Audience



The PViQ Hardware User Manual is intended for network personnel and users whose roles require the installation, configuration or operation of PViQ hardware.

Contacting Panduit

For Technical Support on PViQ Hardware, please contact Panduit Technical Support using one of the following methods:

- Toll-Free: 1-866-721-5302, Monday-Friday, 24 hrs/day
- 24/7 phone support - Response typically within the hour on weekends
- Email: systemsupport@panduit.com

Conventions Used in This Document

Convention	Type of Information
 Note	Indicates additional, supporting information.
 CAUTION	Indicates that an action may be service affecting.
Chapter and section “titles.”	References to chapter and sections names also appear in quotes (e.g., refer to the chapter titled, “About This Document.”)

Acronyms

Acronym	Meaning
API	Application Programming Interface
CLI	Command Line Interface
DPoE™	Data and Power over Ethernet products
DHCP	Dynamic Host Configuration Protocol
EM	Expansion Module
EPC	Expansion Port Cable
GUI	Graphical User Interface
HTTP	Hypertext Transfer Protocol
HTTPS	Hypertext Transfer Protocol Secured
I-Cord	PViQ Interconnect Patch Cord
IM	Intelligent Module
IU	Interface Unit
LAN	Local Area Network
MAC	Moves, Adds, and Changes
MAC address	Media Access Control Address
MTP	Media Termination Point
PD	Powered Device

PIM	Physical Infrastructure Manager
PM	Panel Manager
PPP	Powered Patch Panel
PViQ	PanView iQ
RU	Rack Unit
SNMP	Simple Network Management Protocol
STP	Shielded Twisted Pair
UTP	Unshielded Twisted Pair

System Overview

Introduction to the PViQ Hardware

The PViQ System Hardware uses intelligent modules that connect directly into the back of PViQ™ Patch Panels, eliminating the need for additional hardware components that consume rack space.

PViQ Hardware Components

The basic hardware components of the system include:

- PViQ Patch Panel
 - Angled or flat
 - Shielded or unshielded
- PViQ Fiber Trays
 - MTP Single Mode connections
 - MTP Multi-Mode connections
 - Field Terminated connections
- PViQ Intelligent Modules
 - Panel Manager (PM)
 - Expansion Module (EM)
- PViQ Interface Units
- Mini-Com® Jack Module / Fiber Adapter
- Mounting Brackets
- PViQ Patch Cords
- Expansion Port Cable (EPC)
- Labels and Label Covers
- Power Supply

Components and Functionality

Patch Panels

PViQ Patch Panels are available in several styles:

- 24-port, flat (shielded or unshielded)
- 24-port, angled (shielded or unshielded)

Figure 1 shows the flat panel. This patch panel is available in both shielded and unshielded versions, and is compatible with UTP or STP Mini-Com Copper Modules.



Figure 1 - Flat PViQ Patch Panel

Figure 2 shows the angled panel version. This patch panel is available in both shielded and unshielded versions, and is compatible with UTP or STP Mini-Com Copper Modules.



Figure 2 - Angled PViQ Patch Panel

Fiber Trays

PViQ supports patching capabilities through fiber channels with the use of fiber trays. Fiber tray supports:

- LC to MTP Single Mode connections
- LC to MTP Multi-Mode connections
- Field Terminated connections



Figure 3 - PViQ Fiber Tray

Intelligent Modules

The PViQ System Hardware includes two types of Intelligent Modules (IMs):

- Panel Managers (PMs)
- Expansion Modules (EMs)

The Panel Manager (PM) is a removable module that provides scanning and management capabilities for patch panels or fiber trays.



Figure 4 - PViQ Panel Manager

The PM includes LAN connectors for daisy chaining multiple PMs. A total of 30 PMs may be daisy chained to access the network via a single LAN port. An expansion port extends management capabilities and power from the PM to 1, 2, or 3 EMs.

- ✓ The back of PM has a label showing the MAC Address of the unit. Make a note of the MAC Address or Bar Code Scanner – it is needed for a later step in the installation.

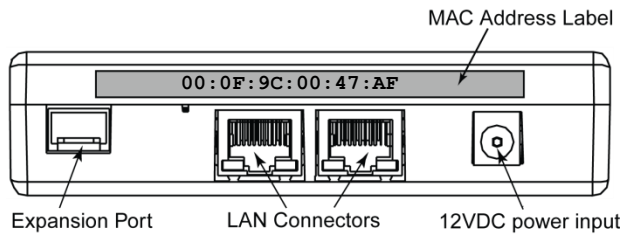

Figure 5 – PM Connections

The Expansion Module (EM) expands the scanning and management capabilities of the PM by providing access to additional patch panels.



Figure 6 - PViQ Expansion Module

Each PM may control up to three EMs, expanding the PM’s scanning and management capability to a maximum of four patch panels.

✓ **NOTE:** PViQ panels cannot be shipped with the PM, EM, or Fiber Trays installed. Shipping in this scenario may cause the wing board connector electrical failure.

Interface Units

The PViQ Interface Unit (IU) attaches to the front of the patch panel or fiber tray, and provides access to various operational modes directly from the front of the panel. There are two styles of IU that can be attached to the patch panel. The figures below show the IU for the Panel Manager and the IU for the Expansion Module.



Each IU has four LED indicators, plus two navigation keys. In addition, the PM IU includes a Provisioning Port that supports Basic and Enhanced I-Cords.

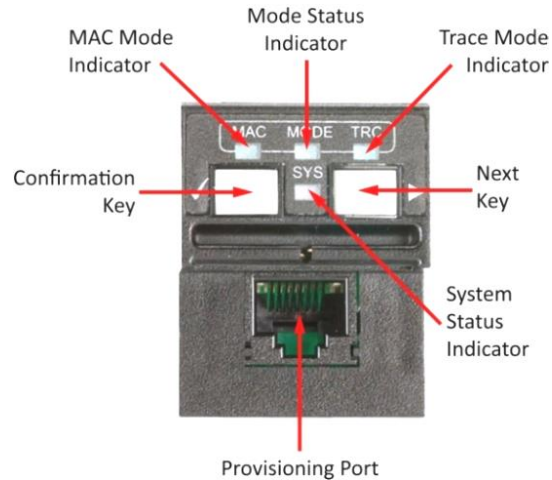

Figure 9 - PViQ Panel Manager Interface Unit, showing the Provisioning Port (PM IU only)

Mounting Brackets

Panel Managers and Expansion Modules are connected to the patch panel using specific PViQ Mounting Brackets. See the following figure for an example of the mounting bracket.



Figure 10 - Panel Manager and Expansion Module Mounting Bracket

Both the PM and EM use the same style of mounting bracket. Mounting brackets, including a built-in securing screw, are included with each PM or EM.

Fiber Tray Mounting Bracket

PViQ Fiber Trays do not require separate mounting brackets. The Expansion Modules plug directly into the tray via the built-in mounting bracket, as shown below.

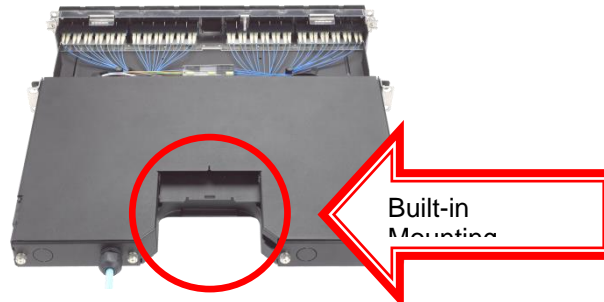

Figure 11 - Fiber Tray Mounting Bracket

Patch Cords and Cables

Within the PViQ System, specific patch cords and cables are required for the following connections:

1. To connect the PM to the EM, use a PViQ Expansion Port Cable (supplied with the EM – see below)



Figure 12 - PViQ Expansion Port Cable

2. To connect one PM to another PM, use a standard shielded RJ45 patch cord (supplied with the PM). If you choose to use patch cord other than the supplied cord, it must be a **shielded** RJ45 patch cord.
3. To connect the PViQ Patch Panel ports to switches and other PViQ Patch Panels, use:
 - a. PViQ Patch Cords
 - b. PViQ Interconnect Patch Cords
 - c. PViQ Enhanced Interconnect Patch Cords
4. To connect two PViQ Patch Panel ports, use:
 - a. A shielded cross-connect cord
 - b. An unshielded cross-connect cord
 - c. An MTP single-mode or multi-mode fiber cross-connect cord
5. To connect a PViQ Patch Panel port to a switch or other non-PViQ port, use:
 - a. An interconnect cord (I-Cord)
 - b. An enhanced, shielded I-Cord

- c. An enhanced, unshielded I-Cord
- 6. To connect a PViQ Fiber Patch Panel port to a switch or other non-PViQ port, use:
 - a. A Fiber Interconnect cord (Fiber I-Cord)

The following three figures show the different styles of patch cords used with PViQ Patch Panels.

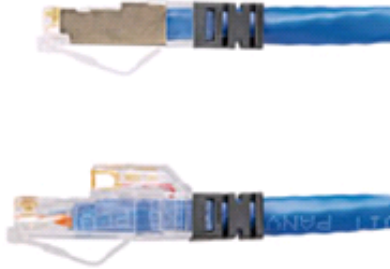

Figure 13 - PViQ Interconnect Patch Cord

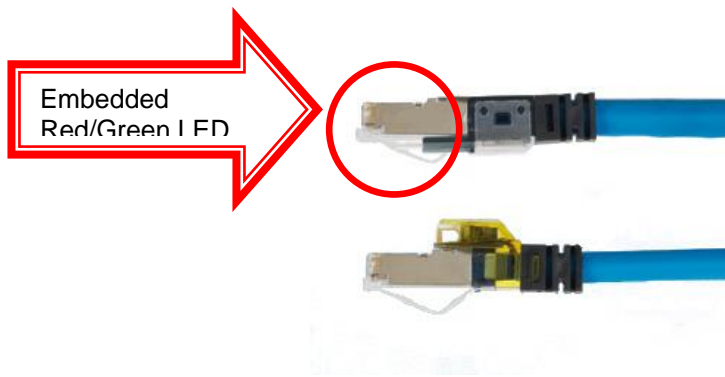

Figure 14 - PViQ Enhanced Interconnect Patch Cord



Figure 15 - PViQ Fiber Interconnect Patch Cord

Power Supply

The PViQ System uses one 12-volt power supply per “cluster” (one PM and three EMs).



Figure 16 - Power Supply

Before applying power to the unit, ensure that you have an appropriate power supply for your region. Use the Panduit power supply identified in the table below, or a recommended end use LPS power supply where applicable.

Table 1 - Power Supply Part Numbers

Region	Part Number
North America	PVQ-PS12VDC-S
Europe	PVQ-PS12VDC-E
United Kingdom	PVQ-PS12VDC-U
Japan	PVQ-PS12VDC-J
China	PVQ-PS12VDC-C

Installation and Power Up

PViQ System Hardware Installation Overview

This section describes the steps and procedures for installing and powering your PViQ System Hardware. You may also refer to the installation instructions that were included with your hardware packaging.

This section presents the installation steps for each of the components that make up the standard PViQ cluster, including:

- Four (4) Patch Panels (shielded or unshielded, flat or angled) or Fiber Trays
- 96 Terminated Jack Modules (24 per panel, four panels) if applicable (sold separately)
- Interface Units
 - One (1) Panel Manager Interface Unit
 - Three (3) Expansion Module Interface Units
- Four Mounting Brackets (not required for fiber trays)
- Intelligent Modules
 - One (1) Panel Manager
 - Three (3) Expansion Modules
- Connections
 - One (1) shielded RJ45 LAN cord
 - Three (3) Expansion Port Cables
- Ultimate ID Labels (sold separately) and Ultimate ID Label Covers
- One (1) LPS Power Supply (sold separately)

Panel Mounting and Grounding

The first step in the PViQ Hardware installation procedure is to connect the patch panels or fiber trays to the rack. Typically, this would include four 24-port panels – one for the Panel Manager (PM) and three for the Expansion Modules (EMs).

PViQ Patch Panels and Fiber Trays work interchangeably with either the PM or the EM. It is recommended that they be placed in a manner that will efficiently accommodate one PM for every three EMs, with appropriate cable management installed for proper cable routing. The PM can be placed at either the top or bottom of the cluster, depending on need or preference.

✓ The Expansion Modules (EMs) are connected using an Expansion Port Cable (EPC). The EPC should be carefully installed so that the connectors on both ends are not bent or stretched in a manner to stress the connection points.

The following figure shows one suggested panel layout with the PM taking the top position of the cluster. Other layouts are also possible.

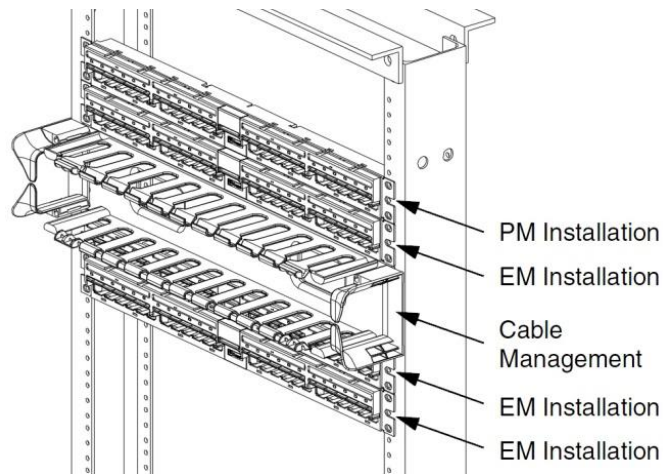

Figure 17 - Suggested Panel Layout, with 2RU Cable Management

Mount the PViQ Patch Panel onto the face of the rack or rack cabinet using the supplied grounding screws (as shown below)

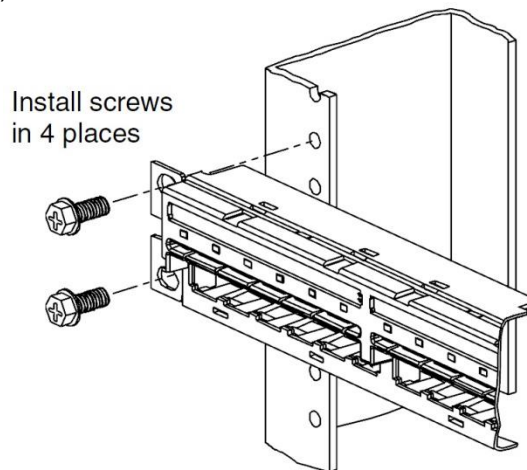



Figure 18 - Panel Installation

✓ PViQ Patch Panels **MUST** be properly grounded to ensure accurate system operation.

After the grounding screws have been properly secured, repeat the process for the remaining panels.



Warning If supplied screws do not fit or work with your rack or rack cabinet to provide appropriate grounding, the following screws are recommended:

- Thread Forming Screw, M5 x 12mm (Part # RGTSM5-C)
- Thread Forming Screw, #10-32 x 1/2" (Part # RGTS1032-C)

Jack Module Installation

With the PViQ Patch Panel secured to the rack or cabinet, the next step is to install terminated jack modules into the patch panel. In a standard cluster configuration (one PM connected to three EMs), 96 jacks are needed, although PViQ does not require a jack in every port.

If sufficient slack cable is available, the terminated Mini-Com Jack Modules can be installed into the PViQ Patch Panel prior to permanently mounting into the rack. This will allow for flexibility and provide easier access to the panels.

✓ The PViQ Patch Panel accepts all Mini-Com Copper Jack Modules.

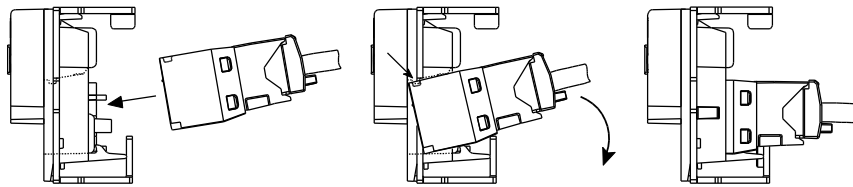

Figure 19 - Side View of Jack Installation

Installing the Interface Units

The next step is to install the Interface Units (IUs) on the individual panels. The IUs attach to the front of the flat or angled patch panels, and provide access to various operational modes.

PViQ Patch Panels are shipped from the factory with a *blank* Interface Unit which must be removed prior to installing the actual IU.

To remove the blank plastic interface unit, depress the locking tabs from the rear of the panel (upper right and lower left) and gently push the unit forward (see below).

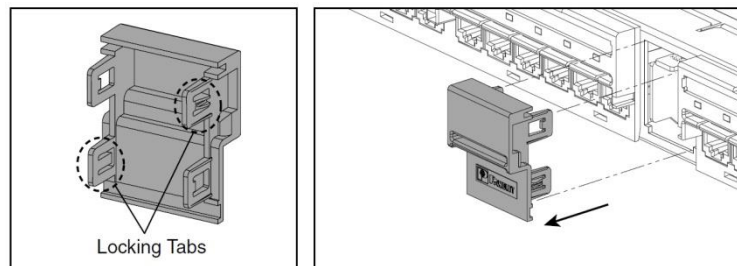

Figure 20 – Remove the Blank IU

The new PM or EM Interface Unit can now be installed by gently pushing it into the open slot until it snaps into place (see below). Ensure that the Interface Unit is mounted with the LED indicators on the top.

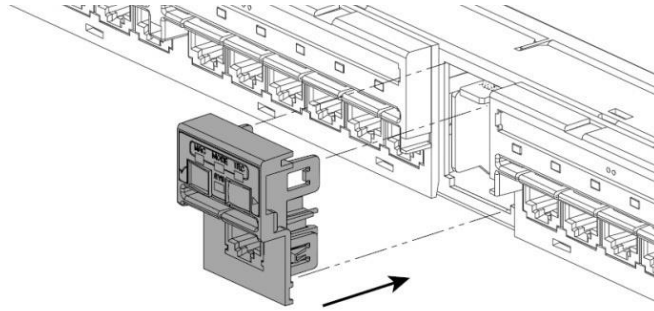

Figure 21 - Install the proper IU

It is important to install the correct Interface Unit on the correct patch panel. The Patch Panel that houses the Panel Manager requires an IU with an RJ45 interface jack (provisioning port) located on it. The panels for the Expansion Modules will receive IUs that *do not* have this Provisioning Port. Refer to the following figures to see the differences.

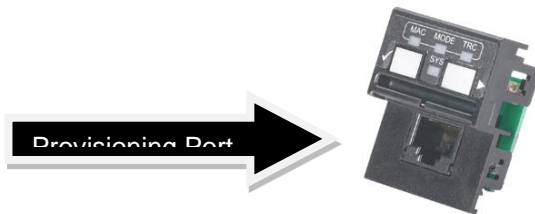

Figure 22 - Panel Manager Interface Unit with Provisioning Port (RJ45)



Figure 23 - Expansion Module Interface Unit

Installing the Mounting Brackets

The Panel Manager and Expansion Module(s) attach to the back of the Patch Panels using a Mounting Bracket. Both the PM and EM use the same Mounting Bracket.

✓ Fiber Trays do not require Mounting Brackets.

1. Locate the mounting bracket on the center of the PViQ Patch Panel.

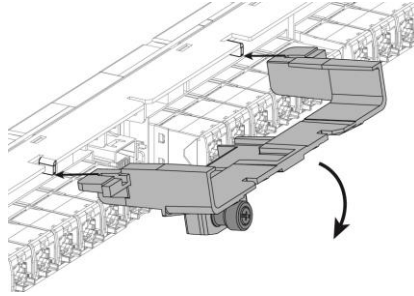

Figure 24 - Mounting Bracket, step 1

2. Pivot bracket until the tabs on the patch panel rest inside the slots of the mounting bracket.

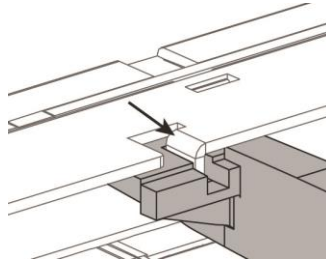

Figure 25 - Mounting Bracket, step 2

Apply forward and upward pressure until the bracket slides into the catch on the patch panel.

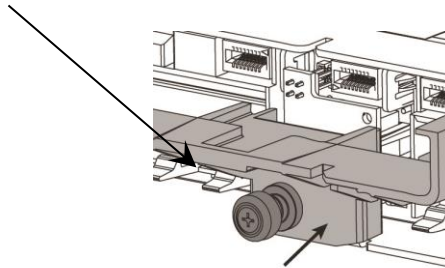

Figure 26 - Mounting Bracket, step 3

Secure the bracket to the patch panel using a Phillips-head screwdriver to push in and turn the securing screw.

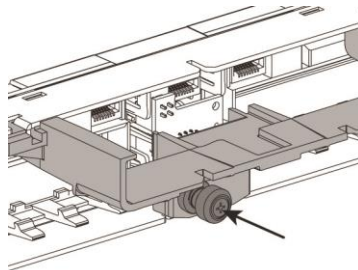

Figure 27 - Mounting Bracket, step 4

Installing the Intelligent Modules

With the mounting brackets securely in place, the next step is to install the Intelligent Modules:

- Panel Manager (PM)
- Expansion Module(s) (EMs)

The installation procedure is the same for both the PM and the EM; however *the PM must be installed in the patch panel or fiber tray containing the Panel Manager Interface Unit*. The PM Interface Unit can be identified by the Provisioning Port – the RJ45 jack on the front of the unit.

✓ **NOTE:** PViQ panels cannot be shipped with the PM, EM, or Fiber Trays installed. Shipping in this scenario may cause the wing board connector electrical failure.

Module Installation

Slide the PM or EM into the mounting bracket as shown below.

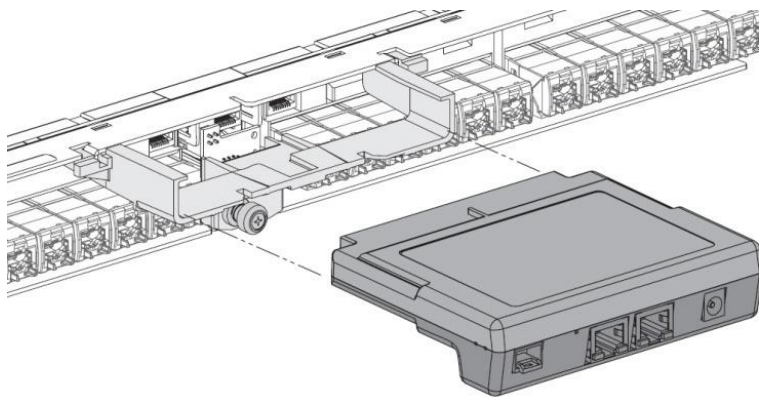

Figure 28 - Insert Module into Bracket

The latch on the bottom of the PM or EM will snap into the slot on the bracket, and an audible “click” should be heard.

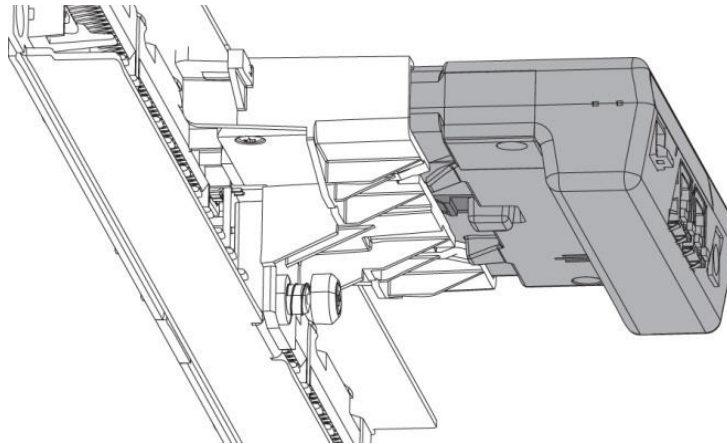

Figure 29 - Connecting the Bottom Latch

Repeat the process for each of the modules, ensuring that each is firmly locked into place before proceeding.

PM and EM Connections

This section describes the process for making the following connections:

- Connect the PM to the network
- Connect the PM with an EM
- Daisy chain multiple EMs
- Connect multiple PMs together

Connection Points

Panel Manager connections are made from the back of the unit. The figure below shows the connection points.

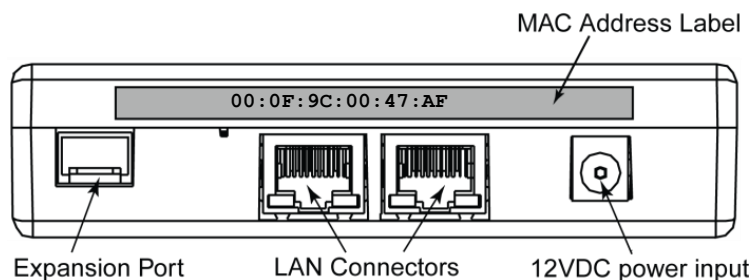

Figure 30 - Panel Manager Connections

The Expansion Port is used to connect the PM to an EM through the supplied Expansion Port Cable (EPC).

The LAN connectors are used to connect the PM to the network, or daisy chain multiple PMs. The LAN ports are interchangeable; either port may be used for the network or the daisy chain. Up to 30 PMs may be daisy chained together.

A 12VDC power input (sold separately) must be connected to the 12VDC power input on the back of each PM. Power from the PM is then distributed to the EMs via the EPC.

The Media Access Control (MAC) address label is a printed sticker found on the back of the PM. This MAC Address uniquely identifies the PM to your network. Make note of this MAC Address and refer to it when provisioning the rack location into the PM.

The connection points for the EM are shown below.

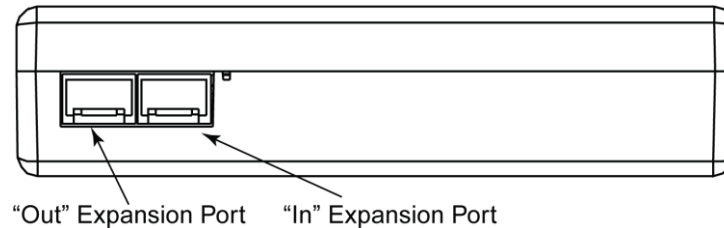

Figure 31 - Expansion Module Connectors

The "Out" Expansion Port connects the EM to the next EM in the chain. Up to 3 EMs may be daisy chained to a single PM.

The "In" Expansion Port receives an EPC from either the PM or another EM.

Connecting the PM to the EM

Connect the PM to the first EM in the chain by attaching one end of the supplied Expansion Port Cable (EPC) to the "Out" Expansion Port on the PM. Then attach the far end of the EPC to the "In" Expansion Port of the first EM in the chain. The EPC will have a positive latch when inserting into the Expansion Ports. To remove the EPC, depress the locking tab on the EPC before removing it from the Expansion Port.

- ✓ Ensure that the EPC is not bent or stretched to the point of stress.

Daisy Chaining EMs

To connect one EM to the next EM in the chain, attach one end of the supplied EPC to the "Out" Expansion Port on the EM. Then attach the far end of the EPC to the "In" Expansion Port of the next EM in the chain (see below).

Up to 3 EMs may be daisy chained to a single PM.

- ✓ Ensure that the EPC is not stretched or stressed in any way, especially when using cable managers.

Connecting Multiple PMs

Multiple PMs can be daisy chained together, providing management access of additional panels through a single LAN connection. Using this method, up to 30 PMs can be controlled by a single LAN port.

Begin by attaching the shielded RJ45 cable (supplied) to either of the LAN connectors on the back of the PM. Then, attach the far end of the cable to either of the LAN connectors on the next PM in the chain. Repeat this procedure for as many PMs as required (up to 30).

- ✓ Although both LAN connectors can function as either an “In” or an “Out” connection, you may want to establish a standard convention for easier traceability. For example, use the right connector as the “In” connection and the left connector as the “Out” connection.
- ✓ **CAUTION:** In order to avoid a “looping” error condition, ensure that the last PM in the chain has one Ethernet port unconnected.

Connection Diagram

The figure below shows all of the connections described in this section. Table 2 defines each of the connections.

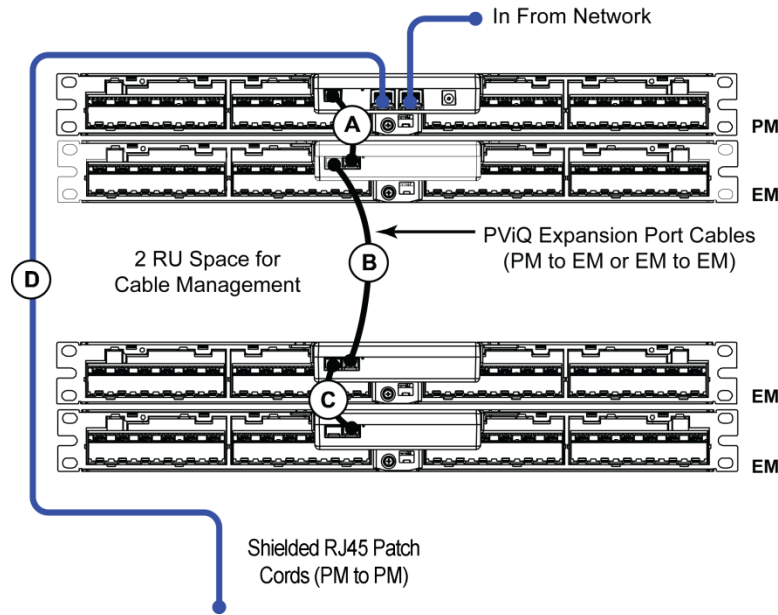

Figure 32 - Connection Diagram

Table 2 - Connection Types

Label	Connection
A	PM Expansion Port out to EM Expansion Port in
B	EM Expansion Port out to EM Expansion Port in
C	Connection B repeated for an additional EM

D

PM LAN out to PM LAN in

Attaching the Power Supply

The PViQ Power Supply provides power to an entire PM Cluster (one PM module and up to three EM modules) through the PM module.

Attach the appropriate end of the AC cord to the Power Supply. Insert the Power Supply's angled plug into the PM (see Figure 33).

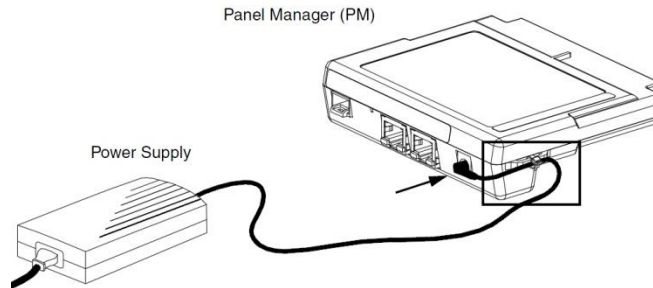

Figure 33 - Power Supply

Secure the power cable to the PM strain relief with a Pan-Ty cable tie (available separately), as shown below (a larger view of the boxed area in Figure 34).

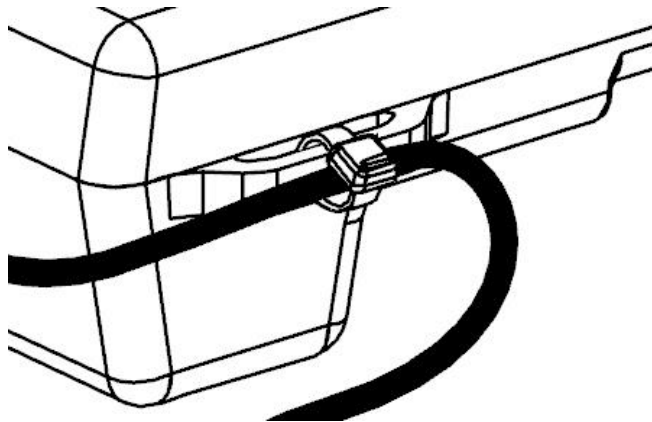

Figure 34 - Strain Relief, Expanded View

✓ For Fiber Trays, strain relief is integrated directly into tray itself. If you are using Fiber Trays, you will **not** use the strain relief on the PM.

Before applying power to the unit, ensure that you have the correct power supply for your region as shown in Table 3.

Table 3 - Power Supply Part Numbers

Region	Part Number
--------	-------------

North America	PVQ-PS12VDC-S
Europe	PVQ-PS12VDC-E
United Kingdom	PVQ-PS12VDC-U
Japan	PVQ-PS12VDC-J
China	PVQ-PS12VDC-C

Labels and Label Cover Installation

PViQ Patch Panels must be labeled according to TIA/EIA-606-A standards. To meet this requirement, the Ultimate ID™ Network Labeling System (not included) can be used to create labels (see Figure 35).

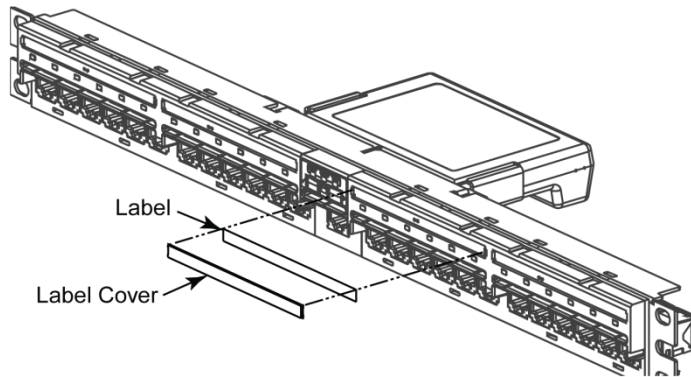

Figure 35 - Installing Ultimate ID Labels and Ultimate ID Label Covers

Ultimate ID Labels are sized to cover 6 ports, four per panel. Ultimate ID Label covers should be installed to protect the label. Four label covers are included with each PViQ Patch Panel.

- ✓ Write-on labels are not included with this patch panel per TIA-EIA-606-A standard which states: “To maximize legibility, all labels shall be printed or generated by a mechanical device, and shall not be written by hand.”

Initial Power Up

When power is first applied to the PViQ Hardware, a series of diagnostics and firmware updates take place. These updates are automatic and occur without any intervention from the user.

From the user point of view, you will see port LEDs lighting and extinguishing in a series as the PM synchronizes the firmware revisions of each piece of hardware. When all of the port LEDs are extinguished, and the System Status (SYS) LED on each Interface Unit (IU) is solid green, the panel is in "Secure" mode and ready for operation.

- ✓ If any cables are connected to a port, a RED LED may be lit above that port. See the section on **Secure Violations** on page 34 for more information.

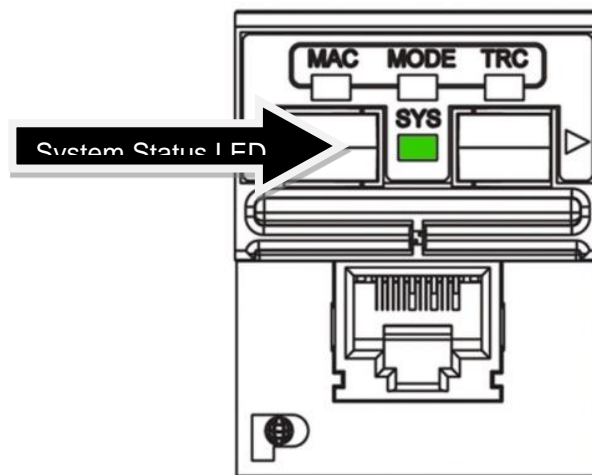

Figure 36 - Secure Mode Indicator

NOTE: The entire initialization process may take up to 45 minutes to complete for a complete cluster (one PM and three EMs). Please be patient during this time and do not take any further action until Secure Mode status is reached.

Interacting with PViQ Hardware

There are several ways to interact with the PViQ System Hardware:

- Through the Panel Manager (PM) or Expansion Module (EM) Interface Units (IUs)
- Through the Pan Shell Command Line Interface (CLI) initiated using Telnet
- Through Panduit's Physical Infrastructure Manager (PIM) Software (available separately, see note below).

For details on using the IUs, refer to the section titled "**PViQ Interface Unit**" later in this document.

For details on using the CLI, refer to the tab titled "**PViQ Command Line Interface**" later in this document.

For details on using the PIM Software Platform, refer to **PIM Software User Manual**, which is included as part of the documentation set of the PIM Software Platform.

- ✓ The Physical Infrastructure Management™ (PIM™) Software Platform is a Windows based Graphical User Interface (GUI) that can be purchased separately from Panduit.

PViQ Interface Unit

PViQ *Interface Unit Overview*

The PViQ System Hardware has several standard operating modes. These various modes are accessed through unique combinations of key presses using the Function Keys (the Confirmation Key and Next Key), or through the PIM Software. The remainder of this section will describe how to identify and use each mode.

Interface Unit (IU) Function Keys

Once the PViQ System Hardware components have been installed and powered up, the system will eventually enter the Secure Mode state. At that point, one way to interact with the panel itself is through the use of the Interface Unit (IU) Function Keys, located on the front of the IU.

This section describes how the function keys work, and some of the general tasks that can be accomplished.

Identifying the Function Keys

The IU has two Function Keys, located on the front of each Interface Unit.

- The Left Function Key is called the “Confirmation” Key. It is identified by the small checkmark to the left of the key.
- The Right Function Key is called the “Next” Key. It is identified by the arrow to the right of the key.

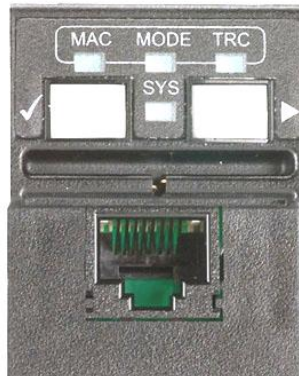

Figure 37 - IU Function Keys

Pressing the Function Keys in predefined sequences enables users to initiate different operating modes.

Understanding Modes

The functionality of the PViQ System Hardware is determined by its mode of operation. There are six basic modes of operation, and each has its own uses and functionality.

It is important to be able to visually determine the current state of the hardware, and to manipulate the hardware into the desired mode, to accomplish various tasks.

PViQ System Hardware Modes include:

- Secure Mode
- Trace Mode
- MAC Mode
- Learn Mode
- Maintenance Mode
- Location Mode

These modes are defined in the following table. Detailed information can be found in later sections.

Table 4 - Mode Definitions

Mode	Meaning
Secure Mode	Secure Mode is the normal operating state. Provides visual alerts when any unauthorized changes are made. The panels will automatically enter Secure Mode unless specifically placed into other modes.
Trace Mode	Trace Mode visually identifies or verifies near-end and far-end connectivity in a patch panel or fiber tray.
MAC Mode	Move, Add, and Change (MAC) Mode notifies users when pending change orders have been sent to the PViQ Patch Panel. MAC Mode can only be entered using the PIM Software Interface.
Learn Mode	Learn Mode is a process where panel and port information for existing patch connections is detected and learned. Learn Mode can be entered using either the PIM Software or the Command Line Interface. For security reasons, panels cannot be placed into Learn Mode via the front panel.
Maintenance Mode	Maintenance Mode is used for resets, restorations and firmware updates.
Location Mode	Location Mode is used to identify where a specific panel resides within a facility. When invoked, all of the port LEDs for the requested panel light green, and the panel beeps until the Confirmation Key on the Interface Unit is pressed. Location Mode is entered via the PViQ Command Line Interface.

Secure Mode

Secure Mode is the normal operating mode. Each patch panel will be in Secure Mode under normal operating conditions.

Once a panel is in Secure Mode, any unauthorized changes that occur in the patch field will result in a “Secure Violation,” and a red LED will light above the port identifying the violation. The LED will remain red until the violation has been cleared (see **Secure Violations**, later in this section).

Identifying Secure Mode

In Secure Mode, the System Status Indicator LED (SYS) remains solid green. All other indicator LEDs are off. Figure 38 - Secure Mode shows the IU in Secure Mode.

- ✓ The SYS LED for the PM will briefly flash amber every 10 seconds.

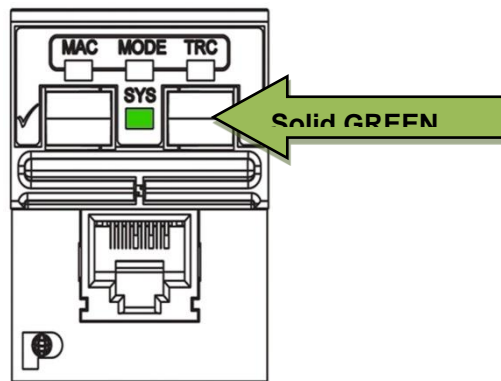

Figure 38 - Secure Mode

Entering Secure Mode from the UI

Secure Mode is the default mode after initial power up. It is also the mode to which the system typically returns after resets, and following the completion of activities initiated by other modes.

Secure Mode can be accessed through:

- Interface Unit (IU) Function Keys
- Command Line Interface (CLI)
- PIM™ software

Secure Violations

All changes made to the patch field should be initiated through the PIM software. If a change is made without a request from the PIM software (i.e., manually connecting or disconnecting patch cords at either end of the cord), a Secure violation occurs.

- ✓ When PViQ Patch Panels are first powered up, existing patch cord connections will all appear as Secure violations until Learn Mode is initiated. This is normal.

Inserting a patch cord, or removing a patch cord, causes the LED above the port associated with the violation to light solid red.



Figure 39 - Secure Violation

Removing one end of a patch cord will also cause the far end LED to light solid red, indicating that it is also affected by the action. Restoring the connections to their original state extinguishes the LEDs. If the cords are installed in the wrong positions, the ports will remain in Secure Violation.

Trace Mode

Trace Mode is used for the direct mapping and verification of end-to-end patch field connection points.

Identifying Trace Mode

In Trace Mode, the System Status Indicator LED (SYS) and Trace Indicator LED (TRC) light solid green. All other indicator LEDs are off. Figure 40 shows the IU in Trace Mode.

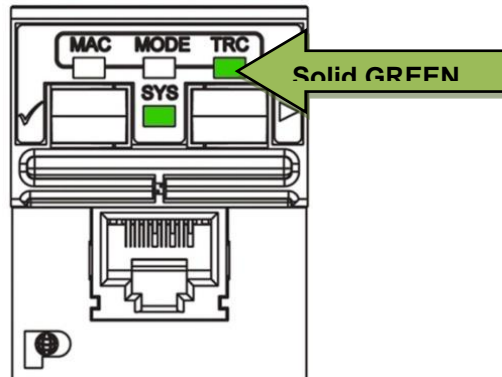

Figure 40 - Trace Mode

Entering Trace Mode

To enter Trace Mode:

1. Press and hold the left Function Key of the IU for approximately 2 seconds. When the TRC indicator flashes green and an audible tone is heard, release the key.
2. Confirm trace mode by pressing and releasing the left Function Key a second time. TRC indicator will change to solid green and an audible acknowledgement beep will sound.

✓ Step 2, above, must be completed within five seconds of step 1, or Trace Mode will be exited automatically.

In Trace Mode, the System Status Indicator LED (SYS) and Trace Indicator LED (TRC) light solid green. All other indicator LEDs are off. Figure 41 - IU Trace Mode shows the IU in Trace Mode.

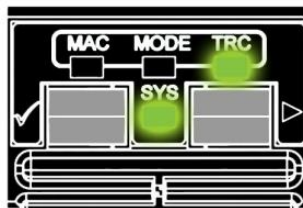

Figure 41 - IU Trace Mode

Trace Mode Functionality

Once the panel is in Trace Mode from the UI, Port 1 will begin to flash alternating green and red. Only one port on a panel can be traced at a time. To change ports, use the left and right Function keys on the IU to move left or right across the panel. Figure 42 below shows a patch panel in Trace Mode with Port 8 being traced.



Figure 42 - Patch Panel in Trace Mode

Once the desired port is selected, the PViQ Panel determines the corresponding far end port, and the corresponding port LED begins to flash alternating red and green.

If the far end port is located on a different patch panel, the far end panel will automatically enter Trace Mode, and the Trace Indicator LED will light solid green.

If an Enhanced I-Cord is being used, the LED connected to the traced port (the LED on the connector) will “triple flash” (flash, flash, flash, off, flash, flash, flash, off . . .). The Enhanced I-Cord will triple-flash RED for double-ended connections, and GREEN for single ended connections.

Exiting Trace Mode

To exit Trace Mode:

1. Press and hold the left Function Key of user interface for 2 seconds. The patch panel will return to Secure Mode (or, Learn Mode if the panel was in Learn Mode before the Trace).
2. If the port being traced was connected to another panel, the far end patch panel will exit Trace Mode automatically when the Trace ends.

Trace Mode is used for the direct mapping and verification of end-to-end patch field connection points.

MAC Mode

Work orders for Move, Add, or Change (MAC) activities initiated through PIM Software place the PViQ Patch Panels into MAC Mode. This provides a visual reference on the panel itself, and notifies the user that a change order is pending.

Identifying MAC Mode

In MAC Mode, the System Status Indicator LED (SYS) is solid green and MAC Indicator LED (MAC) is solid green. All other indicator LEDs are off. Figure 43 shows the IU in MAC Mode.

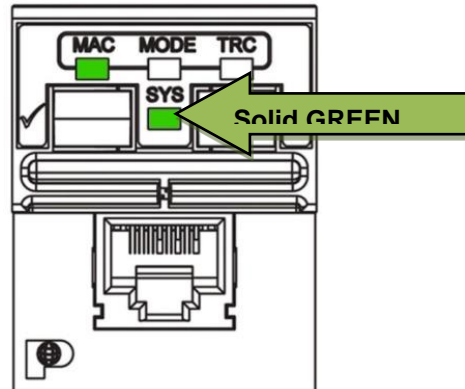

Figure 43 - IU MAC Mode

Entering MAC Mode

The PViQ Patch Panels can only be put into MAC Mode through the PIM software (available separately).

Exiting MAC Mode

Upon completion of the Move, Add, or Change activity, the PViQ Patch Panel will automatically return to Secure Mode.

Learn Mode

Learn Mode is used to commit the current patch field configuration to the database. Changes to the patch field (i.e., moving patch cables from one port to another) are “learned” by the PM, and saved to the PIM database. Learn Mode can be particularly valuable during first time setup, or when a large number of approved patch field modifications need to be completed.

Identifying Learn Mode

In Learn Mode, the System Status Indicator LED (SYS) will light solid green. The Mode Indicator LED (MODE) is amber. Figure 44 shows the PM IU in Learn Mode.

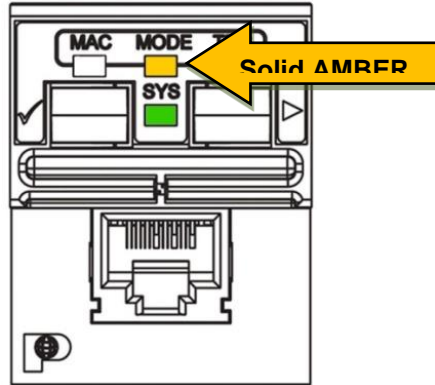

Figure 44 - Learn Mode

Entering Learn Mode

PViQ patch panels can be put in Learn Mode two ways:

- Using the CLI `set mode` command
- Using PIM™ Software Platform (available separately).

For security reasons, Learn Mode *cannot* be initiated through the Interface Unit (IU) Function Keys. To enter Learn Mode using the CLI `set mode` command, enter the command as shown below:

```
set mode <x> learn
```

Where <x> is the offset number of the panel.

Exiting Learn Mode

To exit Learn Mode, and return to Secure Mode, use the CLI `set mode` command, as shown below:

```
set mode <x> secure
```

Where <x> is the offset number of the panel.

Maintenance Mode

Maintenance Mode is used for initializing and resetting the PViQ Patch Panel.

This Mode provides the capabilities to perform panel reconfigurations, firmware updates, system level technical functions, and troubleshooting procedures.

CAUTION: This section describes actions that can cause the PViQ database to be cleared, losing all current configurations, provisioning and patch field connectivity data. Use caution before attempting Maintenance Mode Resets described here.

Identifying Maintenance Mode

In Maintenance Mode, the System Status Indicator LED (SYS), Trace Indicator LED (TRC) and MAC Indicator LED (MAC) will all light solid green. The Mode Indicator LED is off. Figure 45 shows the PM IU in Maintenance Mode.

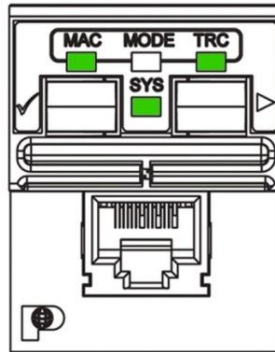

Figure 45 - PM IU in Maintenance Mode

In addition, all port LEDs will light solid red, and an audible beep will continue to sound every 15 seconds.

Entering Maintenance Mode

To Initialize Ports on the PViQ Patch Panel in Maintenance Mode:

1. Press and hold both Function Keys on the PM Interface Unit for about 5 seconds.

✓ Only the PM can initiate Maintenance Mode for a cluster. The EM cannot enter Maintenance Mode without the PM.

Result: The panel will beep once when the keys are initially pushed and again after 2 seconds. After 5 seconds, the Mode LED will blink green, indicating that the panel has recognized the request to enter Maintenance Mode.

If the "Mode" LED does not blink green after five seconds, check the following:

- Ensure the Interface Unit is for a PM and not an EM

- Ensure the unit is getting power
 - Ensure the PM module is fully inserted into the PViQ Patch Panel
2. Release both Function Keys simultaneously.

Result: The Mode LED will continue to flash for another 5 seconds, during which time the user can confirm or cancel the Maintenance Mode.

3. To **confirm**: press and release the left Confirmation Function Key. The confirmation is acknowledged with a beep.

To **cancel**: press and release the right Function Key, or let the panel simply time out after 5 seconds. The time out will be acknowledged by three short beeps.

After confirmation of Maintenance Mode, the PM and all connected EM Interface Unit Mode LEDs will turn off and the MAC and TRC (Trace) LEDs will turn on.

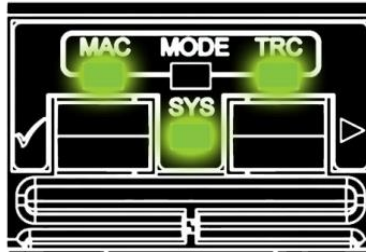

Figure 46 - Maintenance Mode

Additionally, all port LEDs will turn red.

The Maintenance Mode has a default 30 minutes time limit before it will exit. Five minutes before this time limit is reached the panel will begin producing 2 short beeps every 5 seconds, serving as a pre-timeout warning.

At any point after these warnings begin, the Maintenance Mode time can be extended for an additional 30 minutes by pressing and releasing the left Function Key, acknowledged by a beep to confirm the request.

- ✓ While in Maintenance Mode, the panel will produce a short beep every 15 seconds. By default the PM and all connected EM Interface Unit MAC, Trace, and Sys LEDs will turn green, and all port LEDs will turn red.

Performing a Maintenance Mode Reset

Eight levels of initialization and resets can be performed when the PM is in Maintenance Mode:

Level 1 – Reset the PViQ Patch Panel host processor (or exit maintenance mode)

Level 2 – Reset all non-host processors

Level 3 – Performs Level 1 and Level 2 resets together

Level 4 – Set IP configuration to DHCP (factory default)

Level 5 – Clear SNMP community string to the factory default

Level 6* – Clear the internal PViQ database to the factory default, followed by a Level 3 reset

Level 7* – Reformat the entire file system, including clearing the database, followed by a Level 3 reset

Level 8* – Reset firmware image to factory default, followed by a Level 7 reset. All firmware upgrades performed since installation will be lost.



WARNING: Only qualified technicians should perform these resets. Level 6, 7 and 8 resets will cause the PViQ database to be cleared, losing all current configurations, provisioning and patch field connectivity data. A Level 8 reset will clear all data and reset the PViQ Panel to the factory image and default database settings. **A full firmware update is required after a Level 8 reset.**

To perform a Maintenance Mode Reset:

1. With the panel in Maintenance Mode, press and hold both Function Keys on the PM Interface Unit.

Result: The panel will move through each level of the resets at approximately 5 second intervals. At the end of the initial 5 seconds, the panel will produce a Level 1 reset indication. The unit will beep once a second, and the outer most port LED will change from Red to Green.

If you continue to hold the Function Keys down for another 5 seconds, a Level 2 reset will be indicated. The unit will beep two times per second, and the two outermost port LEDs will change from Red to Green (see below).

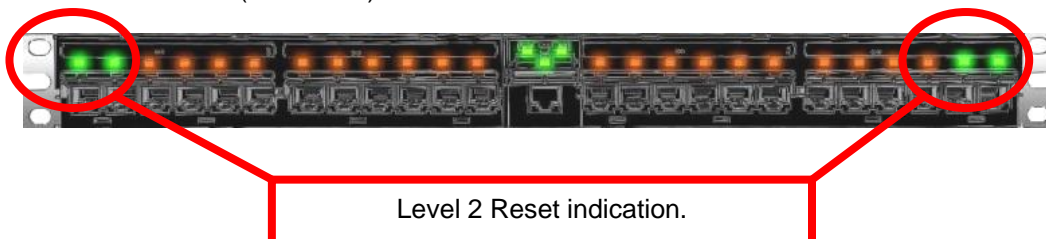

2. When the desired reset level is reached, release both Function Keys simultaneously.

Result: The elected reset level indications will continue for approximately 5 additional seconds, during which the user can confirm or cancel the selected reset.

To **confirm**: press and release the left Confirm Function Key and a beep will follow.

To **cancel**: press and release the right Cancel Function Key, or let the panel simply time out after 5 seconds (the time out will be acknowledged by three short beeps).

After the confirmation, reset level indications will turn off and the system will perform the requested reset.

Exiting Maintenance Mode

When the requested reset is complete, the panel will automatically exit the Maintenance Mode, and will return to the state it was in before the Maintenance Mode was initiated (**Exception**: If the panel was in Trace Mode, it returns to Secure Mode after a reset).

The panel will also exit Maintenance Mode after a 30-minute period of inactivity.

Location Mode

Location Mode is used to provide visual and audio identification cues to locate specific PViQ Patch Panels within a rack.

Identifying Location Mode

In Location Mode, the System Status Indicator LED (SYS), will light solid green. The MAC, Mode, and TRC Indicator LEDs are off. Figure 47 shows the PM in Location Mode.

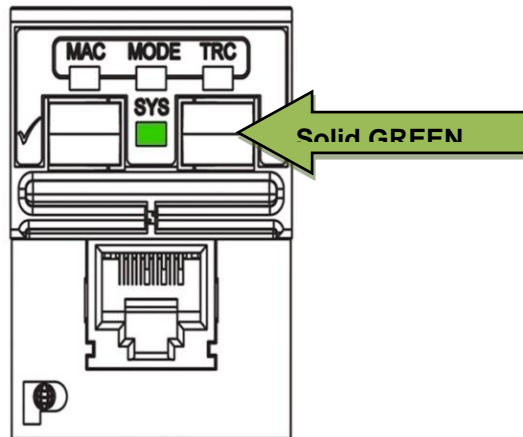
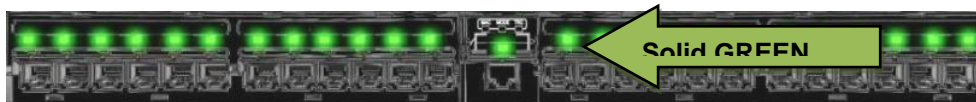

Figure 47 - PM in Location Mode

In addition, all port LEDs will light solid green, and an audible beep will continue to sound.



To silence the audible beep, press the LEFT Function Key once. The port LEDs will remain lit until the panel is taken out of Location Mode.

Entering Location Mode

The PViQ Patch Panels can be put into Location Mode using the CLI `set mode` command, as shown below:

```
set mode <x> location
```

Where <x> is the offset number of the panel.

Exiting Location Mode

To exit Location Mode, and return to Secure Mode, use the CLI `set mode` command, as shown below:

```
set mode <x> secure
```

Where <x> is the offset number of the panel

Mode Identification Summary



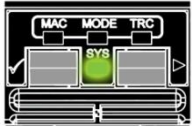
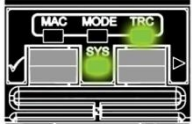
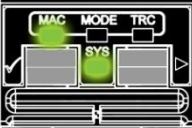
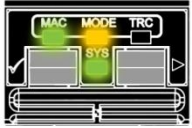
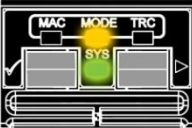
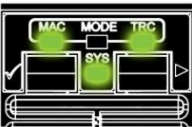

The table below provides a quick reference for identifying the modes of the Interface Unit (IU).

Interface Unit Modes	
	<p>Secure Mode or Location Mode <i>(In Location Mode, all port LEDs will also be Green)</i></p>
	<p>Trace Mode</p>
	<p>MAC Mode</p>
	<p>MAC Mode – single ended connection</p>
	<p>Learn Mode</p>
	<p>Maintenance Mode</p>

Understanding Port LED Indicators

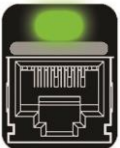
In addition to the LED indicators on the IU, there are also individual LEDs located above each port on the panel. The table below describes the basic states for the ports, and defines the LED colors associated with these states.

- ✓ When the PViQ System Hardware is in the normal operating state (Secure Mode), with no Secure Violations, the Port LED indicators are “off” – that is, the LEDs are not illuminated, regardless of the presence of a patch cord.

Port	LED Status	Meaning
	“off”	Normal Operating State
	Solid Green	Connection successfully “learned” (must be in Learn Mode).
	Flashing Green and Red	Trace is active on this port. If a patch cord is connected, the far end port will also flash.
	Solid Amber	Panel is in Learn Mode, with a single ended connection on this port
	Flashing Green	Move, Add, or Change (MAC) is pending on this port. Waiting for insert.
	Flashing Red	Move, Add, or Change (MAC) is pending on this port. Waiting for remove.

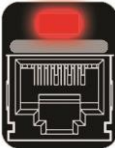
	Solid Red ALL ports	Panel is in Maintenance Mode
	Solid Red ONE port	Secure Violation

PViQ Configuration Options

Introduction

The PViQ System can be configured in two ways:

1. Cross-Connect
2. Interconnect

Either configuration can be used to connect network elements within data centers and telecommunication rooms. Factors such as density of IT assets within racks and cabinets as well as the frequency of asset reconfigurations will determine which method will be most effective.

Cross-Connect

In cross-connect configurations, the more permanent and highest density network element (such as the high-speed switch) is permanently cabled to the back of a PViQ Intelligent Patch Panel with modular jacks. PViQ Patch Cords are then connected between the representative switch-port panel and the PViQ Patch Panel cabled via horizontal runs to remote cabinets. These cabinets typically contain other network elements (such as servers) or endpoint equipment (such as computers, IP phones, security equipment, etc.).

Cross-Connect Data Center Solution

Cross-connect is warranted in data centers where server commissioning/decommissioning and equipment cut-overs necessitate configuration flexibility and cable routing for application re-configurations (see Figure 48).

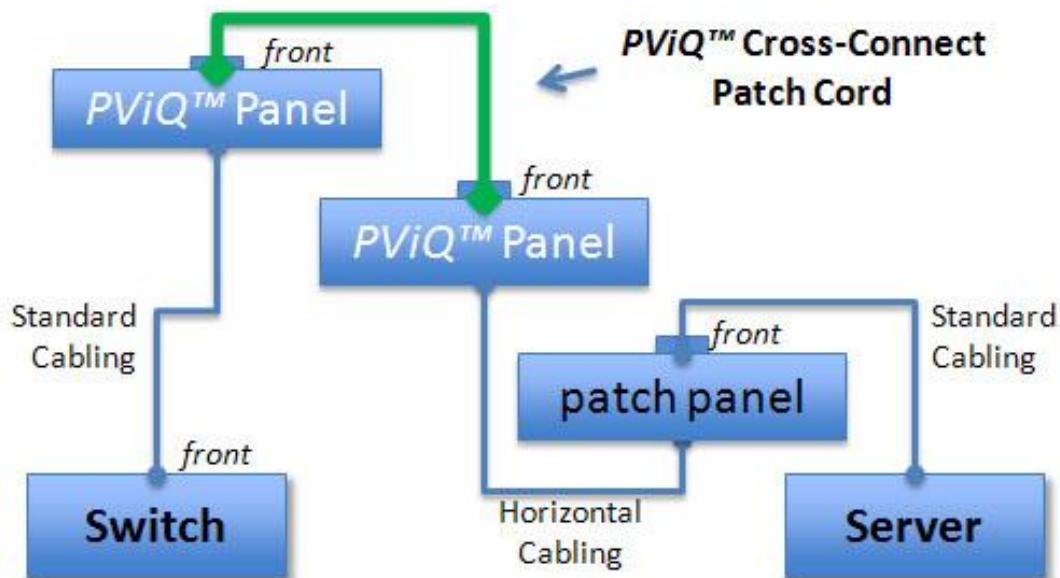

Figure 48 - Cross-Connect Data Center Solution

Cross-Connect Enterprise Solution

The Cross-Connect configuration may also be used in intermediate distribution areas or data-communications closets to reduce the facility reconfiguration costs and cabling time (see Figure 49).

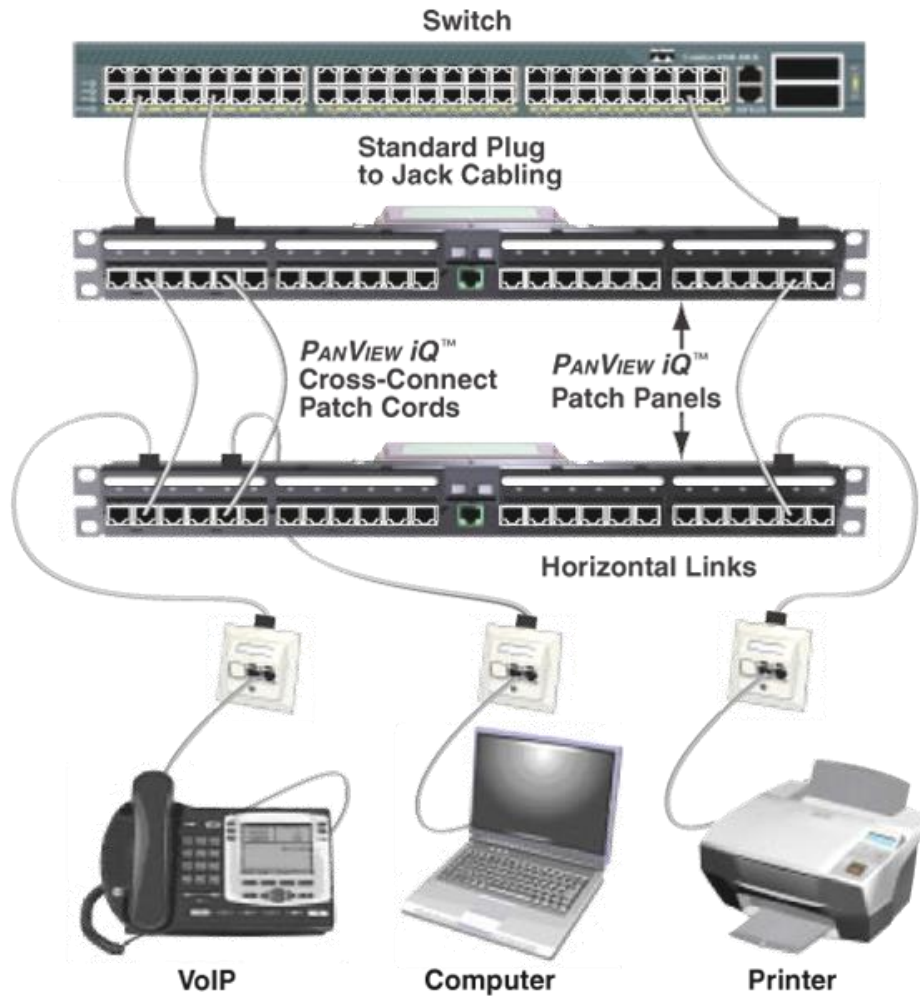

Figure 49 - Cross-Connect Enterprise Solution

Interconnect

Interconnect configurations utilize PViQ Interconnect Patch Cords to provide connectivity between non-PViQ enabled ports and PViQ Patch Panels.

The basic I-Cord may only be used to connect to network elements with shielded jacks. The Enhanced I-Cord may be used to connect to any network element.

Interconnect Data Center Solution

The interconnect configuration is ideal for data center configurations with space limited areas that have lower reconfiguration requirements and utilize higher density connections than other computing areas (see Figure 50).

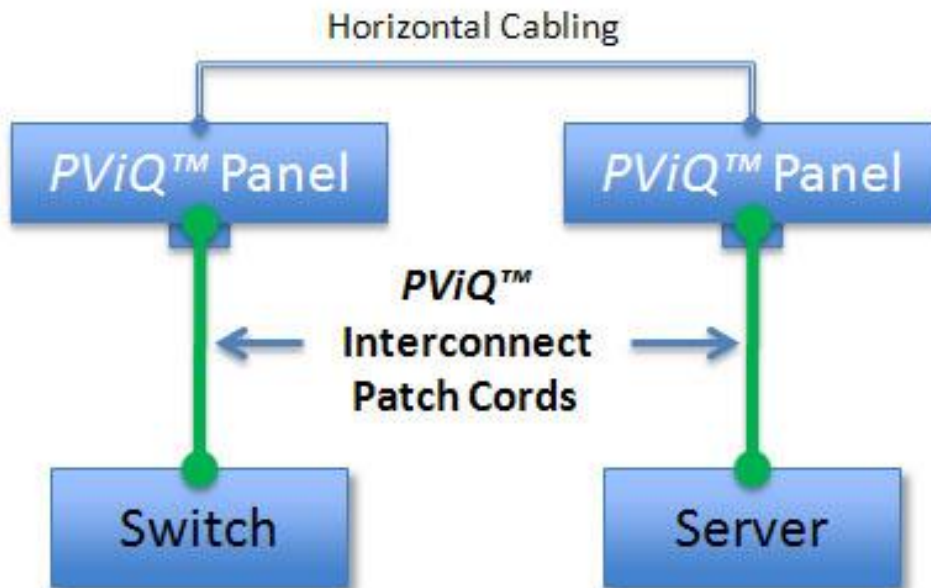

Figure 50 - Interconnect Data Center Solution

Interconnect Enterprise Solution

The interconnect configuration may also be used in an enterprise environment where space is at a premium, and limited moves, adds and changes are expected. (see Figure 51).

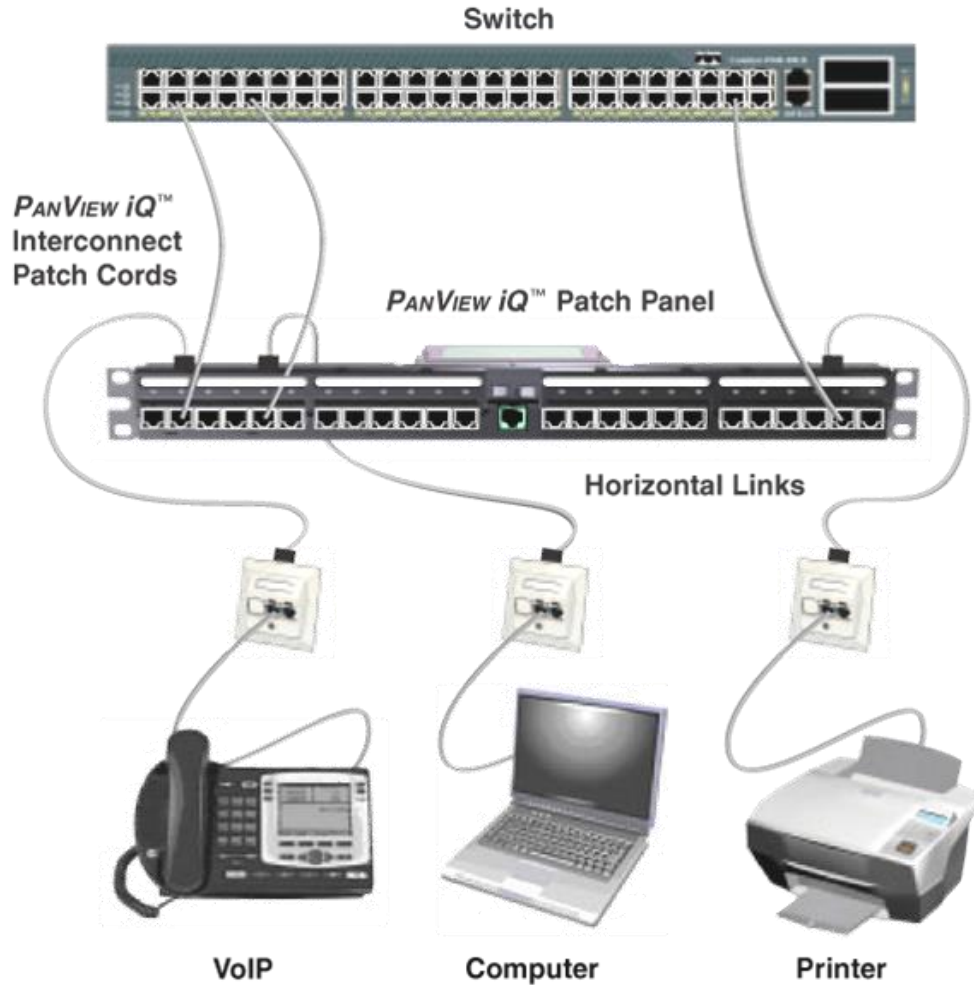

Figure 51 - Interconnect Enterprise Solution

The Provisioning Port on the PM and Interconnect Patch Cords guides installers to the correct switch and panel ports for moves, adds and changes. The PViQ System then detects connections and disconnections made between the switch and PViQ Patch Panels and visually identifies these ports through colored LEDs on the panels, as well as LEDs built into Enhanced PViQ Interconnect Patch Cords.

PViQ Interconnect Patch Cords

Introduction

The PViQ System Hardware utilizes the following styles of Interconnect Patch Cords to support connectivity between non-PViQ enabled ports (switches with shielded jacks, servers with shielded jacks, etc.) and PViQ Patch Panels:

1. PViQ Interconnect Patch Cords (I-Cord)
2. Enhanced PViQ Interconnect Patch Cords (Enhanced I-Cord)
3. PViQ Fiber Interconnect Patch Cords (Fiber I-Cord)

✓ PViQ Interconnect Patch Cords (I-Cords), Enhanced PViQ Patch Cords (Enhanced I-Cords) and PViQ Fiber Interconnect Patch Cords (Fiber I-Cord) are **only compatible with CDP enabled switches**. See below to determine if your switch is compatible .

PIM Switch Support

PIM is compatible with most current major network equipment manufacturer's switch and router products.

For questions about the compatibility of your specific hardware, please contact Panduit Technical Support.

- 1-866-721-5302 (toll-free)
Monday-Friday, 7:30 am - 5:00 pm CST
- systemsupport@panduit.com

PViQ *Basic Interconnect Patch Cord*

The PViQ Basic Interconnect Patch Cord (see Figure 52), also called the "I-Cord," consists of a standard PViQ™ 9-wire patch cord plug on one side, and a special shielded housing on the far end to allow the system to sense double ended connections and provide visual verification at the PViQ Patch Panel.



Figure 52 - PViQ Basic Interconnect Patch Cord

Enhanced PViQ Interconnect Patch Cord

The Enhanced PViQ Interconnect Patch Cord, also called the “Enhanced I-Cord,” builds on the functionality of the basic I-Cord by integrating LEDs directly into the patch cord plug, providing visual verification of accurate patching and tracing activities.

The integrated LEDs also make it easy to identify the far end of I-Cords that have been bunched together and groomed in advance by the installer. The Enhanced I-Cord has a 10-wire plug with separate contacts on each side of an insulation layer.

The Enhanced I-Cord (see Figure 53) indicates and verifies insertion at the switch port, ensuring that the correct networking capabilities are provided for this connection. It also guides removal of interconnect patch cords from both the switch and corresponding PViQ Patch Panel.

The Enhanced I-Cord enables port tracing between PViQ Patch Panels and network switches via local access or remote management. This capability allows for direct mapping and verification of end-to-end patch field connection points.

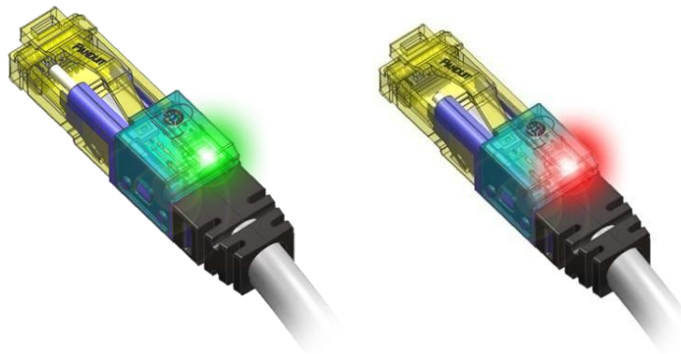

Figure 53 - PViQ Enhanced Interconnect Patch Cord

PViQ Fiber Interconnect Patch Cord

The PViQ Fiber Interconnect Patch Cord (see **Figure 15 - PViQ Fiber Interconnect Patch Cord**), also called the “Fiber I-Cord,” consists of a standard PViQ fiber patch cord plug on one side, and a standard fiber connector on the far end to allow the system to sense PViQ Patch Panel connections and provide visual verification at the PViQ Patch Panel.

Making Connections using PViQ I-Cords

Introduction

This section will provide step-by-step scenarios for utilizing the I-Cord and Enhanced I-Cord.

- ✓ For the purposes of these scenarios, it is assumed that a move, add or change (MAC) order has been issued using the PIM™ Software Platform.

For details on creating a change order using PIM, refer to the **PIM Software User Manual**.

Basic I-Cord Connection

Use the following procedure to make connections using the PViQ Basic I-Cord.

1. After a Move, Add, or Change (MAC) order has been issued, the PM Interface Unit MAC LED lights solid green, and the MODE LED flashes green.

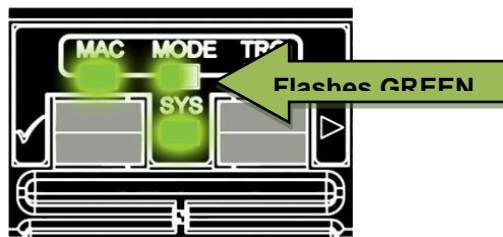

2. Connect the 9-wire side of the I-Cord to the Provisioning Port of the PM. The MODE LED becomes a solid green. The target port LED also lights solid green.

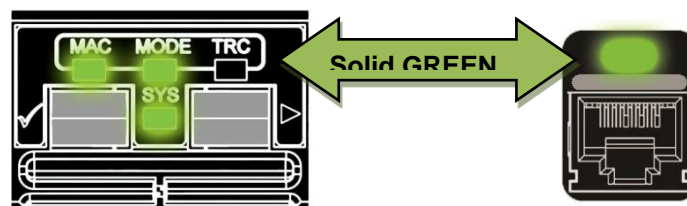

3. Connect the shielded plug end of the I-Cord to the proper jack on the switch. The Mode LED will change to a flashing amber, indicating a single-ended connection. Note: This may take 3-8 seconds depending on the switch.

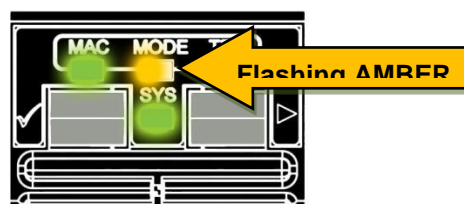

On the PViQ Patch Panel, the Port LED to which the cable should be connected begins flashing green.

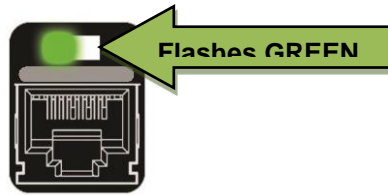

- Remove the I-Cord from the PM Provisioning Port. The MODE LED turns off.

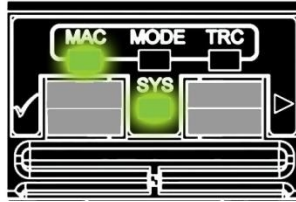

- Connect the I-Cord to the designated port on the PViQ Patch Panel.

The MAC LED turns off, the MODE LED changes to green briefly, then the panel returns to Secure Mode if the MAC is complete on this panel. The Port LED turns off.

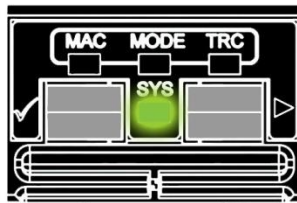

- ✓ **IMPORTANT NOTE:** If the user removes one end of the I-Cord from the patch panel without issuing a work order, a Secure Violation occurs. Simply inserting the I-Cord back into the port will NOT remove the violation. The user MUST perform the provisioning process again.

Basic I-Cord Connection – Incorrect Switch Port

The previous scenario demonstrates the steps of connecting an I-Cord as they would occur if perfectly executed. The procedure in *this* section demonstrates what would occur in a common failure scenario – in this case, a technician plugs far end of the I-Cord into an incorrect switch port..

1. After a Move, Add, or Change (MAC) order has been issued, the PM Interface Unit MAC LED lights solid green, and the MODE LED flashes green.

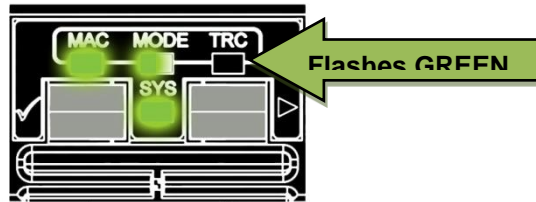

2. Connect the 9-wire side of the I-Cord to the Provisioning Port of the PM. The MODE LED becomes a solid green. The target port LED also lights solid green.

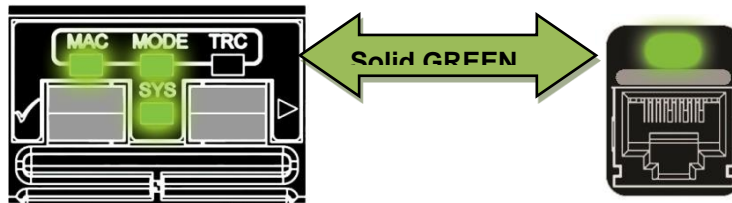

✓ If the target panel is an EM, the PM MAC will extinguish when the I-Cord is removed from the Provisioning Port and the EM MAC LED will stay on until the panel port connection is made.

3. Connect the shielded plug end of the I-Cord to incorrect port on the switch. After a few seconds, the system recognizes the incorrect port. The Mode LED will then change to a flashing RED, indicating an incorrect connection.

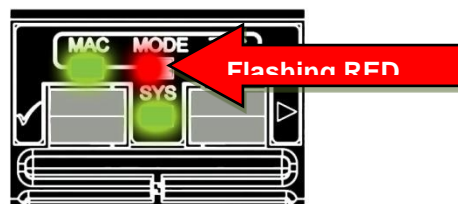

4. Disconnect the far end of the I-Cord from the incorrect port. The MODE LED becomes solid green.

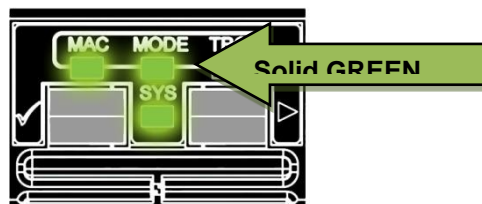

5. Connect the far end of the I-Cord to the proper port on the switch. The Mode LED will change to a flashing amber, indicating a single-ended connection.

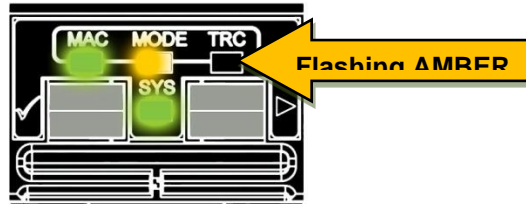

On the PViQ Patch Panel, the Port LED to which the cable should be connected begins flashing green.

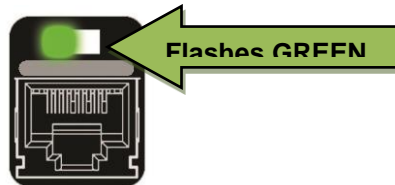

6. Remove the I-Cord from the PM Provisioning Port. The MODE LED turns off.

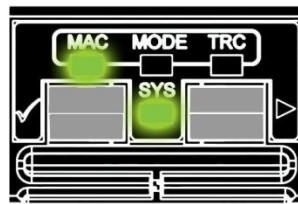

7. Connect the I-Cord to the designated port on the PViQ Patch Panel.

The MAC LED turns off, the MODE LED changes to green briefly, then the panel returns to Secure Mode if the MAC is complete on this panel. The Port LED turns off.

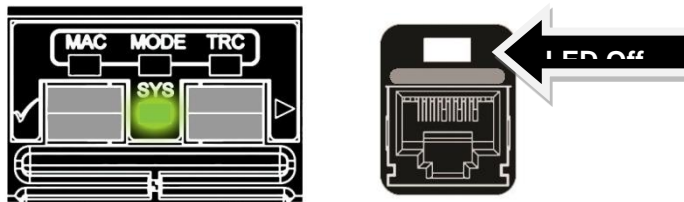

Enhanced I-Cord Connection

Use the following procedure to make connections using the Enhanced PViQ I-Cord.

1. After a Move, Add, or Change (MAC) order has been issued, the PM Interface Unit MAC LED lights solid green, and the MODE LED flashes green.

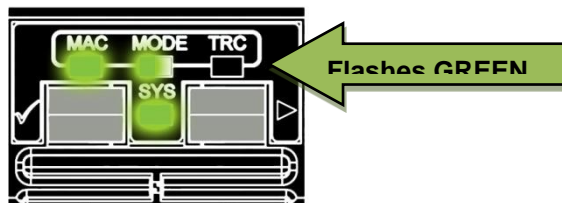

2. Connect the 10-wire side of the I-Cord to the Provisioning Port of the PM. The MODE LED becomes a solid green. The target port LED also lights solid green.

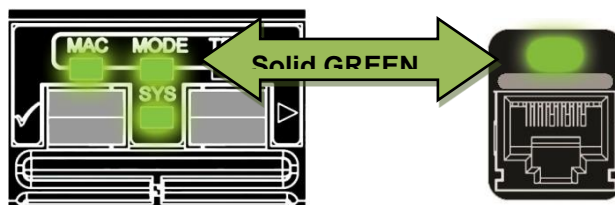

Also, the LED of the Enhanced I-Cord flashes green.



- ✓ If the target panel is an EM, the PM MAC will extinguish when the I-Cord is removed from the Provisioning Port and the EM MAC LED will stay on until the panel port connection is made.

3. Connect the far end of the Enhanced I-Cord to the proper jack on the switch. The Mode LED will change to a flashing amber, indicating a single-ended connection.

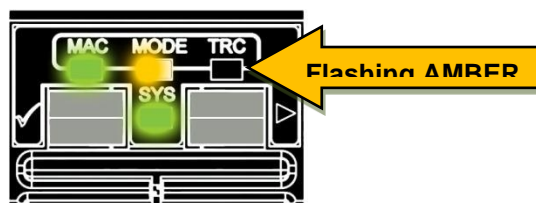

The Enhanced I-Cord LED turns off.

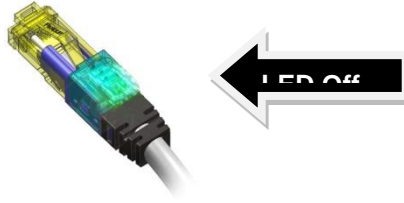

On the PViQ Patch Panel, the Port LED to which the cable should be connected begins flashing green.

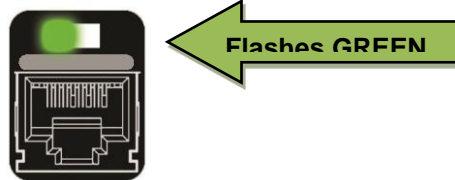

4. Remove the Enhanced I-Cord from the PM Provisioning Port, and connect it to the target port on the PViQ Patch Panel. The MAC and MODE LEDs turn off.

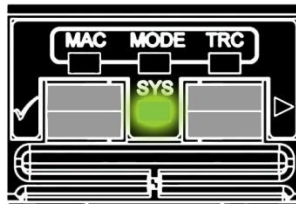

The MODE LED changes to green briefly, then the panel returns to Secure Mode if the MAC is complete for this panel. The Port LED turns off.

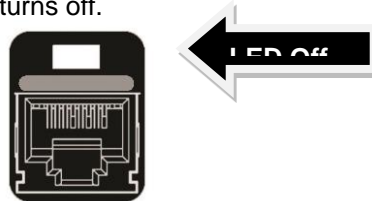

✓ **IMPORTANT NOTE:** If the user removes one end of the I-Cord from the patch panel without issuing a work order, a Secure Violation occurs. Simply inserting the I-Cord back into the port will NOT remove the violation. The user MUST perform the provisioning process again.

Enhanced I-Cord Connection – Incorrect Switch Port

The previous scenario demonstrates the steps of connecting an Enhanced I-Cord as they would occur if perfectly executed. The procedure in *this* section demonstrates what would occur in a common failure scenario – in this case, a technician plugs the LED end of the Enhanced I-Cord into an incorrect switch port.

1. After a Move, Add, or Change (MAC) order has been issued, the PM Interface Unit MAC LED lights solid green, and the MODE LED flashes green.

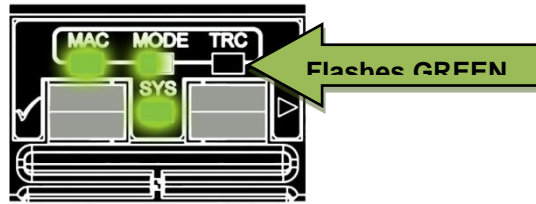

2. Connect the 10-wire side of the I-Cord to the Provisioning Port of the PM. The MODE LED becomes a solid green. The target port LED also lights solid green, identifying the correct port for the connection.

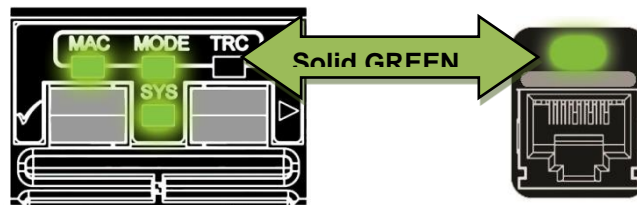

Also, the LED of the Enhanced I-Cord flashes green.



3. Connect the far end of the Enhanced I-Cord to an incorrect port on the switch. The green LED of the Enhanced I-Cord will turn off.

After a few seconds, the system recognizes the incorrect port. The Mode LED will then change to a flashing RED, indicating an incorrect connection.

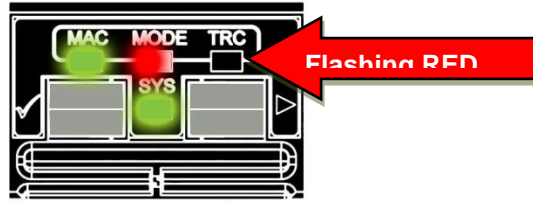

Also, the Enhanced I-Cord LED flashed RED.

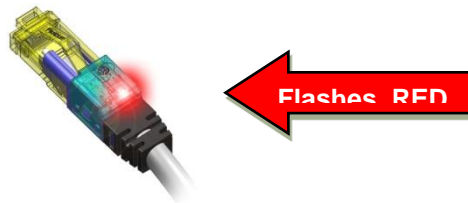

4. Disconnect the far end of the Enhanced I-Cord from the incorrect port. The MODE LED becomes solid green.

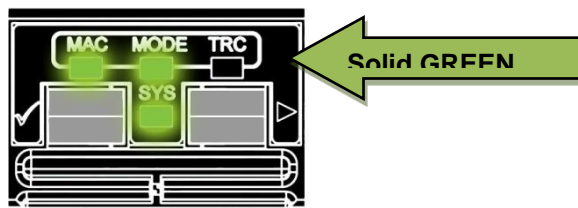

The LED of the Enhanced I-Cord flashes green.



5. Connect the far end of the Enhanced I-Cord to the proper port on the switch. The Mode LED will change to a flashing amber, indicating a single-ended connection.

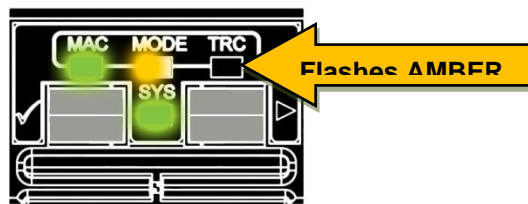

The Enhanced I-Cord LED turns off.

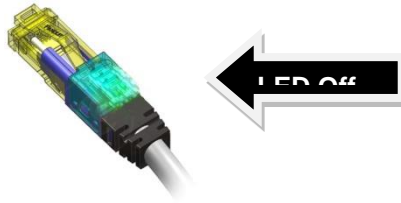

On the PViQ Patch Panel, the Port LED to which the cable should be connected begins flashing green.



6. Remove the Enhanced I-Cord from the PM Provisioning Port. The MODE LED turns off.

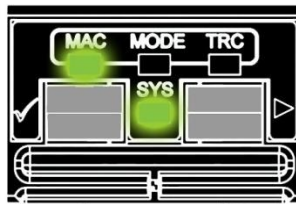

7. Connect the I-Cord to the designated port on the PViQ Patch Panel.

The MAC LED turns off, the MODE LED changes to green briefly, then the panel returns to Secure Mode if the MAC is complete for this panel. The Port LED turns off.

Fiber I-Cord Connection

Adding a connection via a guided MAC is not currently supported. The following procedure provides instructions to make connections using the PIM Teach option. Additional information on the PIM Teach option can be found in the **PIM Software User Manual**.

1. Connect one end of a PViQ Fiber I-Cord to the desired switch port, and the opposite end to the PViQ Fiber Patch Panel. Either end may be connected first. The Port LED on the PViQ Fiber Patch Panel turns on solid red, denoting a secure violation. The PIM connectivity screen the patch port shows a single-ended connection with a secure violation.

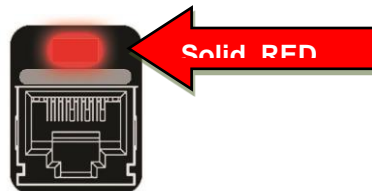

2. Drag the desired fiber switch port to the cell opposite the PViQ Fiber Port in the connectivity window.

- Right-click the connection cell and select **PViQ I-Cord** from the drop-down list. Click **Save** to implement the change.
- PiM sends an accept command to the PViQ Fiber Patch Panel, designating a PViQ I-Cord, and including the appropriate far end information. The PViQ panel saves the connection information and the patch port LED turns off. PiM replaces the single-ended connection icon with a PViQ I-Cord [connected] icon.

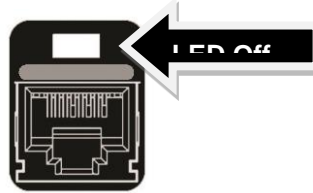

Fiber I-Cord Disconnection

The following procedure provides instructions to disconnect a Fiber I-Cord connection using a guided Move, Add or Change (MAC) order from the PiM software. Additional information on the PiM software can be found in the **PiM Software User Manual**.

- Right-click on the PViQ I-Cord connection icon of the desired switch port and select **Disconnect**. Click **Save**. PiM sends a MAC-delete-interconnect command to the patch panel. The panel prompts by flashing the designated port LED red, and displaying MAC mode on front panel to the desired switch port.



- Unplug the Fiber I-Cord from the PViQ Fiber Patch Panel. The Port LED turns off.

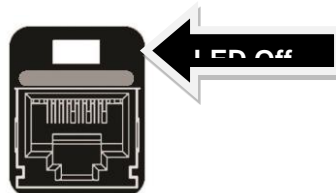

- Right-click the connection cell and select **PViQ I-Cord** from the drop-down list. Click **Save** to implement the change.
- The panel signals end of MAC by returning to secure mode. PiM trusts that the far end has been disconnected and replaces the PViQ I-Cord [connected] icon between the two ports with a no connection icon.

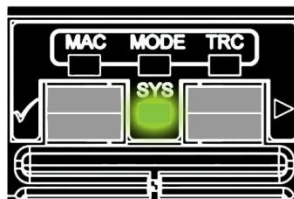

Fiber I-Cord Guided Patching

This section describes the process for adding a connection via a guided MAC.

1. From the PIM Connectivity window, drag (or cut and paste) a fiber switch port to a location opposite the desired connection patch port.
2. Select the connection cell, located between the two fiber switch port cells. Right-click the connection cell and select **PViQ I-Cord** from the drop-down list. Click **Save** to implement the change.

PIM sends a MAC add interconnect command to the PViQ Fiber Patch Panel, designating a PViQ I-Cord, and including the appropriate far end information. The designated port LED flashes **green**.

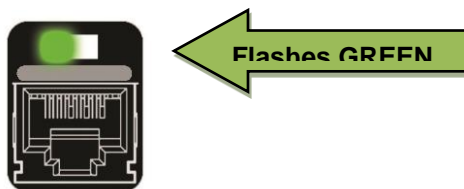

3. Plug in the near-end of the I-Cord to the designated port. The LED turns off.

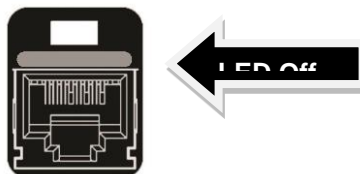

4. The panel signals the end of the MAC by returning to **Secure Mode**. PIM trusts that the far end of the I-Cord is connected to the appropriate switch port, and displays the **Connected** icon in the connection cell.

PViQ Command Line Interface (CLI)

Introduction

The PViQ Command Line Interface (CLI) provides access to a PViQ cluster via a Telnet session.

Through this procedure users can access a specific Panel Manager (PM) and up to three associated Expansion Modules (EMs) through a single Telnet session. This provides control of up to 96 ports on four panels during any given session.

This section provides the following:

- The basic procedure for initiating a CLI session
- The default login and password for the CLI
- The list of commands available
 - Definitions of the parameters for their use
 - Examples of specific commands
 - Examples of the output generated

Using the CLI

Commands entered using the CLI communicate with the PViQ Patch Panels through a Telnet connection to the PM. To establish this connection, you must know the IP address of the PM.

If you do not already know the IP address of your PM, use the following procedure to find the IP address.

Finding the IP Address of the Panel Manager

A Panduit utility called `pviqutil.exe` can be used to find the IP address of the PM. This utility is available on the PViQ System Hardware CD-ROM, or you can download it directly from the Panduit web site:

<http://www.panduit.com/Support/Software/110205>

✓ For more information on finding and setting IP addresses, see **Appendix A, Provisioning PViQ Panel Managers**.

To use this utility to discover the IP address of the PM, follow these steps:

1. Find and make a note of the Media Access Control (MAC) Address of the PM. The MAC is located on MAC Address Label, above the LAN Connectors on the back of the PM. See Figure 54 below.

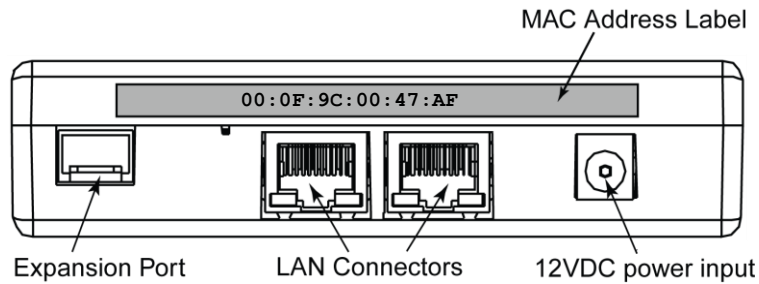

Figure 54 - MAC Address on the PM

2. Explore the PViQ System Hardware CD-ROM and locate the `pviqutil.exe` utility, or download it from the Panduit web site:

<http://www.panduit.com/Support/Software/110205>

3. Copy `pviqutil.exe` to your client machine, placing it in an easily accessible location. For example: `c:\pviqutil.exe`.
4. Activate the Microsoft Command Line Interface by opening the Start Menu and selecting the "Run..." menu item.
5. Type `cmd` in the open line and click OK.
6. Execute the `pviqutil.exe` utility by typing:

```
c:\pviqutil.exe
```

✓ This example assumes that you placed the `pviqutil.exe` file in the `c:` folder as suggested in step 3. If you placed the file in any other location, adjust the pathname appropriately.

You will see a screen similar to Figure 55.

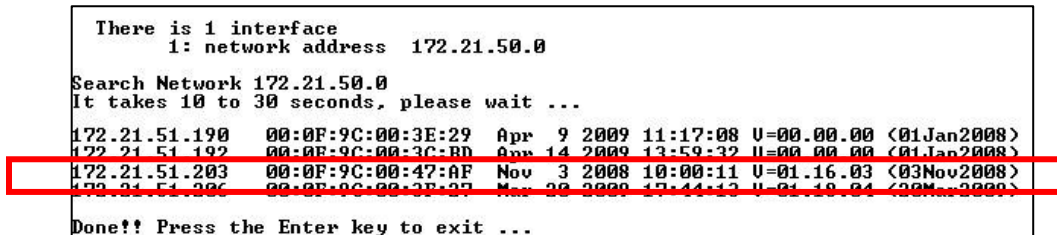

Figure 55 - pviqutil output example

The first column of the output lists all of the IP addresses on this particular network address. The second column is a list of the corresponding Media Access Control (MAC) addresses.

7. Find the MAC address of the PM (which you found in Step 1) on this list, and note the associated IP address. For example, if the MAC address of the PM was:

00:0F:9C:00:47:AF

Then we can determine from the `pviqutil.exe` output that the IP address of the PM is:

172.21.51.203

This is the IP address needed to telnet into the PM.

To Telnet into the Panel Manager

To access the PM via Telnet, perform the following steps:

1. Activate the Microsoft Command Line Interface by opening the Start Menu and selecting the “Run...” menu item
2. Type `cmd` in the open line and click OK.
3. Begin the Telnet session by typing:

```
telnet <IP Address>
```

where <IP Address> is the full IP address of the PM that you found in the previous procedure.

4. Enter a Username and Password. The factory defaults are:

```
Username: admin  
Password: panduit
```

✓ For security purposes, you should change the default password as soon as possible. Use the `config password` command (described later in this section) to change the password.

A screen similar to Figure 56 appears.

```
Welcome to Panduit Shell ...  
This system is to be used by authorized personnel only.  
  
Username:admin  
Password:*****  
  
You are using PAN SHELL command line interface, Version 1.0.0  
Last logon: Unavailable  
  
PSH >
```

Figure 56 - Pan Shell CLI ready

You are now ready to begin entering Pan Shell CLI commands. The next section details the available commands.

CLI Commands

The following table lists the available CLI commands and provides definitions and other information for their use.

- ✓ From within the CLI, you may type “?” to receive a listing of all possible commands. You can also narrow your search by entering a basic command (such as config or show) followed by the “?” For example:

```
PSH > show ?
```

Command	Definition and use
config	<p>Allows configuration of various components and variables, as shown below:</p> <p>config contactname <name> Configures the contact name for this PViQ cluster. The variable <name> is a 256 byte free format string.</p> <p>config devicename <name> Configures the device name for this PViQ cluster. The variable <name> is a 256 byte free format string.</p> <p>config offsetname <offset><name> Configures the name for this PViQ Patch Panel. The variable <name> is a 256 byte free format string.</p> <p>config ip Displays the current IP configuration.</p> <p>config ip commit config [-type] [-address] [-mask] [-gateway] Sets or changes the current IP configurations using the entered parameters</p> <p>config ntp Configures the Network Time Server.</p> <p>config password <password> Sets the password to the entered string.</p> <p>config physloc <location> Sets the physical location variable to the entered location. The variable <location> is a 256 byte free</p>

format string.

config rackname <1-4> <name>

Sets the Rack Name variable for a given panel (1-4) to the entered name. The variable <name> is a 256 byte free format string.

config rackposition <1-4> <position>

Sets the Rack Position variable for a given panel (1-4) to the entered numeric position. The variable <position> is a numeric value, typically between 1 and 45.

config snmp <disable | enable> <all | provision | rear> <v1v2c | v3>

Enables or disables SNMP on an Ethernet port.

config snmp -read <name>

Sets the SNMP v1/v2c read community string.

config snmp -trapcom <1-5> <name>

Sets the SNMP v1/v2c trap community string.

config snmp -trapip <1-5> <IP address>

Sets the SNMP v1/v2c trap receiver IP address. Up to 5 separate receivers are allowed.

config snmp -trapon <1-5> <all | none | [crit] [maj] [min] [adv]

Enables/disables/filters SNMP v1/v2c traps for the specific receiver.

config snmp -write <name>

Sets the SNMP v1/v2c write community string.

config timeout <minutes>

Sets the command idle timeout time in minutes. By default the telnet session will timeout after 10 minutes of inactivity. The timeout time is specified in minutes. Maximum value is 30000 minutes (approximately 20 days).

config trapver <1-5> <v1 | v2 | v3 >

Sets the Trap Version for traps sent to v1/v2c/v3 trap receiver.

config username add <name> <password>

Adds a User Name and Password to the database

✓ This username will not have all the privileges of the admin username

config username delete <name>

Deletes a User Name from the database.

	<p>✓ Admin username cannot be deleted</p>
exit	Ends the telnet session
ping	<p>Pings the requested IP address, as shown below:</p> <p style="text-align: center;">ping <Dotted IP Address></p> <p>Example: ping 172.21.51.203</p>
quit	Ends the telnet session
reset	<p>Performs a Reset of the system. There are eight levels of reset available, as described below:</p> <p>reset system <1-8></p> <ul style="list-style-type: none"> 1 = reset the PM 2 = reset all the EMs 3 = reset the PM and all EMs 4 = obtain a new IP address from the DHCP Server 5 = clear the SNMP community string 6 = clear the database 7 = clear the file system 8 = revert all hardware to factory settings <div style="border: 1px solid black; background-color: #f0f0f0; padding: 5px; margin-top: 10px;"> <p> CAUTION: Only qualified technicians should perform these resets. Level 6, 7 and 8 resets will cause the PViQ database to be cleared, losing all current configuration, provisioning and patch field connectivity data.</p> </div>
set	<p>Sets various parameters within the system, as shown below:</p> <p>set email alert <email address> [always daily weekday Saturday Sunday] Establishes rules for receiving email alerts.</p> <p>set email rate <email address> <emails-per-hour-per-event> Sets the allowable number of emails per hour, per event for a given email address.</p>

	<p>set email trap [add delete] <trap number> Adds an email trap number (or set of trap numbers) to the database, or deletes an email trap number (or set of trap numbers) from the database.</p> <p>set email user [add delete] <email address> Adds an email user (or set of users) to the database, or deletes an email user (or set of users) from the database.</p> <p>set http <on off> Turn http on or off</p> <p>set mode <1-4> <learn location secure> Sets the mode of a given panel (1,2,3, or 4). For example, to set panel 1 to the secure mode, enter: set mode 1 secure</p> <p>set paneltype application [offset offset.port] [copper multimode singlemode fieldterm default] Override the current application for an individual panel, or reset the default value.</p> <p>set paneltype shape [offset] [angled flat default] Override the current shape for an individual panel, or reset the default value.</p> <p>set paneltype shielding [offset] [shielded unshielded default] Override the current shielding type for an individual panel, or reset the default value.</p> <p>set pmail account <IP address> <email address> <password> Sets the Panel Manager email account.</p> <p>set smtp <on off> Turn smtp on or off</p> <p>set time mm/dd/yyyy hh:mm:ss Set the time for the PM. Hours are input in 00-23 format.</p> <p>set timeout <minutes> By default the telnet session will timeout after 10 minutes of inactivity. The timeout time is specified in minutes. Maximum value is 30000 minutes (approximately 20 days).</p> <p>set timezone behind:ahead utc number-of-minutes Sets the parameters for system timezone</p>
--	--

<i>show</i>	<p>Displays the current setting for various parameters within the system. See examples below:</p> <p>show config Displays all of the configuration parameters of the system.</p> <p>show contactname Displays the designated Contact Name for the system.</p> <p>show devicename Displays the current setting for the Device Name.</p> <p>show email alert Displays the current setting for the email alerts.</p> <p>show email user Displays the current setting for email user.</p> <p>show fw Displays the current firmware revision of the PM.</p> <p>show hw Displays the current hardware serial numbers and model types.</p> <p>show ip Displays the current IP address of the PM.</p> <p>show mac Displays the current MAC address of the PM.</p> <p>show mode Displays the current mode of each panel.</p> <p>show ntpconfig Displays the current ntp settings.</p> <p>show offsetname Displays the current name of each panel.</p> <p>show paneltype Displays a chart of the current Shape, Shielding type and Application for PViQ panels. Also displays whether or not the panel settings have been modified from the default settings.</p> <p>show physloc Displays the current setting for the Physical Location.</p>
--------------------	---

	<p>show pmemail account Displays the current setting for the PM email account.</p> <p>show port <1-4> Displays the patch field status for all the ports in a specified offset</p> <p>show rackname Displays the current setting for the Rack Name.</p> <p>show rackposition Displays the current setting for the Rack Position.</p> <p>show snmp Displays the current settings for SNMP v1/v2c/v3.</p> <p>show time Displays the current setting for time and date.</p> <p>show timeout Displays the current command idle timeout in minutes.</p> <p>show traplog <count> Displays the most recent traps received by the traplog. The number of traps displayed is equal to the <count> parameter. Entering the command without parameters with show all 128 traplog entries.</p> <p>show username Displays the current parameter settings for the default User Name.</p> <p>show topology Displays the current topology for the system.</p>
start	<p>Starts the various updates and processes as shown below:</p> <p>start email alert <email-address> Initiates the sending of email alerts to the email-address specified.</p> <p>start fwupdate <Server-IP> <filename> Initiates a firmware update, accessing the update file (filename) from the server IP address (Server-IP)</p> <p>✓ Because some operating systems may convert uppercase letters to lowercase, ensure that <filename> contains only lowercase letters.</p>

	start fwupdatepic Initiates a PIC update.
stop	Stop a process or procedure, as shown below. stop email alert <email-address> Stops email alerts initiated with the start command.
help	List available parameters for a given command, or lists all available commands. For example: config help

Output Examples of Common CLI Commands

This section contains examples of the output for several common CLI commands, and gives information on the use.

To display the current configuration parameters

```
PSH > config ip
```

```
PSH > config ip
IP Type ..... : dynamic          Committed    Pending
IP Address ..... : 172.21.50.42  dynamic      dynamic
Subnet Mask ..... : 255.255.254.0
Gateway ..... : 172.21.50.1
DNS Server ..... : 172.16.36.19
Physical Address ... : 00:0f:9c:00:47:af
```

Example 1 – config ip

To display and change the current modes of the panels

```
PSH > show mode
```

```
PSH > show mode
Offset current      previous
 1 Secure           Learn
 2 Secure           Learn
 3 Secure           Learn
 4 Secure           Learn
```

Example 2 - show mode

In *Example 2*, the all of the PViQ Patch Panels are in SECURE mode. You could change the **third panel** (offset 3) to Learn Mode by entering:

```
PSH > Set mode 3 learn
```

The output of the Show Mode command would then change as shown below:

```
PSH > set mode 3 learn
PSH > show mode
Offset current      previous
 1 Secure           Learn
 2 Secure           Learn
 3 Learn            Secure
 4 Secure           Learn
```

Example 3 - show mode

To display the current Firmware Revision

```
PSH > show fw
```

```
PSH > show fw
Firmware Updates: Total:0001 Last: IP-172.21.51.157, File-pviq_fw_01_22_04
-----
FLASH Images
-----
PMM (bootloader):
  MBL v0.4 (07Oct2007)
PMM (application):
  Jun  4 2009 14:42:15 #PVIQ:FW Version 01.22.04 (04Jun2009) Serpentine #[FAC
-01.14.04]
PEPIC:
  May 11 2009 14:45:50!0x400f0000!001.004!
  May 11 2009 14:45:50!0x400f0000!001.004!
WPBIC:
  May 22 2009 15:02:33!0x40110100!000.075!099099
PPPIC:
  May 22 2009 15:03:08!0x40140280!000.011!
-----
Running Images
-----
PP:
<01: > HW:90 BL:000.002 AP:000.011
PE:
<01:..> HW:00 BL:000.007 AP:001.004
<02:..> HW:02 BL:000.007 AP:001.004
<03:..> HW:02 BL:000.007 AP:001.004
<04:..> HW:02 BL:000.007 AP:001.004
```

Example 4 - show fw

- ✓ The screen capture in Example 4 shows the hardware data for the PM (labeled as “PE: 1” or Panel Element 1). The remaining elements are not shown.

To display Port information for a given panel

```
PSH > Show Port 3
```

```
PSH > show port 3
NEOffset NEPort MM State      FEMAC      FEOffset FEPort
3         01      DISC
3         02      DISC
3         03      DISC
3         04      DISC
3         05      DISC
3         06      DISC
3         07      9WD      00:0F:9C:00:47:AF      1      19
3         08      DISC
3         09      DISC
3         10      DISC
3         11      DISC
3         12      DISC
3         13      9WD      00:0F:9C:00:47:AF      1      7
3         14      DISC
3         15      DISC
3         16      DISC
3         17      DISC
3         18      DISC
3         19      DISC
3         20      DISC
3         21      DISC
3         22      DISC
3         23      DISC
3         24      9WD      00:0F:9C:00:47:AF      4      1
```

Example 5 - show port