



WTB12-3P1131

W12-3

SMALL PHOTOELECTRIC SENSORS

SICK
Sensor Intelligence.



Illustration may differ



Ordering information

Type	Part no.
WTB12-3P1131	1041413

Included in delivery: BEF-KH-W12 (2)

Other models and accessories → www.sick.com/W12-3

Detailed technical data

Features

Functional principle	Photoelectric proximity sensor
Functional principle detail	Background suppression
Sensing range max.	20 mm ... 350 mm ¹⁾
Sensing range	20 mm ... 350 mm
Emitted beam	
Light source	LED ²⁾
Type of light	Visible red light
Light spot size (distance)	Ø 6 mm (200 mm)
Key LED figures	
Wave length	640 nm
Adjustment	Potentiometer, 5 turns
Items supplied	2 x clamps BEF-KH-W12, incl. screws

¹⁾ Object with 90% remission (based on standard white, DIN 5033).

²⁾ Average service life: 100,000 h at T_J = +25 °C.

Safety-related parameters

MTTF_D	599 years
DC_{avg}	0 %

Electrical data

Supply voltage U_B	10 V DC ... 30 V DC ¹⁾
Ripple	< 5 V _{pp} ²⁾
Current consumption	45 mA ³⁾
Protection class	III
Digital output	
Type	PNP
Switching mode	Light/dark switching
Signal voltage PNP HIGH/LOW	> U _v - 2,5 V / ca. 0 V
Output current I _{max.}	≤ 100 mA
Response time	≤ 330 μs ⁴⁾
Switching frequency	1,500 Hz ⁵⁾
Output function	Complementary
Circuit protection	A ⁶⁾ C ⁷⁾ D ⁸⁾

¹⁾ Limit values when operated in short-circuit protected network: max. 8 A.

²⁾ May not exceed or fall below U_v tolerances.

³⁾ Without load.

⁴⁾ Signal transit time with resistive load.

⁵⁾ With light/dark ratio 1:1.

⁶⁾ A = V_S connections reverse-polarity protected.

⁷⁾ C = interference suppression.

⁸⁾ D = outputs overcurrent and short-circuit protected.

Mechanical data

Housing	Rectangular
Dimensions (W x H x D)	15.6 mm x 48.5 mm x 42 mm
Connection	Cable, 4-wire, 2 m ¹⁾
Connection detail	
Conductor size	0.25 mm ²
Length of cable (L)	2 m ¹⁾
Material	
Housing	Metal
Front screen	Plastic, PMMA
Cable	PVC
Weight	200 g

¹⁾ Do not bend below 0 °C.

Ambient data

Enclosure rating	IP66 IP67 IP69K
Ambient operating temperature	-40 °C ... +60 °C
Ambient temperature, storage	-40 °C ... +75 °C

UL File No.	NRKH.E181493 & NRKH7.E181493
--------------------	------------------------------

Classifications

ECLASS 5.0	27270904
ECLASS 5.1.4	27270904
ECLASS 6.0	27270904
ECLASS 6.2	27270904
ECLASS 7.0	27270904
ECLASS 8.0	27270904
ECLASS 8.1	27270904
ECLASS 9.0	27270904
ECLASS 10.0	27270904
ECLASS 11.0	27270904
ECLASS 12.0	27270903
ETIM 5.0	EC002719
ETIM 6.0	EC002719
ETIM 7.0	EC002719
ETIM 8.0	EC002719
UNSPSC 16.0901	39121528

Adjustments

WTB12-3, WTF12-3, potentiometer

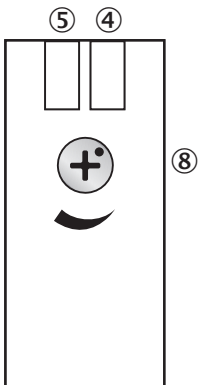

- ④ LED indicator green: Supply voltage active
- ⑤ LED indicator yellow: Status of received light beam
- ⑧ Sensing range adjustment: potentiometer

Connection type

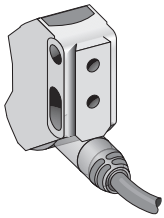

Connection diagram

Cd-094

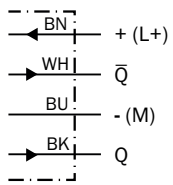

Characteristic curve

WTB12-3, red light, 350 mm

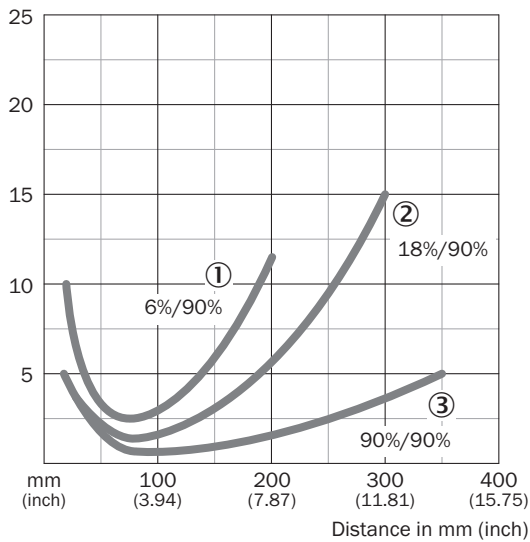

- ① Sensing range on black, 6% remission factor
- ② Sensing range on gray, 18% remission factor
- ③ Sensing range on white, 90% remission factor

Sensing range diagram

WTB12-3, red light, 350 mm

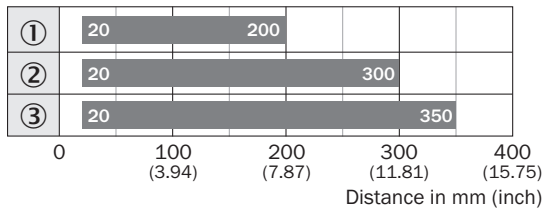

■ Sensing range

- ① Sensing range on black, 6% remission factor
- ② Sensing range on gray, 18% remission factor
- ③ Sensing range on white, 90% remission factor

Dimensional drawing (Dimensions in mm (inch))

WTB12-3, potentiometer

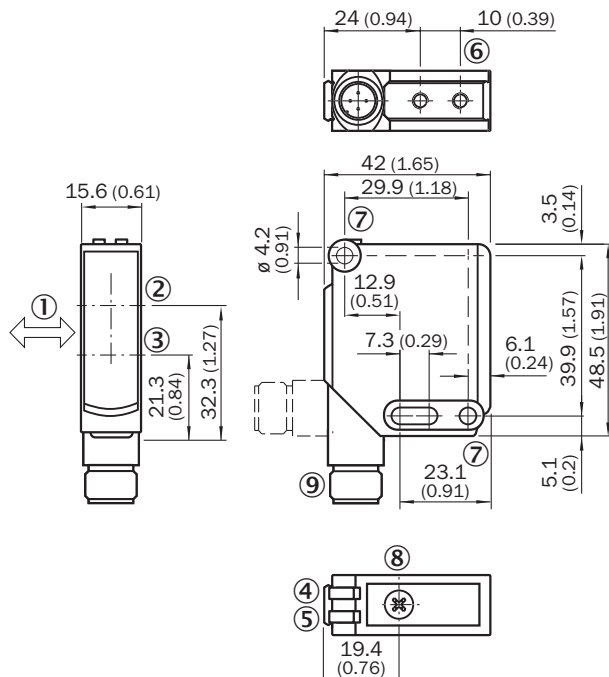

- ① Standard direction of the material being detected
- ② Optical axis, receiver
- ③ Optical axis, sender
- ④ LED indicator green: Supply voltage active
- ⑤ LED indicator yellow: Status of received light beam
- ⑥ M4 threaded mounting hole, 4 mm deep
- ⑦ Mounting hole, \varnothing 4.2 mm
- ⑧ Sensing range adjustment: potentiometer
- ⑨ Connection

Recommended accessories

Other models and accessories → www.sick.com/W12-3

	Brief description	Type	Part no.
Plug connectors and cables			
	<ul style="list-style-type: none">• Connection type head A: Male connector, M12, 4-pin, straight• Description: Unshielded• Connection systems: Screw-type terminals• Permitted cross-section: ≤ 0.75 mm²	STE-1204-G	6009932

SICK AT A GLANCE

SICK is one of the leading manufacturers of intelligent sensors and sensor solutions for industrial applications. A unique range of products and services creates the perfect basis for controlling processes securely and efficiently, protecting individuals from accidents and preventing damage to the environment.

We have extensive experience in a wide range of industries and understand their processes and requirements. With intelligent sensors, we can deliver exactly what our customers need. In application centers in Europe, Asia and North America, system solutions are tested and optimized in accordance with customer specifications. All this makes us a reliable supplier and development partner.

Comprehensive services complete our offering: SICK LifeTime Services provide support throughout the machine life cycle and ensure safety and productivity.

For us, that is “Sensor Intelligence.”

WORLDWIDE PRESENCE:

Contacts and other locations –www.sick.com