



IHM06-02BNSVT0G

IMM

INDUCTIVE PROXIMITY SENSORS

**SICK**  
Sensor Intelligence.



### Ordering information

Type	Part no.
IHM06-02BNSVTOG	1101126

Other models and accessories → [www.sick.com/IMM](http://www.sick.com/IMM)

Illustration may differ



### Detailed technical data

#### Features

<b>Housing</b>	Cylindrical smooth housing
<b>Housing</b>	Extremely short model
<b>Diameter</b>	Ø 6.5 mm
<b>Sensing range <math>S_n</math></b>	2 mm
<b>Safe sensing range <math>S_a</math></b>	1.62 mm
<b>Installation type</b>	Flush
<b>Switching frequency</b>	5,000 Hz
<b>Connection type</b>	Connector M8, 3-pin
<b>Switching output</b>	NPN
<b>Output function</b>	NO
<b>Electrical wiring</b>	DC 3-wire
<b>Enclosure rating</b>	IP67 <sup>1)</sup>
<b>Special features</b>	Visual adjustment indicator

<sup>1)</sup> According to EN 60529.

#### Mechanics/electronics

<b>Supply voltage</b>	10 V DC ... 30 V DC
<b>Ripple</b>	≤ 20 % <sup>1)</sup>
<b>Voltage drop</b>	≤ 2 V <sup>2)</sup>
<b>Time delay before availability</b>	≤ 50 ms
<b>Hysteresis</b>	1 % ... 10 %
<b>Reproducibility</b>	≤ 2 % <sup>3)</sup>
<b>Temperature drift (of <math>S_n</math>)</b>	≤ 10 %

<sup>1)</sup> Of  $V_S$ .

<sup>2)</sup> With  $I_a = 200$  mA.

<sup>3)</sup> Supply voltage  $U_B$  and constant ambient temperature  $T_a$ .

<b>EMC</b>	EN 60947-5-2
<b>Continuous current I<sub>a</sub></b>	≤ 200 mA
<b>Short-circuit protection</b>	✓
<b>Reverse polarity protection</b>	✓
<b>Power-up pulse protection</b>	✓
<b>Shock and vibration resistance</b>	30 g, 11 ms / 10 ... 55 Hz, 1 mm
<b>Ambient operating temperature</b>	-25 °C ... +70 °C
<b>Housing material</b>	Stainless steel V2A, DIN 1.4305 / AISI 303
<b>Sensing face material</b>	Plastic, LCP
<b>Housing length</b>	29 mm
<b>UL File No.</b>	NRKH.E348498

1) Of V<sub>S</sub>.

2) With I<sub>a</sub> = 200 mA.

3) Supply voltage U<sub>B</sub> and constant ambient temperature T<sub>a</sub>.

### Safety-related parameters

<b>MTTF<sub>D</sub></b>	1,330 years
<b>DC<sub>avg</sub></b>	0 %

### Reduction factors

<b>Note</b>	The values are reference values which may vary
<b>St37 steel (Fe)</b>	1
<b>Stainless steel (V2A, 304)</b>	Approx. 0.75
<b>Aluminum (Al)</b>	Approx. 0.5
<b>Copper (Cu)</b>	Approx. 0.43
<b>Brass (Br)</b>	Approx. 0.54

### Installation note

<b>Remark</b>	Associated graphic see "Installation"
<b>B</b>	6 mm
<b>C</b>	6.5 mm
<b>D</b>	6 mm
<b>F</b>	16 mm

### Classifications

<b>ECLASS 5.0</b>	27270101
<b>ECLASS 5.1.4</b>	27270101
<b>ECLASS 6.0</b>	27270101
<b>ECLASS 6.2</b>	27270101
<b>ECLASS 7.0</b>	27270101
<b>ECLASS 8.0</b>	27270101
<b>ECLASS 8.1</b>	27270101
<b>ECLASS 9.0</b>	27270101
<b>ECLASS 10.0</b>	27270101

<b>ECLASS 11.0</b>	27270101
<b>ECLASS 12.0</b>	27274001
<b>ETIM 5.0</b>	EC002714
<b>ETIM 6.0</b>	EC002714
<b>ETIM 7.0</b>	EC002714
<b>ETIM 8.0</b>	EC002714
<b>UNSPSC 16.0901</b>	39122230

### Adjustments

Installation aid

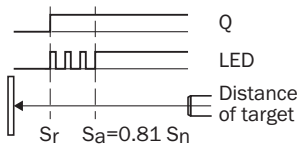

### Installation note

Fixing with setscrew

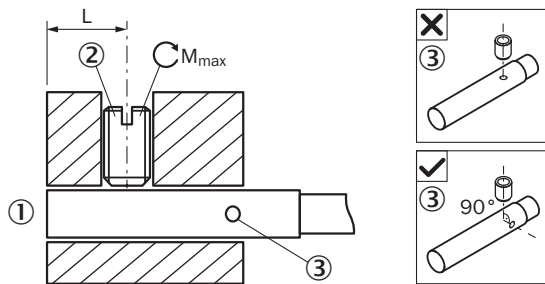

- ① Sensing face
- ② Recommended setscrew: M3, flat point
- ③ Display LED

Sensor type	Mounting area (L)	Max. tightening torque ( $M_{max}$ )
IHM06-*****G	6 mm ... 11 mm	≤ 0.4 Nm
IHM06-*****TOG	6 mm ... 21 mm	≤ 0.4 Nm
IHM06-*****K	6 mm ... 21 mm	≤ 0.4 Nm
IHM06-*****TOK	6 mm ... 32 mm	≤ 0.4 Nm
IHM06-*****S	6 mm ... 32 mm	≤ 0.4 Nm
IHM06-*****TOS	6 mm ... 42 mm	≤ 0.4 Nm

Mounting using BEF-KH-M06 bracket



Sensor type	Mounting adapter	Overrun (P)	Max. tightening torque (M <sub>max</sub> )
IHM06-1B5***** IHM06-02B***** IHM06-03B*****	BEF-KH-M06, part no. 2101067	≥ 0 mm	≤ 0.6 Nm

Flush installation

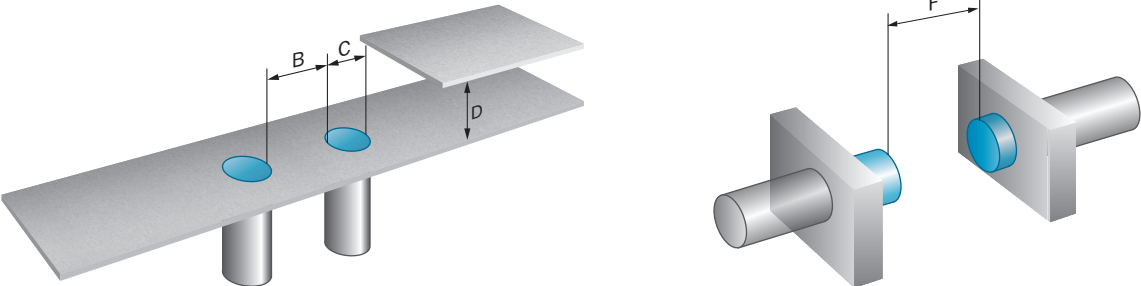

Connection diagram

Cd-002

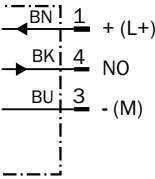

Response diagram

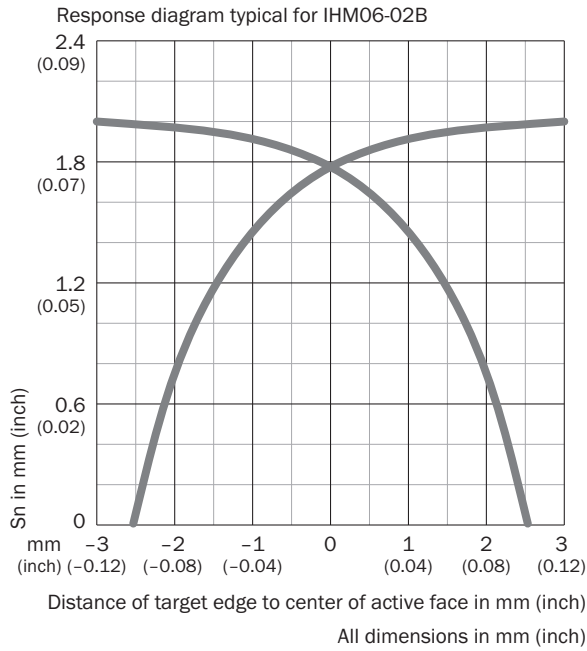

Dimensional drawing (Dimensions in mm (inch))

IHM06, extremely short variant, flush, male connector

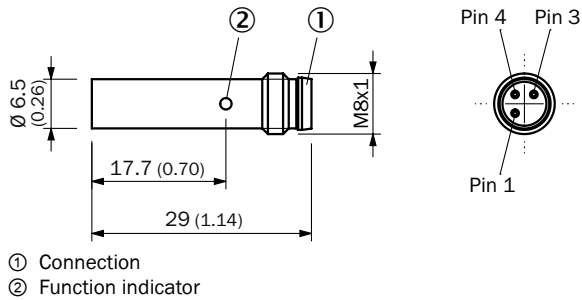







Recommended accessories



Other models and accessories → [www.sick.com/IMM](http://www.sick.com/IMM)

	Brief description	Type	Part no.
Plug connectors and cables			
	<ul style="list-style-type: none"> <li>• <b>Connection type head A:</b> Male connector, M8, 3-pin, straight</li> <li>• <b>Description:</b> Unshielded</li> <li>• <b>Connection systems:</b> Screw-type terminals</li> <li>• <b>Permitted cross-section:</b> 0.14 mm<sup>2</sup> ... 0.5 mm<sup>2</sup></li> </ul>	STE-0803-G	6037322

	Brief description	Type	Part no.
	<ul style="list-style-type: none"> <li>• <b>Connection type head A:</b> Male connector, M8, 3-pin, angled</li> <li>• <b>Description:</b> Unshielded</li> <li>• <b>Connection systems:</b> Screw-type terminals</li> <li>• <b>Permitted cross-section:</b> 0.14 mm<sup>2</sup> ... 0.5 mm<sup>2</sup></li> </ul>	STE-0803-WSK	6053170
Terminal and alignment brackets			
	Plastic (PA6), without mounting hardware	BEF-KH-M06	2101067
Others			
	<ul style="list-style-type: none"> <li>• <b>Connection type head A:</b> 3-pin</li> <li>• <b>Slot connection type:</b> M8, 3-pin, A-coded, female connector</li> <li>• <b>Description:</b> Unshielded</li> <li>• <b>Items supplied:</b> 5 x labeling plates</li> </ul>	Y8A34A2-C2A8000XXX	2115733
		Y8A36A2-C2A8000XXX	2115734
	<ul style="list-style-type: none"> <li>• <b>Connection type head A:</b> 3-pin</li> <li>• <b>Slot connection type:</b> M8, 3-pin, A-coded, female connector</li> <li>• <b>Cable:</b> 5 m, 6-wire, PUR, halogen-free</li> <li>• <b>Description:</b> Unshielded</li> <li>• <b>Application:</b> Drag chain operation</li> <li>• <b>Items supplied:</b> 5 x labeling plates</li> </ul>	Y8A34A2-LXXXUAA050	2115727
	<ul style="list-style-type: none"> <li>• <b>Connection type head A:</b> 3-pin</li> <li>• <b>Slot connection type:</b> M8, 3-pin, A-coded, female connector</li> <li>• <b>Cable:</b> 5 m, 8-wire, PUR, halogen-free</li> <li>• <b>Description:</b> Unshielded</li> <li>• <b>Application:</b> Drag chain operation</li> <li>• <b>Items supplied:</b> 5 x labeling plates</li> </ul>	Y8A36A2-LXXXUBA050	2115728
	<ul style="list-style-type: none"> <li>• <b>Connection type head A:</b> Female connector, M8, 3-pin, straight, A-coded</li> <li>• <b>Connection type head B:</b> Flying leads</li> <li>• <b>Signal type:</b> Sensor/actuator cable</li> <li>• <b>Cable:</b> 2 m, 3-wire, PUR, halogen-free</li> <li>• <b>Description:</b> Sensor/actuator cable, unshielded</li> <li>• <b>Application:</b> Zones with oils and lubricants, Drag chain operation, Robot</li> </ul>	YF8U13-020UA1XLEAX	2094782
	<ul style="list-style-type: none"> <li>• <b>Connection type head A:</b> Female connector, M8, 3-pin, straight, A-coded</li> <li>• <b>Connection type head B:</b> Flying leads</li> <li>• <b>Signal type:</b> Sensor/actuator cable</li> <li>• <b>Cable:</b> 5 m, 3-wire, PUR, halogen-free</li> <li>• <b>Description:</b> Sensor/actuator cable, unshielded</li> <li>• <b>Application:</b> Zones with oils and lubricants, Drag chain operation, Robot</li> </ul>	YF8U13-050UA1XLEAX	2094788
	<ul style="list-style-type: none"> <li>• <b>Connection type head A:</b> Female connector, M8, 3-pin, straight, A-coded</li> <li>• <b>Connection type head B:</b> Flying leads</li> <li>• <b>Signal type:</b> Sensor/actuator cable</li> <li>• <b>Cable:</b> 2 m, 3-wire, PVC</li> <li>• <b>Description:</b> Sensor/actuator cable, unshielded</li> <li>• <b>Application:</b> Zones with chemicals</li> </ul>	YF8U13-020VA1XLEAX	2095860
	<ul style="list-style-type: none"> <li>• <b>Connection type head A:</b> Female connector, M8, 3-pin, straight, A-coded</li> <li>• <b>Connection type head B:</b> Flying leads</li> <li>• <b>Signal type:</b> Sensor/actuator cable</li> <li>• <b>Cable:</b> 5 m, 3-wire, PVC</li> <li>• <b>Description:</b> Sensor/actuator cable, unshielded</li> <li>• <b>Application:</b> Zones with chemicals</li> </ul>	YF8U13-050VA1XLEAX	2095884
	<ul style="list-style-type: none"> <li>• <b>Connection type head A:</b> Female connector, M8, 3-pin, angled, A-coded</li> <li>• <b>Connection type head B:</b> Flying leads</li> <li>• <b>Signal type:</b> Sensor/actuator cable</li> <li>• <b>Cable:</b> 2 m, 3-wire, PUR, halogen-free</li> <li>• <b>Description:</b> Sensor/actuator cable, unshielded</li> <li>• <b>Application:</b> Zones with oils and lubricants, Drag chain operation, Robot</li> </ul>	YG8U13-020UA1XLEAX	2094794

	Brief description	Type	Part no.
	<ul style="list-style-type: none"> <li>• <b>Connection type head A:</b> Female connector, M8, 3-pin, angled, A-coded</li> <li>• <b>Connection type head B:</b> Flying leads</li> <li>• <b>Signal type:</b> Sensor/actuator cable</li> <li>• <b>Cable:</b> 5 m, 3-wire, PUR, halogen-free</li> <li>• <b>Description:</b> Sensor/actuator cable, unshielded</li> <li>• <b>Application:</b> Zones with oils and lubricants, Drag chain operation, Robot</li> </ul>	YG8U13-050UA1XLEAX	2095586
	<ul style="list-style-type: none"> <li>• <b>Connection type head A:</b> Female connector, M8, 3-pin, angled, A-coded</li> <li>• <b>Connection type head B:</b> Flying leads</li> <li>• <b>Signal type:</b> Sensor/actuator cable</li> <li>• <b>Cable:</b> 2 m, 3-wire, PVC</li> <li>• <b>Description:</b> Sensor/actuator cable, unshielded</li> <li>• <b>Application:</b> Zones with chemicals</li> </ul>	YG8U13-020VA1XLEAX	2096165
	<ul style="list-style-type: none"> <li>• <b>Connection type head A:</b> Female connector, M8, 3-pin, angled, A-coded</li> <li>• <b>Connection type head B:</b> Flying leads</li> <li>• <b>Signal type:</b> Sensor/actuator cable</li> <li>• <b>Cable:</b> 5 m, 3-wire, PVC</li> <li>• <b>Description:</b> Sensor/actuator cable, unshielded</li> <li>• <b>Application:</b> Zones with chemicals</li> </ul>	YG8U13-050VA1XLEAX	2096166
	<ul style="list-style-type: none"> <li>• <b>Connection type head A:</b> Female connector, M8, 3-pin, straight, A-coded</li> <li>• <b>Connection type head B:</b> Male connector, M12, 3-pin, straight, A-coded</li> <li>• <b>Signal type:</b> Sensor/actuator cable</li> <li>• <b>Cable:</b> 2 m, 3-wire, PUR, halogen-free</li> <li>• <b>Description:</b> Sensor/actuator cable, unshielded</li> <li>• <b>Application:</b> Zones with oils and lubricants, Drag chain operation, Robot</li> </ul>	YF8U13-020UA1M2A13	2096169
	<ul style="list-style-type: none"> <li>• <b>Connection type head A:</b> Female connector, M8, 3-pin, straight, A-coded</li> <li>• <b>Connection type head B:</b> Male connector, M12, 3-pin, straight, A-coded</li> <li>• <b>Signal type:</b> Sensor/actuator cable</li> <li>• <b>Cable:</b> 5 m, 3-wire, PUR, halogen-free</li> <li>• <b>Description:</b> Sensor/actuator cable, unshielded</li> <li>• <b>Application:</b> Zones with oils and lubricants, Drag chain operation, Robot</li> </ul>	YF8U13-050UA1M2A13	2096170
	<ul style="list-style-type: none"> <li>• <b>Connection type head A:</b> Female connector, M8, 3-pin, straight, A-coded</li> <li>• <b>Connection type head B:</b> Male connector, M12, 3-pin, straight, A-coded</li> <li>• <b>Signal type:</b> Sensor/actuator cable</li> <li>• <b>Cable:</b> 2 m, 3-wire, PVC</li> <li>• <b>Description:</b> Sensor/actuator cable, unshielded</li> <li>• <b>Application:</b> Zones with chemicals</li> </ul>	YF8U13-020VA1M2A13	2096605
	<ul style="list-style-type: none"> <li>• <b>Connection type head A:</b> Female connector, M8, 3-pin, straight, A-coded</li> <li>• <b>Connection type head B:</b> Male connector, M12, 3-pin, straight, A-coded</li> <li>• <b>Signal type:</b> Sensor/actuator cable</li> <li>• <b>Cable:</b> 5 m, 3-wire, PVC</li> <li>• <b>Description:</b> Sensor/actuator cable, unshielded</li> <li>• <b>Application:</b> Zones with chemicals</li> </ul>	YF8U13-050VA1M2A13	2096606
	<ul style="list-style-type: none"> <li>• <b>Connection type head A:</b> Female connector, M8, 3-pin, angled, A-coded</li> <li>• <b>Connection type head B:</b> Male connector, M12, 3-pin, straight, A-coded</li> <li>• <b>Signal type:</b> Sensor/actuator cable</li> <li>• <b>Cable:</b> 2 m, 3-wire, PUR, halogen-free</li> <li>• <b>Description:</b> Sensor/actuator cable, unshielded</li> <li>• <b>Application:</b> Zones with oils and lubricants, Drag chain operation, Robot</li> </ul>	YG8U13-020UA1M2A13	2095748
	<ul style="list-style-type: none"> <li>• <b>Connection type head A:</b> Female connector, M8, 3-pin, straight, A-coded</li> <li>• <b>Connection type head B:</b> Male connector, M8, 3-pin, straight, A-coded</li> <li>• <b>Signal type:</b> Sensor/actuator cable</li> <li>• <b>Cable:</b> 2 m, 3-wire, PUR, halogen-free</li> <li>• <b>Description:</b> Sensor/actuator cable, unshielded</li> <li>• <b>Application:</b> Zones with oils and lubricants, Drag chain operation, Robot</li> </ul>	YF8U13-020UA1M8U13	2096304
	<ul style="list-style-type: none"> <li>• <b>Connection type head A:</b> Female connector, M8, 3-pin, straight, A-coded</li> <li>• <b>Connection type head B:</b> Male connector, M8, 3-pin, straight, A-coded</li> <li>• <b>Signal type:</b> Sensor/actuator cable</li> <li>• <b>Cable:</b> 5 m, 3-wire, PUR, halogen-free</li> <li>• <b>Description:</b> Sensor/actuator cable, unshielded</li> <li>• <b>Application:</b> Zones with oils and lubricants, Drag chain operation, Robot</li> </ul>	YF8U13-050UA1M8U13	2096308



	Brief description	Type	Part no.
	<ul style="list-style-type: none"> <li>• <b>Connection type head A:</b> Female connector, M8, 3-pin, angled, A-coded</li> <li>• <b>Connection type head B:</b> Male connector, M8, 3-pin, straight, A-coded</li> <li>• <b>Signal type:</b> Sensor/actuator cable</li> <li>• <b>Cable:</b> 2 m, 3-wire, PUR, halogen-free</li> <li>• <b>Description:</b> Sensor/actuator cable, unshielded</li> <li>• <b>Application:</b> Zones with oils and lubricants, Drag chain operation, Robot</li> </ul>	YG8U13-020UA1M8U13	2107781
	<ul style="list-style-type: none"> <li>• <b>Connection type head A:</b> Female connector, M8, 3-pin, angled, A-coded</li> <li>• <b>Connection type head B:</b> Male connector, M12, 3-pin, straight, A-coded</li> <li>• <b>Signal type:</b> Sensor/actuator cable</li> <li>• <b>Cable:</b> 5 m, 3-wire, PUR, halogen-free</li> <li>• <b>Description:</b> Sensor/actuator cable, unshielded</li> <li>• <b>Application:</b> Zones with oils and lubricants, Drag chain operation, Robot</li> </ul>	YG8U13-050UA1M2A13	2122842

## SICK AT A GLANCE

SICK is one of the leading manufacturers of intelligent sensors and sensor solutions for industrial applications. A unique range of products and services creates the perfect basis for controlling processes securely and efficiently, protecting individuals from accidents and preventing damage to the environment.

We have extensive experience in a wide range of industries and understand their processes and requirements. With intelligent sensors, we can deliver exactly what our customers need. In application centers in Europe, Asia and North America, system solutions are tested and optimized in accordance with customer specifications. All this makes us a reliable supplier and development partner.

Comprehensive services complete our offering: SICK LifeTime Services provide support throughout the machine life cycle and ensure safety and productivity.

For us, that is “Sensor Intelligence.”

## WORLDWIDE PRESENCE:

Contacts and other locations –[www.sick.com](http://www.sick.com)