

Part number

# TAPH 06 L32

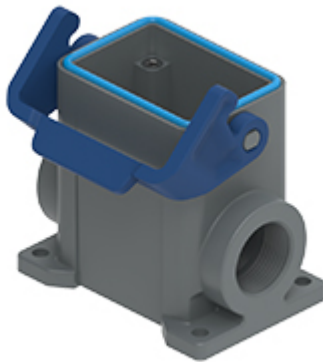

Surface mounting housing, T-TYPE /H series,  
with 1 lever, M32 cable entry, size "44.27"

Product description		Material properties	
<b>Product type</b>	Surface mounting housing	<b>Main material</b>	Polypropylene (PP)
<b>Series</b>	T-TYPE /H	<b>Other materials</b>	Lever: Polypropylene (PP), metal-detectable Gasket: HNBR
<b>Closing type</b>	With 1 lever	<b>Colour</b>	RAL 7012 grey, RAL 5005 blue
<b>Size</b>	Size 44.27	<b>RoHS conformity</b>	Compliant
<b>Cable entry</b>	With cable entry M32	<b>China RoHS - EFUP</b>	E
Technical data		<b>REACH SVHC substances</b>	No
<b>IP degree of protection</b>	IP66 / IP69	General ordering information	
Further technical details		<b>EAN13 code</b>	8015747209885
<b>Weight</b>	130,00 g	<b>eCl@ss 8.1</b>	27440202
<b>Operating temperature range (min, max)</b>	-40°C ... +70°C	<b>ETIM 7.0</b>	EC000437
		Packaging Information	
		<b>Packaging length</b>	180,00 mm
		<b>Packaging height</b>	210,00 mm
		<b>Packaging width</b>	330,00 mm
		<b>Packaging weight</b>	3,07 kg
		<b>Packaging volume</b>	12,47 dm <sup>3</sup>
		<b>Packaging description</b>	Carton box
		<b>Packaging quantity</b>	20 Pcs
		<b>Packaging EAN code</b>	8015747210034
		<b>Sub-packaging weight</b>	0,77 kg
		<b>Sub-packaging description</b>	Plastic packaging
		<b>Sub-packaging quantity</b>	5 Pcs
		<b>Sub-packaging EAN barcode</b>	8015747210041

Part number

# TAPH 06 L32



## Catalogue drawings

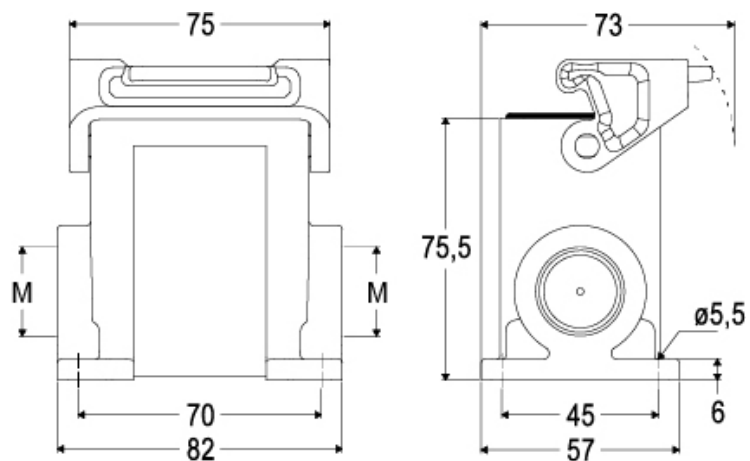

## Notes

Dimensions shown in mm are not binding and may be changed without notice.