

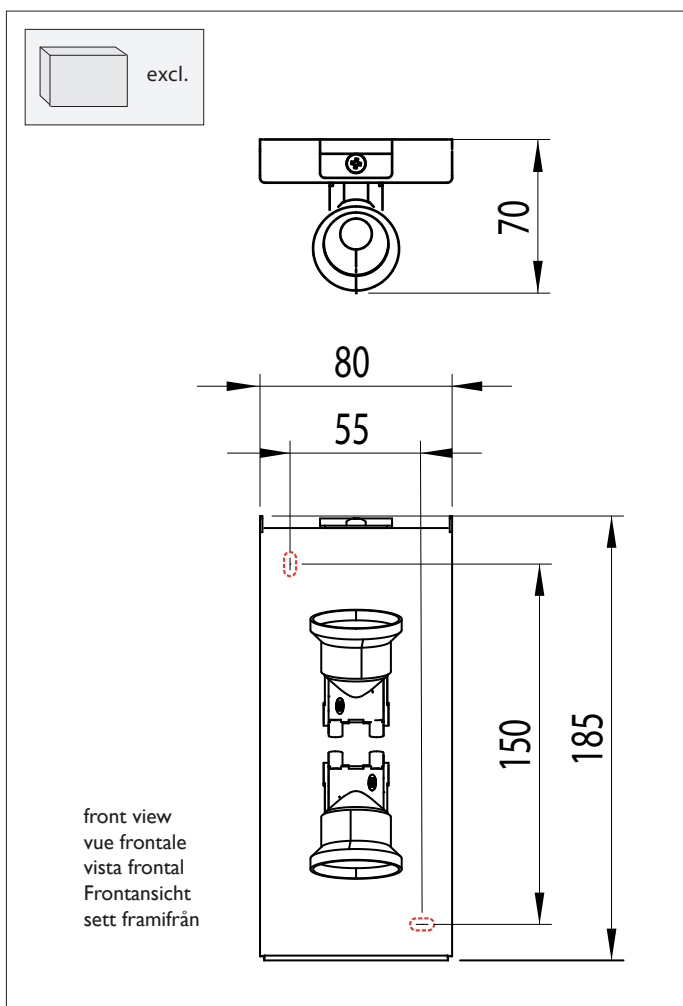

# 7096 Backplate I

**astro**

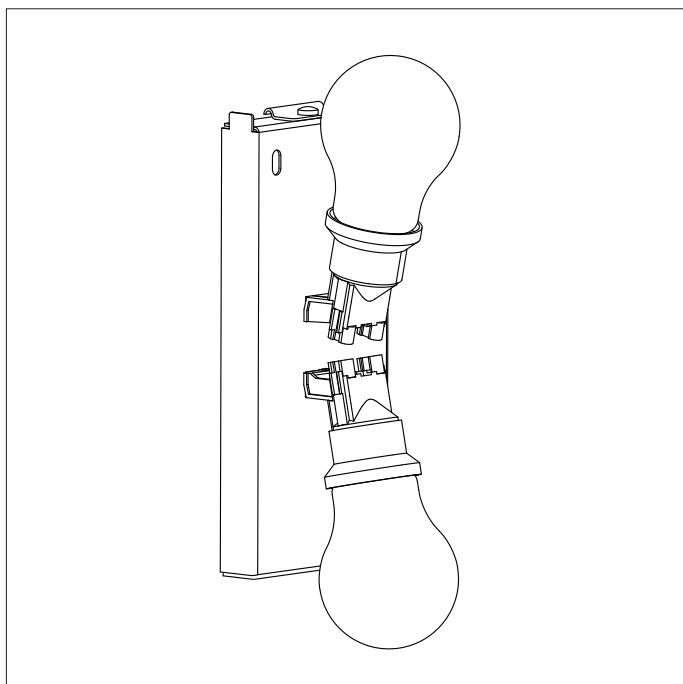

2 x 60w  
E27  excl.

Zone 3

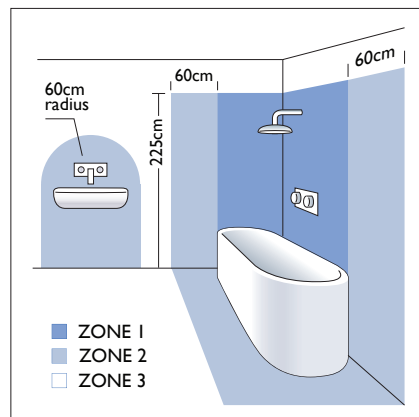
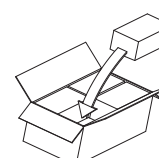















































**x 24**

Astro Lighting Ltd.  
G2 River Way, Harlow  
CM20 2DP, Great Britain

T: +44 (0) 1279 427001  
F: +44 (0) 1279 427002  
sales@astrolighting.co.uk  
www.astrolighting.co.uk

# Data Sheet Key

				
	Class 1	Classe 1	Schutzklasse 1	Classe 1
	Class 2	Classe 2	Schutzklasse 2	Classe 2
	Class 3	Classe 3	Schutzklasse 3	Classe 3
	Luminaire suitable for direct mounting on normally flammable surfaces	Apparecchio di illuminazione per installazione diretta su superfici infiammabili	Leuchte verwendbar für direkte Montage auf normalerweise feuergefährlichen Oberflächen	Luminaire montage sur surface en matériau inflammable autorisé
	No protection against water ingress	Nessuna protezione contro l'immersione in acqua	Kein Schutz vor eindringendem Wasser	Pas de protection contre la pénétration d'eau
	Splash-proof	Antispruzzo	Spritzwasser-geschützt	Résistant aux éclaboussures
	Jet-proof	Antigetto	Strahlwasser-geschützt	Résistant aux jets d'eau
	Weight of product in box	Poids du produit emballé	Gewicht der Ware im Karton	Peso di prodotto in scatola
	Dimmable	Dimmerabile	Dimmbar	Dimmable
	Touch dimmer	Touch dimmer	Touch dimmer	Touch dimmer
	Glass component	Component in vetro	Glas	Verre
	With on/off switch or pull cord	Con interruttore on/off o a tirante	mit An/Ausschalter oder Zugband	avec interrupter on/off ou tirette
	Cut out size	foro di incasso	Ausschnittsmaß	Dimensions d'encastrement
	Magnification	Ingrandimento	Vergrößerung	Grossissement
	Fire-rated	Ignifugo	schwer entflammbar	résistant au feu
	Aluminium	Alluminio	Aluminium	Aluminium
	Ceramic	Ceramica	Crema	Céramique
	Fabric	Tissu	Stoff	Tessuto
	Glass	Vetro	Glas	Verre
	Plaster	Gesso	Gips	Plâtre
	Plastic	Plastique	Kunststoff	Plastica
	Stainless steel	Acciaio inox	Edelstahl	Acier Inoxydable
	Steel	Acier	Stahl	Acciaio
	Wood	Bois	Holz	Legno
	Zinc	Zinc	Zink	Zinco

				
	Antique Brass	Ottone Antico	Messing Antik	Laiton Antique
	Brushed Aluminium	Alluminio Spazzolato	Aluminium Gebürstet	Aluminium Brossé
	Black	Nero	Schwarz	Noir
	Brushed Nickel	Nickel Spazzolato	Nickel Gebürstet	Nickel Brossé
	Bronze	Bronzo	Bronze	Bronze
	Clear Glass	Vetro Transparente	Klares Glas	Verre Claire
	Frosted	Smerigliato	Matt	Verre Satiné
	Mirror	Specchio	Spiegel	Miroir
	Matt Nickel	Nickel Opaco	Nickel Matt	Nickel Mat
	Natural Brass	Nickel Opaco	Nickel Matt	Nickel Mat
	Oak Finish	Acabado Roble	Eichenfinish	Finition Chêne
	Polished Aluminium	Alluminio Brillante	Aluminium Poliert	Aluminium Poli
	Polished Chrome	Cromo Brillante	Chrom Poliert	Chrome Poli
	Polished Nickel	Nickel Brillante	Nickel Poliert	Nickel Poli
	Painted Silver	Argento Verniciato	Silber Lackiert	Peinture Argent
	Satin Chrome	Cromo Satinato	Chrom Satiniert	Chrome Satiné
	Stainless Steel	Acciaio Inox	Edestahl	Acier Inoxydable
	Walnut	Noce	Walnussfinish	Finition Noyer
	White	Bianco	Weiß	Blanc



Quantity of products per shipping box

Colisage

Anzahl der Produkte pro Versandeinheit

Quantità di prodotti per scatola di spedizione