

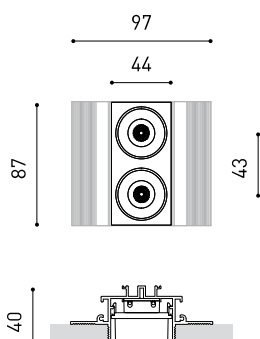

## DIMENSIONS



## ACCESSOIRES

CUSTOM & MOUNTING  
ACCESSORIES

DRIVER OPTIONS

## TROPHÉES



Nom	BLACK FOSTER 2 FLOOD 2700K NMG
Référence	A3172000NMG
Couleur	Noir Mat-Or métallique
RAL	Finition métallique
Catégorie	CUSTOM SYSTEMS

Type	LED
Flux lumineux brut	380 lm
Température de couleur	2700 K
Stabilité chromatique	MacAdam Step 3
Indice de reproduction chromatique	CRI > 90
Puissance	4,2 W
Courant	700 mA
Efficacité	90 lm/W
Durée de vie de la LED	L80B10 > 60.000h

## SOURCE DE LUMIÈRE

## LUMINAIRE | DONNÉS PHOTOMÉTRIQUES

Efficacité lumineuse	92%
Angle du faisceau lumineux	38°

## LUMINAIRE | DONNÉS ÉLECTRIQUES

Driver	Exclu: Doit être déporté
Variation d'intensité	Non Dim / DALI / Push / 1-10V
Classe d'isolation électrique	III

## D'AUTRES DONNÉES

Étanchéité	IP20
Contrôle sans fil	Veuillez consulter
Alimentation d'urgence	Veuillez consulter
Poids	180 g
Poids avec emballage	275 g
Dimensions de l'emballage	212 x 155 x 73 mm
Unités par emballage	1
Matériaux	Aluminium / Acrylonitrile Butadiène Styrène / Polycarbonate



Black Foster est le luminaire qui transfère l'effet acclamé de 'The Invisible Black' à un système linéaire. Black Foster est composé d'une série de modules combinables qui permet d'alterner dans le luminaire des segments avec émission de lumière et d'autres sans lumière. Cependant, aussi bien allumé qu'éteint, le luminaire conserve toujours l'esthétique d'une parfaite ligne sombre. Pour l'observateur, il est impossible de différencier les parties de Black Foster qui émettent de la lumière de celles qui n'en émettent pas. \*\*\* NOTE: Seulement pour les installations où le profil peut être installé avant le faux plafond. Carton-plâtre de 12,5 mm d'épaisseur.

DIAGRAMME POLAIRE



DIAGRAMME CONIQUE



UGR

Glare Evaluation According to UGR												
ρ Ceiling		70	70	50	50	30	70	70	50	50	30	30
ρ Walls		50	30	50	30	30	50	30	50	30	30	30
ρ Floor		20	20	20	20	20	20	20	20	20	20	20
Room Size X Y		Viewing direction at right angles to lamp axis					Viewing direction parallel to lamp axis					
2H	2H	-10.8	-10.1	-10.5	-9.9	-9.7	-10.4	-9.7	-10.1	-9.6	-9.4	-9.4
	3H	-5.7	-5.1	-5.4	-4.9	-4.7	-5.5	-4.9	-5.2	-4.6	-4.4	-4.4
	4H	-2.8	-2.3	-2.5	-2.0	-1.8	-2.4	-1.8	-2.1	-1.6	-1.3	-1.3
	6H	0.7	1.2	1.0	1.4	1.7	0.9	1.4	1.2	1.7	2.0	2.0
	8H	2.5	3.0	2.9	3.3	3.6	2.7	3.1	3.0	3.4	3.7	3.7
4H	12H	4.5	5.0	4.9	5.3	5.6	4.6	5.1	5.0	5.4	5.7	5.7
	2H	-9.1	-8.6	-8.8	-8.3	-8.1	-8.9	-8.4	-8.6	-8.1	-7.9	-7.9
	3H	-3.9	-3.5	-3.6	-3.2	-2.9	-3.7	-3.3	-3.4	-3.0	-2.7	-2.7
	4H	-0.9	-0.5	-0.6	-0.2	0.1	-0.6	-0.2	-0.2	0.1	0.5	0.5
	6H	2.6	2.9	3.0	3.3	3.7	2.8	3.1	3.2	3.5	3.8	3.8
8H	8H	4.5	4.8	4.9	5.2	5.6	4.6	4.9	5.0	5.3	5.7	5.7
	12H	6.6	6.8	7.0	7.2	7.6	6.6	6.9	7.1	7.3	7.7	7.7
	4H	0.4	0.7	0.8	1.1	1.5	0.7	0.9	1.1	1.3	1.7	1.7
	6H	4.1	4.3	4.5	4.7	5.1	4.2	4.4	4.6	4.8	5.3	5.3
	8H	6.1	6.3	6.5	6.7	7.2	6.1	6.3	6.6	6.8	7.2	7.2
12H	12H	8.3	8.4	8.8	8.9	9.4	8.4	8.5	8.8	9.0	9.5	9.5
	4H	0.9	1.1	1.3	1.5	2.0	1.1	1.3	1.5	1.7	2.2	2.2
	6H	4.6	4.8	5.1	5.2	5.7	4.7	4.9	5.2	5.3	5.8	5.8
	8H	6.7	6.8	7.2	7.3	7.8	6.8	6.9	7.2	7.4	7.9	7.9
	Variation of the observer position for the luminaire distances S											
S = 1.0H		+0.5 / -0.3					+0.6 / -0.3					
S = 1.5H		+1.1 / -0.5					+1.3 / -0.5					
S = 2.0H		+1.9 / -0.8					+2.3 / -0.8					
Standard table Correction Summand		---					---					
Corrected Glare Indices referring to 380lm Total Luminous Flux												

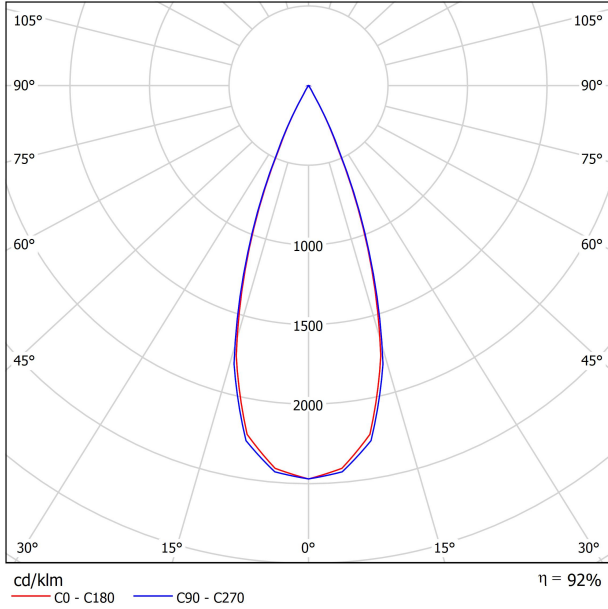
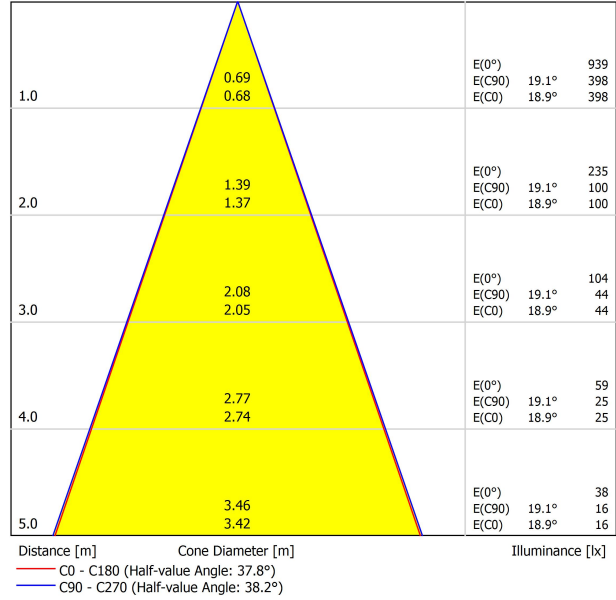
L

<b>BLACK FOSTER Custom</b>	<b>Gap Corner 90°</b>	<b>A317-00-07-   N  </b>	200 x 200mm
	<b>Gap 250</b>	<b>A317-00-01-   N  </b>	250mm
	<b>Gap 500</b>	<b>A317-00-02-   N  </b>	500mm
	<b>Gap 1000</b>	<b>A317-00-03-   N  </b>	1000mm
	<b>Gap 2000</b>	<b>A317-00-04-   N  </b>	2000mm

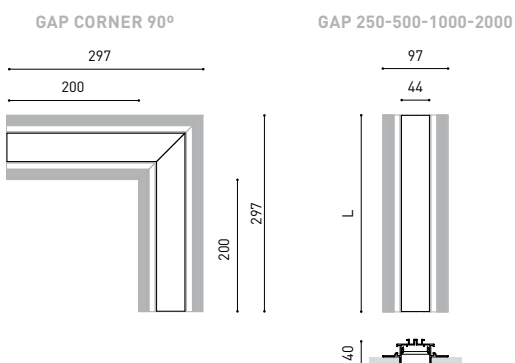

<b>BLACK FOSTER End Caps Kit</b>	<b>A317-00-05-   N  </b>	Thickness of each cover 2mm.
----------------------------------	--------------------------	------------------------------



<b>BLACK FOSTER Straight Joiner</b>	<b>A317-00-06</b>	
-------------------------------------	-------------------	--



COLOUR | **N ■ RAL 9005** | MATERIAL | AL | ABS+PC |

**BLACK FOSTER Track Clamp Kit**

A219-21-20- | B |



**BLACK FOSTER Flush Ceiling Kit**

A219-22-06- | B |



**BLACK FOSTER Track Clamp Kit for M6 ROD**

A219-21-21- | B |



**BLACK FOSTER Suspension Kit**

A219-21-10- | B |

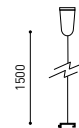

**SUGGESTED MOUNTING ACCESSORIES QUANTITIES**

Black Foster custom 2, 3, 5: 1Pcs.

Black Foster custom 10, 15: 2Pcs.



Gap 250, 500, 1000: 2Pcs.

Gap 2000: 4Pcs.

COLOUR | B □ |



#### DRIVER OPTIONS\*

		P	I	D
 NO DIM	<b>0434-01-18</b>	50W	700mA	124 x 79 x 22mm
 DALI   Push / 1-10V	<b>0433-00-23</b>	50W	700mA	124 x 79 x 22mm

Connect in series only in order to keep a constant current.



Fuente de luz (LED) reemplazable por un profesional autorizado  
 Replaceable (LED only) light source by an authorized professional.  
 Source lumineuse (LED) remplaçable par un professionnel agréé  
 Sorgente luminosa (LED) sostituibile da parte di un professionista autorizzato  
 Austauschbare (LED) Lichtquelle durch einen autorisierten Fachmann



Equipo de control reemplazable por un profesional autorizado  
 Replaceable control gear by an authorized professional  
 Dispositif de commande remplaçable par un professionnel agréé  
 Alimentatore sostituibile da parte di un professionista autorizzato  
 Auswechselbares Betriebsgerät durch autorisierten Fachmann

INSTRUCCIONES PARA EL FINAL DE VIDA Y LA ELIMINACIÓN LOS COMPONENTES  
 INSTRUCTIONS ON END-OF-LIFE AND COMPONENT DISPOSAL  
 INSTRUCTIONS POUR LA GESTION DES COMPOSANTS EN FIN DE VIE ET LEUR MISE AU REBUT  
 ISTRUZIONI PER IL FINE VITA E LO SMALTIMENTO DEI COMPONENTI  
 ANWEISUNGEN ZUR ENTSORGUNG DER LEUCHTENKOMPONENTEN



Interrumpir la alimentación del aparato  
 Cut the power supply to the luminaire  
 Couper l'alimentation du luminaire  
 Interrompere l'alimentazione dell'apparecchio  
 Stromversorgung der Leuchte unterbrechen



Quitar la(s) fuente(s) de luz para el desecho  
 Remove light source(s) for disposal  
 Retirer la (les) source(s) lumineuse(s) pour l'élimination  
 Rimuovere la/le sorgente/e di luce per lo smaltimento  
 Lichtquelle(n) zur Entsorgung entfernen



Quitar la batería para el desecho  
 Remove the battery for decommissioning  
 Retirer la batterie pour sa mise au rebut  
 Rimuovere la batteria per la dismissione  
 Die Batterie ordnungsgemäß entsorgen



Quitar el equipo de control para el desecho  
 Remove control gear for disposal  
 Retirer le dispositif de commande pour l'élimination  
 Rimuovere l'alimentatore per lo smaltimento  
 Betriebsgerät zur Entsorgung ausbauen

Enviar los materiales a un centro de recogida RAEE  
 Send the materials to a WEEE collection centre  
 Envoyer les matériaux dans une déchetterie DEEE  
 Inviare i materiali ad un centro di raccolta RAEE  
 Die Materialien in einem WEEE-Zentrum entsorgen

