

DC Square-body Fuses Sizes 600 - 602 - 2x602 gR Brackets size 600 - 3500 to 4000 V DC

gRB-gRD from 6 to 125 A

Dimensions

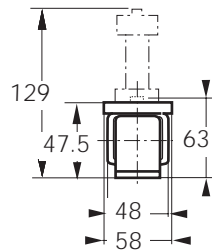
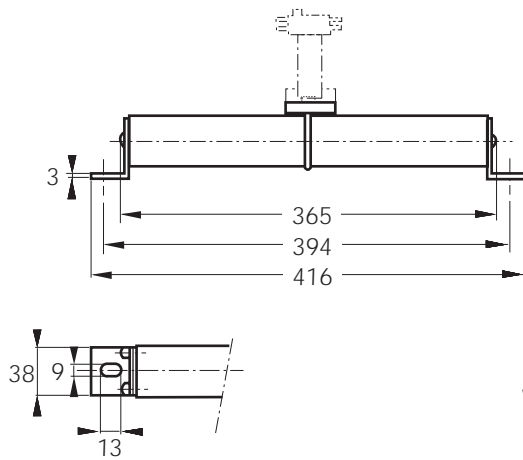

Weight: 1920 g

Main Characteristics

Size	Current rating I_N (A)	Breaking Capacity	Watts loss		Designation	Ref. Number	Catalog Number
			$0.8 I_N$ (W)	I_N (W)			
600	6	@ 3500 V DC 30 kA L/R = 30 ms	5.3	9.5	CC 35 gRB 600 QF 0006	S083736	D600GB35C6QF
	8		7	12.7	CC 35 gRB 600 QF 0008	R083735	D600GB35C8QF
	10		10.2	18.5	CC 35 gRB 600 QF 0010	N089390	D600GB35C10QF
	12		11	20	CC 35 gRB 600 QF 0012	V082220	D600GB35C12QF
	16		13.1	24	CC 35 gRB 600 QF 0016	P089391	D600GB35C16QF
	20		14	25.4	CC 35 gRB 600 QF 0020	Q089392	D600GB35C20QF
	25		18	32.5	CC 35 gRB 600 QF 0025	R089393	D600GB35C25QF
	32	@ 4000 V DC 30 kA L/R = 30 ms	25.5	46	CC 40 gRB 600 QF 0032	A086963	D600GB40C32QF
	40	35	63	CC 40 gRB 600 QF 0040	B086964	D600GB40C40QF	
	50	29	52	CC 40 gRB 600 QF 0050	C086965	D600GB40C50QF	
	63	42	76.5	CC 40 gRB 600 QF 0063	D086966	D600GB40C63QF	
	80	51	92	CC 40 gRB 600 QF 0080	E086967	D600GB40C80QF	
	80	@ 4000 V DC 30 kA L/R = 15 ms	39	67	CC 40 gRD 600 QF 0080	B075763	D600GD40C80QF
	100	50.5	88	CC 40 gRD 600 QF 0100	C075764	D600GD40C100QF	
	125	63	110	CC 40 gRD 600 QF 0125	D075765	D600GD40C125QF	

Pack: 1 piece

Microswitch MC 2R 3E 1-5NBS Ref. Number: J310025



DC Square-body Fuses

Sizes 600 - 602 - 2x602

gR Brackets size 600 - 3500 to 4000 V DC



gRB-gRD from 6 to 125 A

Electrical characteristics

DC applications data

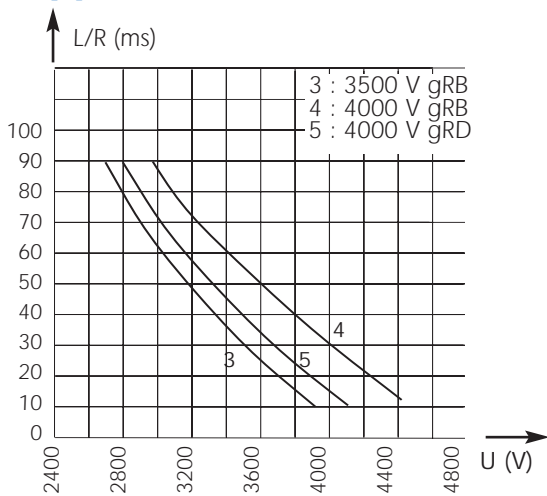

Above: Curves indicate maximum permissible value of time constant L/R as a function of DC working voltage

Max. AC voltage (50/60 Hz):

3600 V with breaking capacity of 30 kA

Peak arc voltage vs. working voltage

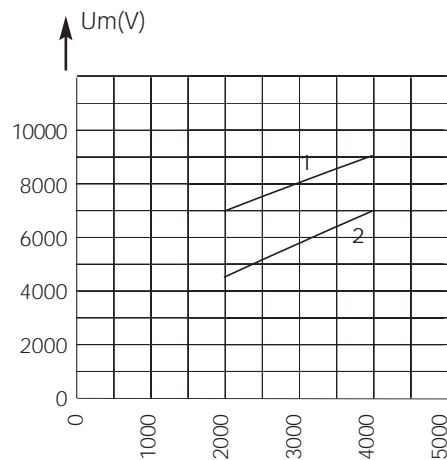

1: $L/R = 30 \text{ ms-3500-4000 V gRB}$

2: $L/R = 15 \text{ ms 4000 V gRD}$

Above: Curves indicate for various time constants L/R the peak arc voltage which may appear across fuse terminals, vs. DC working voltage

Time vs. current characteristics

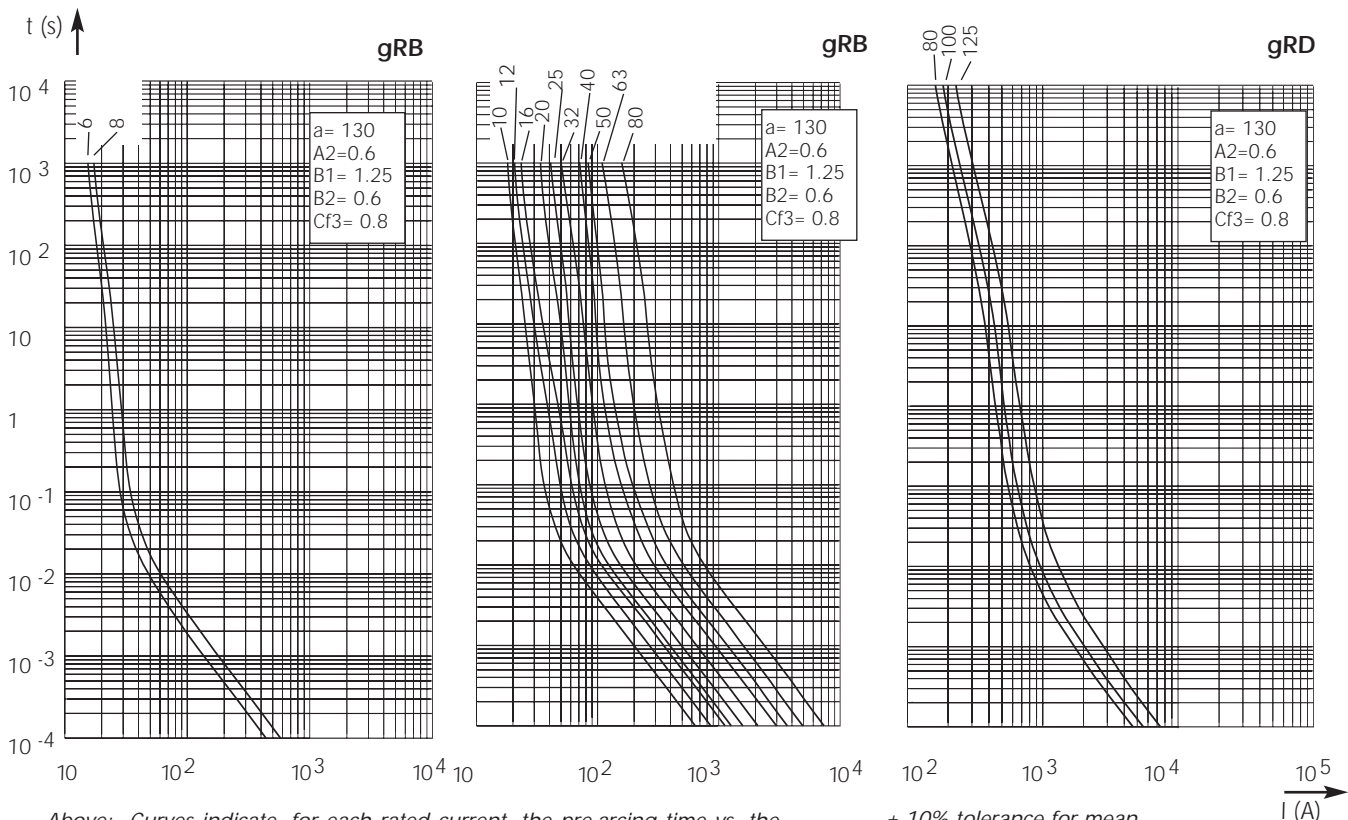

Above: Curves indicate, for each rated current, the pre-arcing time vs. the R.M.S. pre-arcing current.

$\pm 10\%$ tolerance for mean pre-arcing current



DC Square-body Fuses Sizes 600 - 602 - 2x602 gR Blades size 600 - 3500 to 4000 V DC

gRB from 10 to 80 A

Dimensions

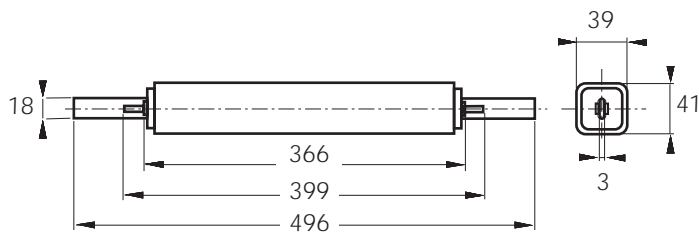

Weight: 1424 g

Main Characteristics

Size	Current rating I_N (A)	Breaking Capacity	Watts loss		Designation	Ref. Number	Catalog Number
			$0.8 I_N$ (W)	I_N (W)			
600	10	@ 3500 V DC 30 kA L/R = 30 ms	10.2	18.5	CC 35000 CV3 gRB 600 PSP 10	K088145	D 600 GB 35 C10 P
	12		11	20	CC 35000 CV3 gRB 600 PSP 12	T081023	D 600 GB 35 C12 P
	16		13.1	24	CC 35000 CV3 gRB 600 PSP 16	D086989	D 600 GB 35 C16 P
	20		14	25.4	CC 35000 CV3 gRB 600 PSP 20	N087481	D 600 GB 35 C20 P
	25		18	32.5	CC 35000 CV3 gRB 600 PSP 25	E086783	D 600 GB 35 C25 P
	32	@ 4000 V DC 30 kA L/R = 30 ms	25.5	46	CC 40000 CV3 gRB 600 PSP 32	A086986	D 600 GB 40 C32 P
	40		35	63	CC 40000 CV3 gRB 600 PSP 40	Z086985	D 600 GB 40 C40 P
	50		29	52	CC 40000 CV3 gRB 600 PSP 50	Y086984	D 600 GB 40 C50 P
	63		42	76.5	CC 40000 CV3 gRB 600 PSP 63	X086983	D 600 GB 40 C63 P
	80		51	92	CC 40000 CV3 gRB 600 PSP 80	W086982	D 600 GB 40 C80 P

Pack: 1 piece



DC Square-body Fuses

Sizes 600 - 602 - 2x602

gR Blades size 600 - 3500 to 4000 V DC

gRB-gRD from 10 to 80 A

Electrical characteristics

DC applications data

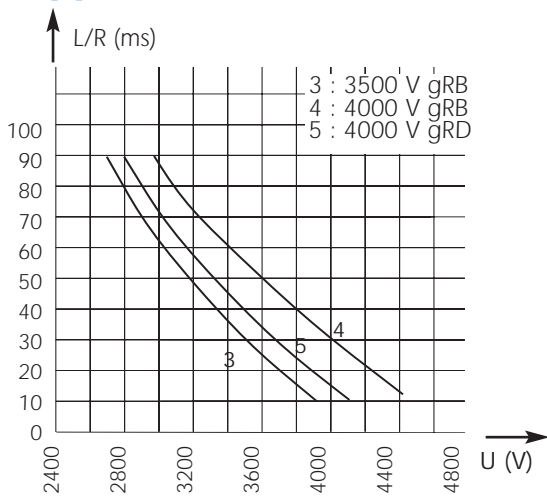

Above: Curves indicate maximum permissible value of time constant L/R as a function of DC working voltage

Max. AC voltage (50/60 Hz):

3600 V with breaking capacity of 30 kA

Peak arc voltage vs. working voltage

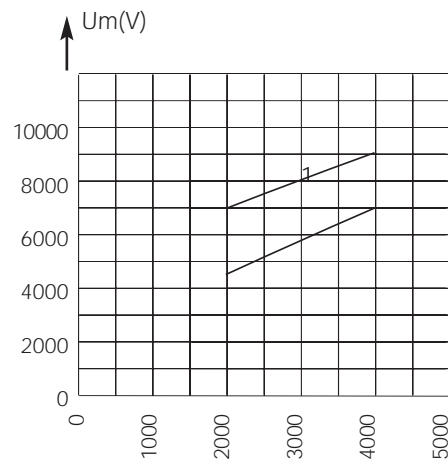

1: $L/R = 30 \text{ ms-3500-4000 V gRB}$

2: $L/R = 15 \text{ ms 4000 V gRD}$

Above: Curves indicate for various time constants L/R the peak arc voltage which may appear across fuse terminals, vs. DC working voltage

Time vs. current characteristics

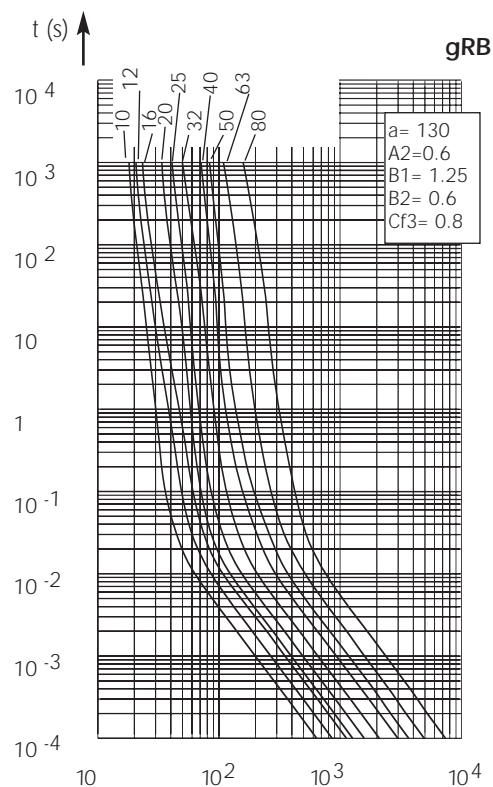

$\pm 8\%$ tolerance for mean pre-arcing current

Above: Curves indicate, for each rated current, the pre-arcing time vs. the R.M.S. pre-arcing current.