



Product designation

Product type designation

Mechanical features

Weight

g 64

Dimensions

Rigid connecting kits for star-delta starter. For BF26...BF38 BFX3231

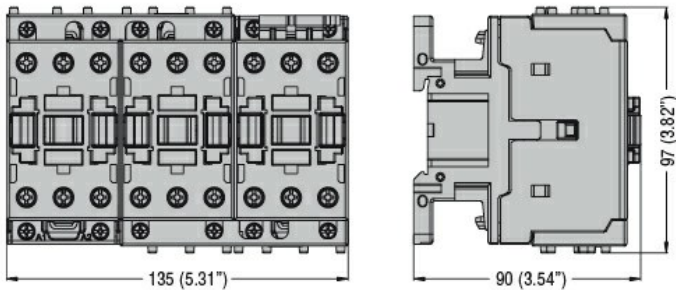

Wiring diagrams

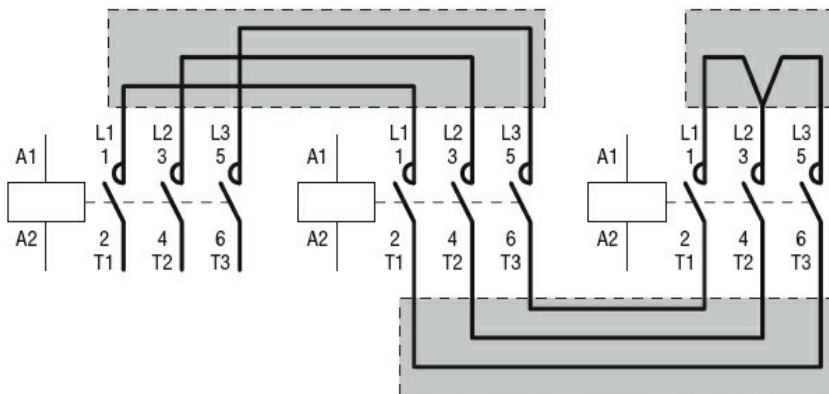

Certifications and compliance

Compliance

CSA C22.2 n° 60947-1

IEC/EN 60947-1

UL 60947-1

Certificates

cULus

EAC

ETIM classification

ETIM 8.0

EC002498 -  
Accessories/spare  
parts for low-  
voltage switch  
technology