

Part number

CX 02 4BM



Male modular insert, Mixo series, screw terminal connection, 2 poles, 1 module, 40 A 1000 V 8 kV 3

Product description		Material properties	
Product type	Modular insert	Main material	Polycarbonate
Series	Mixo	Colour	RAL 7032 grey
Connection type	Screw terminal connection		Compliant with exemption 6(c): copper alloy containing up to 4% lead by weight
Gender	Male	RoHs conformity	
N. of poles	2 poles	China RoHs - EFUP	50
Size	1 module	REACH SVHC substances	Yes Lead
Technical data		SCIP number	1a9c93ff-0445-4a16-81e3-1609ac5274d6
Current	40 A	Approvals / Standards	
Voltage	1000 V	Reference standard	EN 61984:2009-06
Rated impulse withstand voltage	8 kV	Certifications	CSA, CQC, DNV, BV, EAC
Pollution degree	3	UL	ECBT2
Rated voltage according to UL/CSA	600 V	cUL	ECBT8
Wire cross-section	6,00 mm ² - 10,00 mm ²	General ordering information	
AWG size	10 - 8	EAN13 code	8015747048194
Contact type	Turned silver plated	eCl@ss 8.1	27440205
IP degree of protection	IP20 without enclosure, IP65/IP66/IP68/IP69 with enclosure	ETIM 7.0	EC000438
Further technical details		Packaging Information	
Characteristics according to EN 61984	40A 1000V 8kV 3	Packaging length	180,00 mm
Insulation resistance	≥ 10 GΩ	Packaging height	120,00 mm
Contact resistance	≤ 0,5 mΩ	Packaging width	155,00 mm
Weight	25,00 g	Packaging weight	1,68 kg
Operating temperature range (min, max)	-40 °C ... +125 °C	Packaging volume	3,35 dm ³
UL 94 flammability rating	V-0	Packaging description	Carton box
		Packaging quantity	60 Pcs
		Packaging EAN code	8015747221139
		Sub-packaging length	35,00 mm
		Sub-packaging height	40,00 mm
		Sub-packaging width	155,00 mm
		Sub-packaging weight	0,28 kg
		Sub-packaging volume	0,22 dm ³
		Sub-packaging description	Carton tray
		Sub-packaging quantity	10 Pcs
		Sub-packaging EAN barcode	8015747143684

Part number

CX 02 4BM



Catalogue drawings

Catalogue drawings

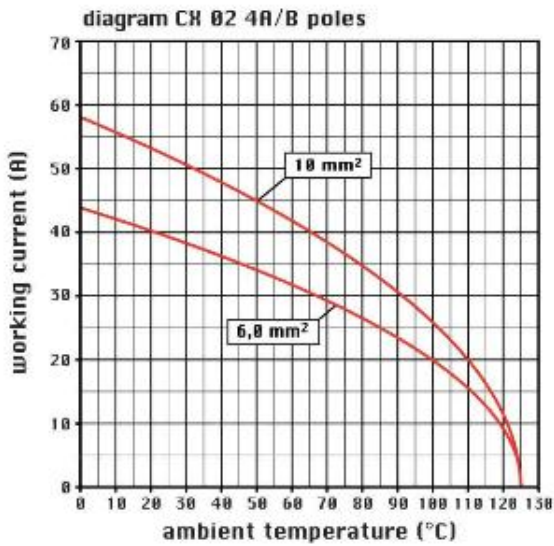

CX 02 4BM

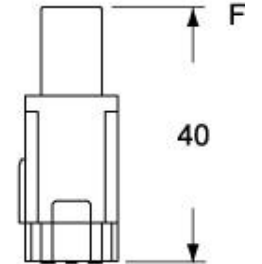
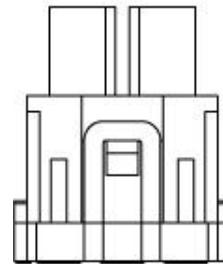
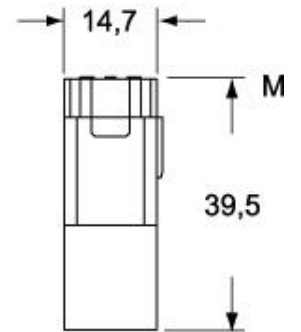
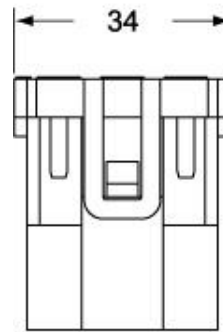

CX 02 4BF

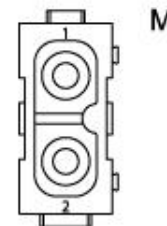
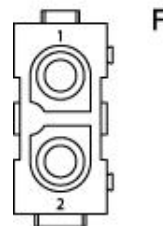

Notes

Standard modular inserts:
-in combination with standard contacts and standard frames (CX ... TF/TM); must be mounted either in traditional enclosures or in COB panel supports (both up to 500 matings).

Dimensions shown in mm are not binding and may be changed without notice.

California Proposition 65 Information



WARNING

This product can expose you to lead and its compounds, known to the State of California to cause cancer and/or reproductive toxicity. For more information go to www.P65Warnings.ca.gov.
