



Product designation				Power contactor
Product type designation				BF80
<b>Contact characteristics</b>				
Number of poles	Nr.			4
Rated insulation voltage $U_i$ IEC/EN	V			1000
Rated impulse withstand voltage $U_{imp}$	kV			8
Operational frequency	min	Hz	25	
	max	Hz	400	
IEC Conventional free air thermal current $I_{th}$	A			115
Operational current $I_e$	AC-1 ( $\leq 40^\circ\text{C}$ )	A	115	
	AC-1 ( $\leq 55^\circ\text{C}$ )	A	95	
	AC-1 ( $\leq 70^\circ\text{C}$ )	A	80	
	AC-3 ( $\leq 440\text{V} \leq 55^\circ\text{C}$ )	A	80	
	AC-4 (400V)	A	38	
Rated operational current AC-3 ( $T \leq 55^\circ\text{C}$ )	230V	A	80	
	400V	A	80	
	415V	A	80	
	440V	A	80	
	500V	A	78	
	690V	A	57	
	1000V	A	28	
Rated operational power AC-1 ( $T \leq 40^\circ\text{C}$ )	230V	kW	43	
	400V	kW	76	
	500V	kW	95	
	690V	kW	120	
IEC max current $I_e$ in DC1 with $L/R \leq 1\text{ms}$ with 1 poles in series	$\leq 24\text{V}$	A	70	
	48V	A	60	
	75V	A	60	
	110V	A	8	
	220V	A	-	
IEC max current $I_e$ in DC1 with $L/R \leq 1\text{ms}$ with 2 poles in series	$\leq 24\text{V}$	A	100	
	48V	A	100	
	75V	A	100	
	110V	A	80	
	220V	A	9	
IEC max current $I_e$ in DC1 with $L/R \leq 1\text{ms}$ with 3 poles in series	$\leq 24\text{V}$	A	100	
	48V	A	100	
	75V	A	100	

	110V	A	85
	220V	A	95
<hr/>			
IEC max current I <sub>e</sub> in DC1 with L/R ≤ 1ms with 4 poles in series			
	≤24V	A	100
	48V	A	100
	75V	A	100
	110V	A	100
	220V	A	115
<hr/>			
IEC max current I <sub>e</sub> in DC3-DC5 with L/R ≤ 15ms with 1 poles in series			
	≤24V	A	40
	48V	A	30
	75V	A	30
	110V	A	3
	220V	A	–
<hr/>			
IEC max current I <sub>e</sub> in DC3-DC5 with L/R ≤ 15ms with 2 poles in series			
	≤24V	A	60
	48V	A	50
	75V	A	50
	110V	A	40
	220V	A	5
<hr/>			
IEC max current I <sub>e</sub> in DC3-DC5 with L/R ≤ 15ms with 3 poles in series			
	≤24V	A	80
	48V	A	70
	75V	A	70
	110V	A	60
	220V	A	64
<hr/>			
IEC max current I <sub>e</sub> in DC3-DC5 with L/R ≤ 15ms with 4 poles in series			
	≤24V	A	90
	48V	A	90
	75V	A	90
	110V	A	75
	220V	A	80
<hr/>			
Short-time allowable current for 10s (IEC/EN60947-1)		A	640
<hr/>			
Protection fuse			
	gG (IEC)	A	125
	aM (IEC)	A	80
<hr/>			
Making capacity (RMS value)		A	800
<hr/>			
Breaking capacity at voltage			
	440V	A	640
	500V	A	625
	690V	A	456
<hr/>			
Resistance per pole (average value)		mΩ	0.6
<hr/>			
Power dissipation per pole (average value)			
	I <sub>th</sub>	W	7.9
	AC-3	W	3.8
<hr/>			
Tightening torque for terminals			
	min	Nm	4
	max	Nm	5
	min	I <sub>bin</sub>	2.95
	max	I <sub>bin</sub>	3.69
<hr/>			
Tightening torque for coil terminal			
	min	Nm	0.8
	max	Nm	1

	min	lbin	0.8
	max	lbin	0.74
Max number of wires simultaneously connectable		Nr.	2
Conductor section			
AWG/Kcmil			
	max		2
Flexible w/o lug conductor section			
	min	mm <sup>2</sup>	1.5
	max	mm <sup>2</sup>	35
Flexible c/w lug conductor section			
	min	mm <sup>2</sup>	1.5
	max	mm <sup>2</sup>	35
Power terminal protection according to IEC/EN 60529			IP20 front
<b>Mechanical features</b>			
Operating position	normal allowable		Vertical plan ±30°
Fixing			Screw / DIN rail 35mm
Weight		g	1240
Conductor section			
AWG/kcmil conductor section			
	max		2
<b>Operations</b>			
Mechanical life		cycles	15000000
Electrical life		cycles	1300000
<b>Safety related data</b>			
Performance level B10d according to EN/ISO 13489-1			
	rated load	cycles	1300000
	mechanical load	cycles	15000000
Mirror contacts according to IEC/EN 60947-4-1			yes
EMC compatibility			yes
<b>AC coil operating</b>			
Rated AC voltage at 60Hz		V	220
AC operating voltage			
of 60Hz coil powered at 60Hz			
pick-up	min	%Us	80
	max	%Us	110
drop-out	min	%Us	20
	max	%Us	55
AC average coil consumption at 20°C			
of 60Hz coil powered at 60Hz			
	in-rush	VA	210
	holding	VA	15
Dissipation at holding ≤20°C 50Hz		W	5
<b>Max cycles frequency</b>			
Mechanical operation		cycles/h	3600
<b>Operating times</b>			
Average time for Us control			
in AC			
			Closing NO

		min	ms	12
		max	ms	28
	Opening NO			
		min	ms	8
		max	ms	22
in DC				
	Closing NO			
		min	ms	40
		max	ms	85
	Opening NO			
		min	ms	20
		max	ms	55

**UL technical data**

Full-load current (FLA) for three-phase AC motor

at 480V	A	77
at 600V	A	77

Yielded mechanical performance

for three-phase AC motor

200/208V	HP	25
220/230V	HP	30
460/480V	HP	60
575/600V	HP	75

General USE

Contactor

AC current	A	115
------------	---	-----

Short-circuit protection fuse, 600V

High fault

Short circuit current	kA	100
Fuse rating	A	200
Fuse class		J

Standard fault

Short circuit current	kA	10
Fuse rating	A	200
Fuse class		RK5

**Ambient conditions**

Temperature

Operating temperature

min	°C	-50
max	°C	70

Storage temperature

min	°C	-60
max	°C	80

Max altitude

m	3000
---	------

**Resistance & Protection**

Pollution degree

3

**Dimensions**

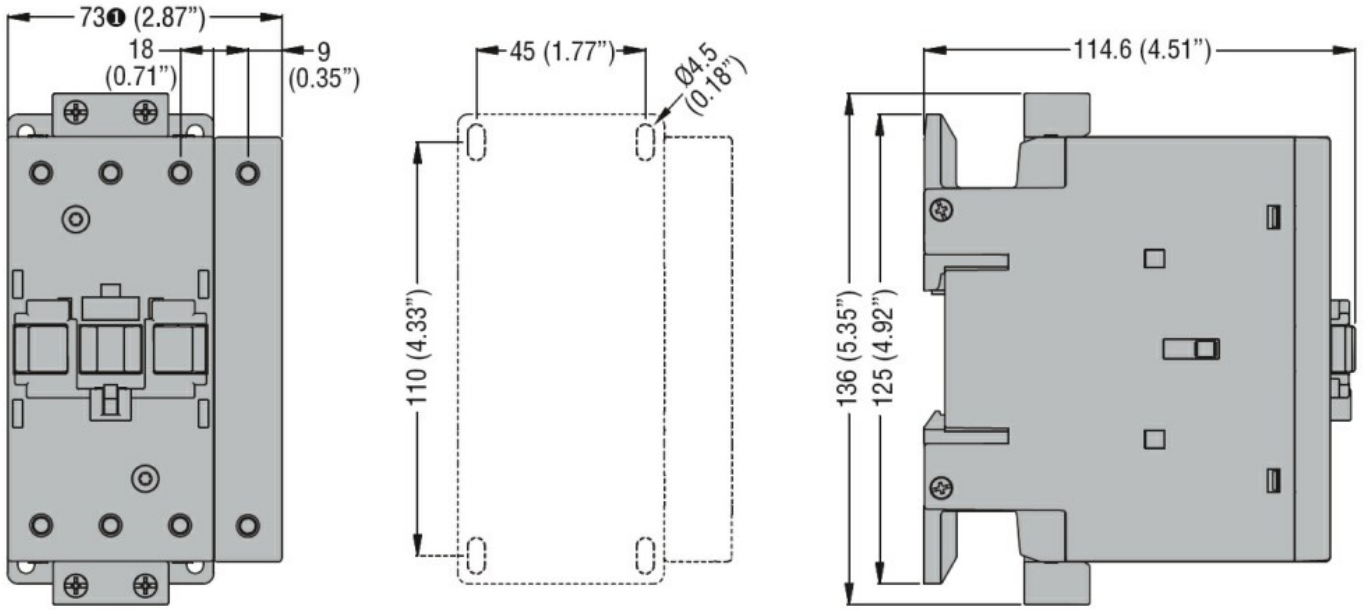

① BF80T2 82mm/3.23"

### Wiring diagrams

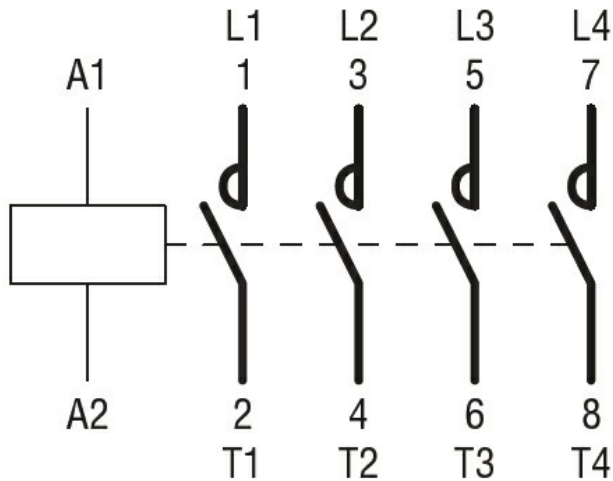

### Certifications and compliance

#### Compliance

CSA C22.2 n° 60947-1

CSA C22.2 n° 60947-4-1

IEC/EN/BS 60947-1

IEC/EN/BS 60947-4-1

UL 60947-1

UL 60947-4-1

#### Certificates

CCC

cULus

### ETIM classification

ETIM 8.0

EC000066 -  
Power contactor,  
AC switching