

FICHE TECHNIQUE PRODUIT

Gainable standard DRV : MMD-UP0271BHP-E



PRESSION DISPONIBLE
MAX.



COMPACTÉ



POMPE DE RELEVAGE
INTÉGRÉE

Gammes DRV	SMMSu	SMMSe	SHRMe	Mini-SMMSe
Compatibilités	✓	✓	✓	✓

Référence		MMD-UP0271BHP-E
Puissance frigorifique (35°C ext./27°C int.)	kW	8,0
Puissance calorifique (+7°C ext./20°C int.)	kW	9,0
Code puissance	CV	3,0
Puissance absorbée	kW	0,135
Intensité	A	0,8
Intensité de démarrage	A	1,2
Débit d'air (GV/PV)	m3/h	1320 / 870
Niveau de pression sonore à 1,5m (GV/MV/PV)	dB(A)	33 / 30 / 27
Dimensions (H x L x P)	mm	275 x 1000 x 750
Poids	kg	30
Pression disponible	Pa	7 niveaux : de 40 (réglage usine) à 150
Plenum de soufflage* (référence / piquages)		TCB-SF80C6BPE / 3x 200 mm
Liaisons frigorifiques (gaz-liquide)	pouce	5/8 - 3/8
Diamètre extérieur des condensats	mm	32
Alimentation électrique	V-ph-Hz	220/240-1-50

* Accessoire

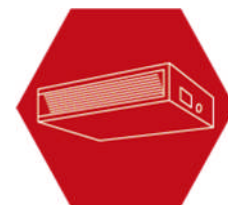

Dimensions :

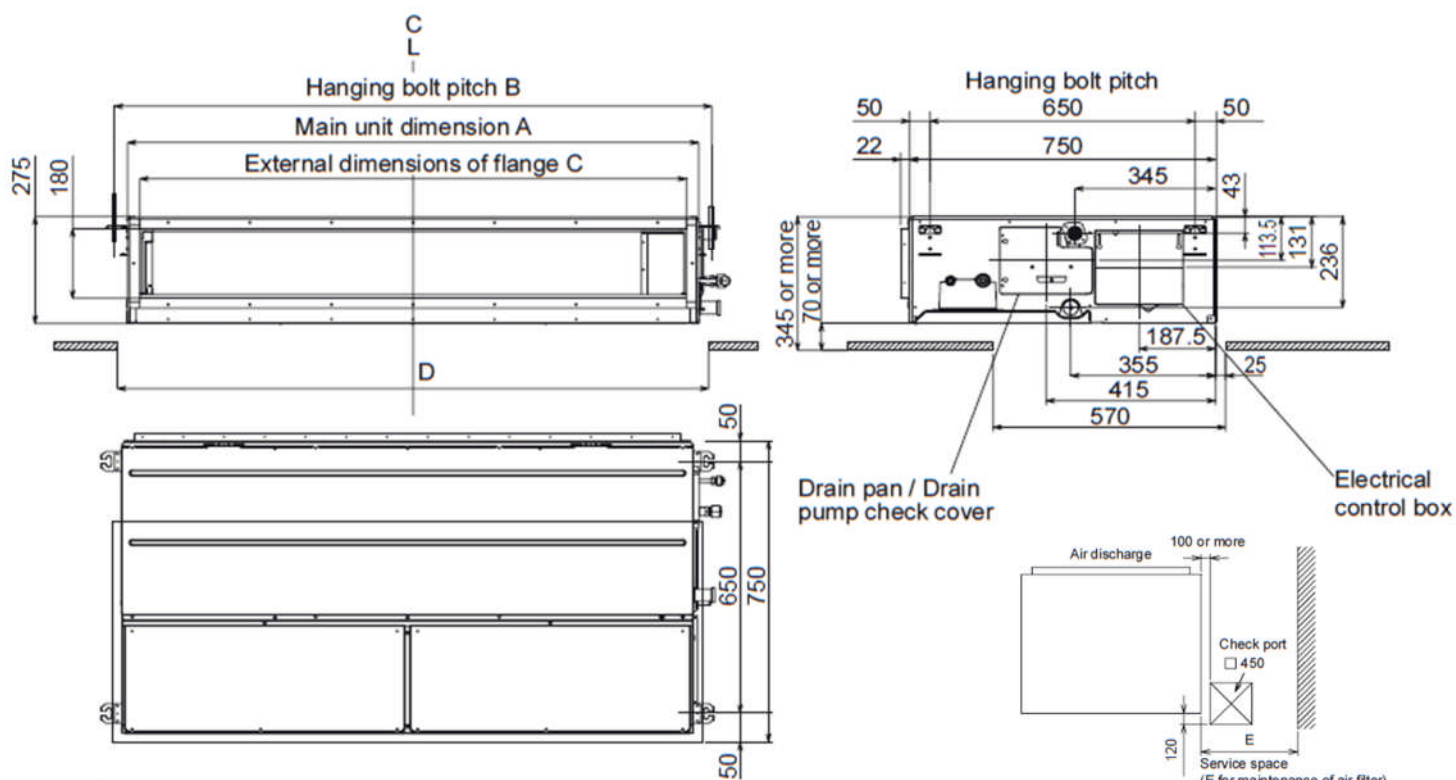

Dimension

	A	B	C	D	E
UP005 ~ 018 type	700	765	640	750	700
UP024 ~ 030 type	1000	1065	940	1050	500
UP036 ~ 056 type	1400	1465	1340	1450	700

For duct design MMD-UP0241* to 0301 type

<Under air intake>

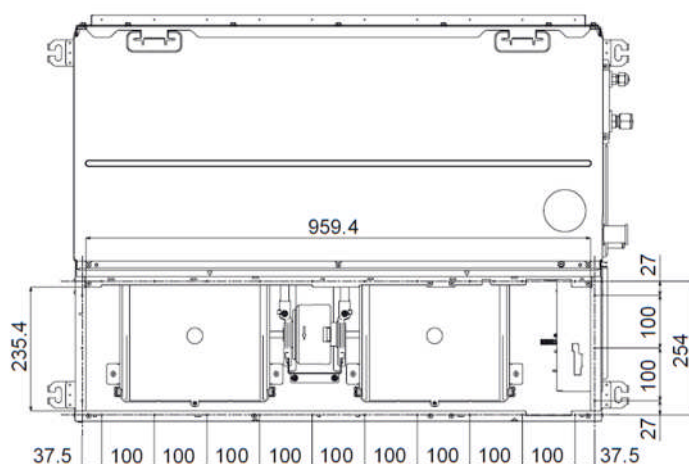

<Back air intake>

