

TeSys™ GV5PB / GV6PB

Motor Protection Circuit Breakers

User Guide

TeSys offers innovative and connected solutions for motor starters.

12/2019



The information provided in this documentation contains general descriptions and/or technical characteristics of the performance of the products contained herein. This documentation is not intended as a substitute for and is not to be used for determining suitability or reliability of these products for specific user applications. It is the duty of any such user or integrator to perform the appropriate and complete risk analysis, evaluation and testing of the products with respect to the relevant specific application or use thereof. Neither Schneider Electric nor any of its affiliates or subsidiaries shall be responsible or liable for misuse of the information contained herein. If you have any suggestions for improvements or amendments or have found errors in this publication, please notify us.

You agree not to reproduce, other than for your own personal, noncommercial use, all or part of this document on any medium whatsoever without permission of Schneider Electric, given in writing. You also agree not to establish any hypertext links to this document or its content. Schneider Electric does not grant any right or license for the personal and noncommercial use of the document or its content, except for a non-exclusive license to consult it on an "as is" basis, at your own risk. All other rights are reserved.

All pertinent state, regional, and local safety regulations must be observed when installing and using this product. For reasons of safety and to help ensure compliance with documented system data, only the manufacturer should perform repairs to components.

When devices are used for applications with technical safety requirements, the relevant instructions must be followed.

Failure to use Schneider Electric software or approved software with our hardware products may result in injury, harm, or improper operating results.

Failure to observe this information can result in injury or equipment damage.

© 2019 Schneider Electric. All rights reserved.

Table of Contents



	Safety Information	5
	About the Book	7
Chapter 1	Introduction	9
	TeSys GV5PB / GV6PB Devices	10
	Device Overview	11
	Environmental Conditions	16
Chapter 2	Operating the Device	19
	Opening, Closing, and Resetting the Device	20
	Testing a Device With Direct Rotary Handle	22
	Locking a Device With Direct Rotary Handle	23
	Testing a Device With Extended Rotary Handle	25
	Locking a Device With Extended Rotary Handle	26
	De-Energizing the Device	28
Chapter 3	Protection Functions	31
	Protection for Motor-Feeders	32
	Motor Operating States	33
	Trip Unit Description	34
	Overload or Thermal Protection (ANSI 49)	36
	Short-Time Protection (ANSI 51)	39
	Instantaneous Protection (ANSI 50)	40
	Phase Unbalance Protection (ANSI 46)	41
Chapter 4	Electrical Auxiliary Devices	43
	Electrical Auxiliary Devices	44
	Indication Contacts	47
	Voltage Trip Releases	49
	SDTAM Thermal Fault Module	50
Appendices	53
Appendix A	Additional Characteristics	55
	Motor-Feeder Protection	56
	Reflex Tripping	58
	Limitation Curves	59
Glossary	65



Important Information

NOTICE

Read these instructions carefully, and look at the equipment to become familiar with the device before trying to install, operate, service, or maintain it. The following special messages may appear throughout this documentation or on the equipment to warn of potential hazards or to call attention to information that clarifies or simplifies a procedure.



The addition of this symbol to a “Danger” or “Warning” safety label indicates that an electrical hazard exists which will result in personal injury if the instructions are not followed.



This is the safety alert symbol. It is used to alert you to potential personal injury hazards. Obey all safety messages that follow this symbol to avoid possible injury or death.

DANGER

DANGER indicates a hazardous situation which, if not avoided, **will result in** death or serious injury.

WARNING

WARNING indicates a hazardous situation which, if not avoided, **could result in** death or serious injury.

CAUTION

CAUTION indicates a hazardous situation which, if not avoided, **could result in** minor or moderate injury.

NOTICE

NOTICE is used to address practices not related to physical injury.

PLEASE NOTE

Electrical equipment should be installed, operated, serviced, and maintained only by qualified personnel. No responsibility is assumed by Schneider Electric for any consequences arising out of the use of this material.

A qualified person is one who has skills and knowledge related to the construction and operation of electrical equipment and its installation, and has received safety training to recognize and avoid the hazards involved.

About the Book



At a Glance

Document Scope

This guide provides users, installers, and maintenance personnel with technical information needed to operate TeSys™ GV5PB and TeSys™ GV6PB Motor Protection Circuit Breakers in compliance with UL/CSA standards.

In this guide, the term *device* refers to motor protection circuit breakers.

Validity Note

This document applies to TeSys GV5PB devices and TeSys GV6PB devices.

Online Information

The information contained in this guide is likely to be updated at any time. Schneider Electric strongly recommends that you have the most recent and up-to-date version available on www.se.com/tesys.

The technical characteristics of the devices described in the present document also appear online. To access the information online:

Step	Action
1	Go to the Schneider Electric home page www.se.com .
2	In the Search box type the reference of a product or the name of a product range. <ul style="list-style-type: none">• Do not include blank spaces in the reference or product range.• To get information on grouping similar modules, use asterisks (*).
3	If you entered a reference, go to the Product Datasheets search results and click on the reference that interests you. If you entered the name of a product range, go to the Product Ranges search results and click on the product range that interests you.
4	If more than one reference appears in the Products search results, click on the reference that interests you.
5	Depending on the size of your screen, you may need to scroll down to see the datasheet.
6	To save or print a datasheet as a .pdf file, click Download XXX product datasheet .

The characteristics that are presented in the present document should be the same as those characteristics that appear online. In line with our policy of constant improvement, we may revise content over time to improve clarity and accuracy. If you see a difference between the document and online information, use the online information as your reference.

Related Documents

Title of documentation	Reference number
<i>TeSys GV5PB/GV6PB Motor Protection Circuit Breakers</i>	8536CT1901
<i>TeSys GV5PB - Motor Protection Circuit Breaker - Instruction Sheet</i>	GDE34192
<i>TeSys GV6PB - Motor Protection Circuit Breaker - Instruction Sheet</i>	GDE34193

You can download these technical publications and other technical information from our website at www.se.com.

Trademark Notice

Schneider Electric and TeSys are trademarks and the property of Schneider Electric, its subsidiaries, and affiliated companies. All other trademarks are the property of their respective owners.

Chapter 1

Introduction

What Is in This Chapter?

This chapter contains the following topics:

Topic	Page
TeSys GV5PB / GV6PB Devices	10
Device Overview	11
Environmental Conditions	16

TeSys GV5PB / GV6PB Devices

TeSys Master Range

TeSys is an innovative motor control and management solution from the global market leader. TeSys offers connected, efficient products and solutions for switching and protection of motors and electrical loads in compliance with all major global electrical standards.

Description

TeSys GV5PB / GV6PB devices offer current ratings from 58 to 520 A, for AC power systems up to 600 Vac.

TeSys GV5PB / GV6PB devices are available in the following current ratings:

- TeSys GV5PB for current ratings from 58 to 217 A
- TeSys GV6PB for current ratings from 190 to 520 A

TeSys GV5PB / GV6PB devices have the following features:

- Toggle switch handle
- 3-pole devices
- 5, 10 and 20 trip classes
- The following accessories are optional and installable on site:
 - Voltage trip releases
 - Auxiliary contacts
 - Insulation accessories
 - Mechanical lugs

Device Identification

The commercial reference of each device provides information about:

- The size of the device
- The type of protection the device provides
- The current rating of the device
- The breaking capacity of the device

For example, the commercial reference of the GV5PB 150N device contains the following information:

- GV5: The device is a TeSys GV5 device.
- PB: The device offers line and overload protection.
- 150: The device has a current rating of 150 A.¹
- N: The breaking capacity of the device is 35 kA at 480 Vac.

Short-circuit Current Ratings

The following table shows the short-circuit current rating in kA rms for TeSys GV5PB / GV6PB devices:

Reference	Dial Range	Short-Circuit Current Rating		
		240 VAC	480 VAC	600 VAC
GV5PB150N	58–130	65 kA	35 kA	18 kA
GV5PB150S	58–130	100 kA	65 kA	25 kA
GV5PB250N	114–217	65 kA	35 kA	18 kA
GV5PB250S	114–217	100 kA	65 kA	25 kA
GV6PB400N	190–348	65 kA	35 kA	18 kA
GV6PB400S	190–348	100 kA	65 kA	25 kA
GV6PB600N	312–520	65 kA	35 kA	18 kA
GV6PB600S	312–520	100 kA	65 kA	25 kA

Standard Compliance

TeSys GV5PB / GV6PB devices are compliant with the following standards:

- UL 489 Supplement SH for circuit breakers
- CSA
- NOM

1. The standard device provides 80% rating. 100% rating can be achieved by replacing the aluminum lugs with copper lugs.

Device Overview

Device Description

TeSys GV5PB / GV6PB devices are equipped with toggle switch handles as standard.

The device operating controls, operation indicators, settings, and locking mechanisms are located on the front of the device.

Optional rotary handles are available in black or yellow. See *Devices with Rotary Handle* on page 12.

TeSys GV5PB device

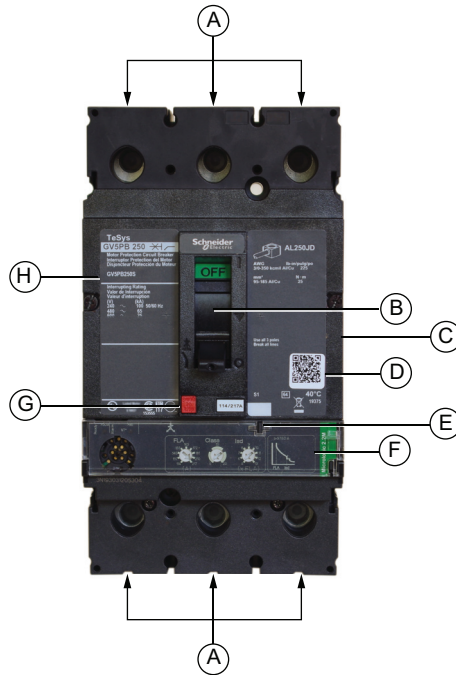

- A Power connection
- B Toggle switch
- C Device and accessory data labels
- D QR code
- E Seal for trip unit
- F Trip unit
- G Push-to-trip button
- H Rating plate

QR code

Scan the QR code to get additional information about the device from the Schneider Electric website. To scan the QR code, use a smart phone that is equipped with a camera and installed with a QR code reader.

Devices with Rotary Handle

For devices with a rotary handle:

- The device operating controls are located on the front enclosure cover.
- The operation indicators and settings are accessible when the door is open.
- The locking mechanisms are located on the front enclosure cover (door closed) (see page 26).

Optional rotary handles are available in two colors:

- Black
- Yellow

NOTE: See instruction sheet [GHD16292AA](#) for information on mounting the extended rotary handle.

Circuit Breaker Face with Rotary Handle (Left) and Extended Rotary Handle (Right)

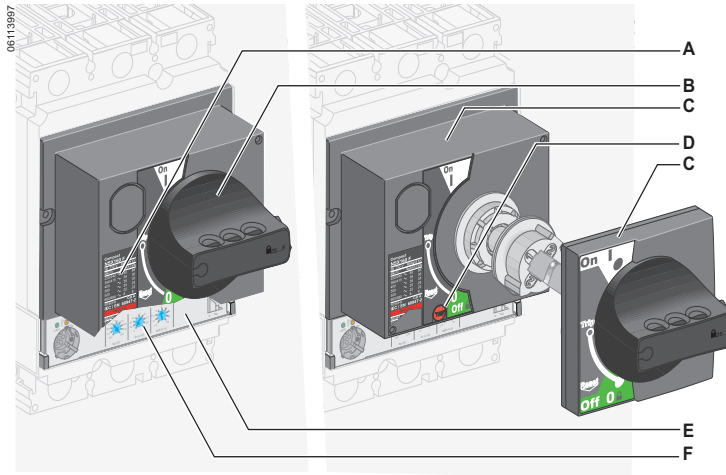

- A Faceplate Label
- B Direct rotary handle
- C Extended rotary handle
- D Push-to-trip button
- E Trip unit
- F Trip unit adjusting dials

Rating Plate

The rating plate on the front of the device identifies the device and its characteristics. The rating plate depends on the breaking performances.

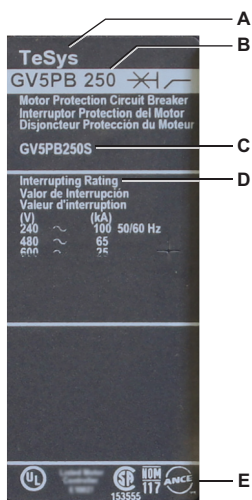

- A Range name
- B Type of device
- C Commercial reference
- D Interrupting rating
- E Standards

TeSys GV5PB Accessories

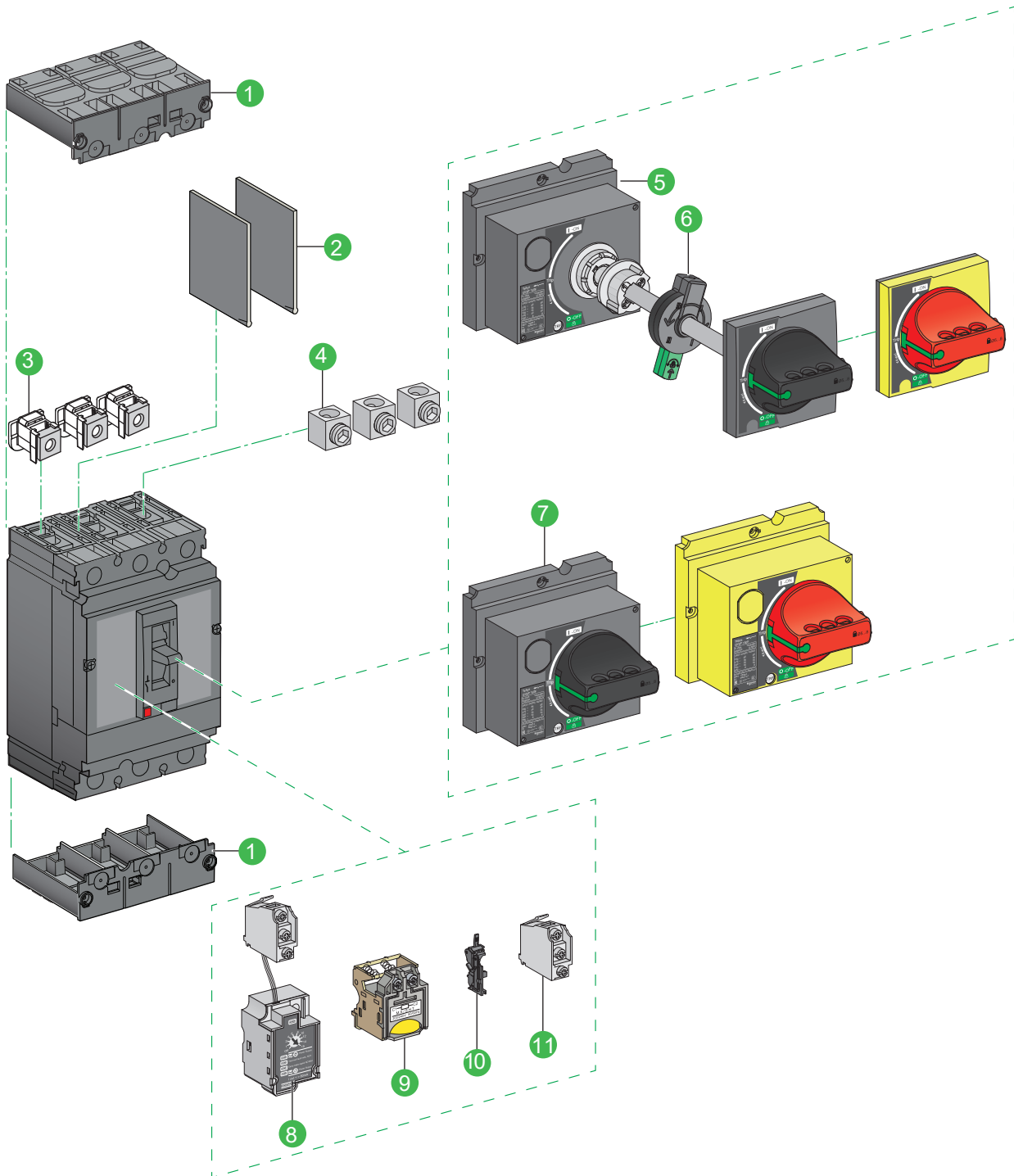

Legend	Accessory	Instruction sheet reference
1	Terminal shield	48940-223-02
2	Phase barrier	48940-254-01
3	Terminal nut insert kit	48940-222-01
4	Mechanical lugs	48940-221-02
5	Extended rotary handle	GHD16292AA
6	Open door shaft operator	EAV78496

Legend	Accessory	Instruction sheet reference
7	Direct rotary handle	MFR55037
8	SDTAM thermal fault module	48940-318-01
9	AU (UVR) or AS (SHT) voltage releases	MFR55033
10	SDE adapter	See Product Data Sheet
11	OF, SD, or SDE indication contacts	MFR55023

TeSys GV6PB Accessories

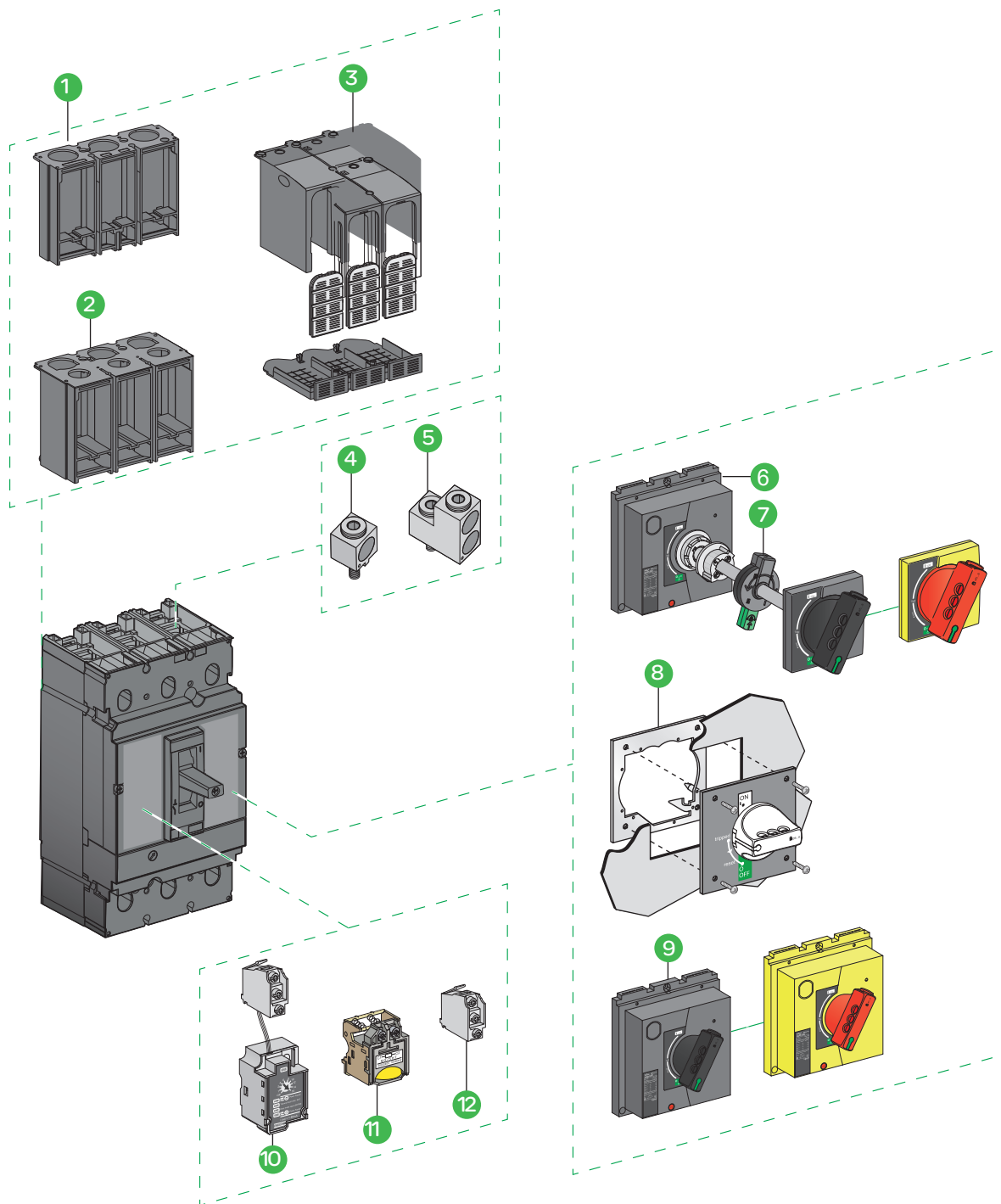

Legend	Accessory	Instruction sheet reference
1	LTSS3P short terminal shield	EAV68909
2	LTSM3P medium terminal shield	EAV68909
3	LTSL3P long terminal shield	EAV68909
4	AL400L61K• / CU400L61K• lug kit	S1A14748
5	L600LS52K• / CU600LS52K• lug kit	S1A14748
6	Extended rotary handle	GHD16292AA

Legend	Accessory	Instruction sheet reference
7	Open door shaft operator	EAV78496
8	MCC Conversion Accessory	GHD16295AA
9	Direct rotary handle	MFR55039
10	SDTAM thermal fault module	48940-318-01
11	AU (UVR) or AS (SHT) voltage releases	MFR55033
12	OF, SD, or SDE indication contacts	MFR55023

Sealing Accessories

Use sealing accessories to prevent device operations.

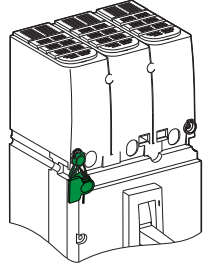
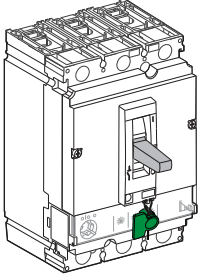
Seal type	Helps to prevent	Seal image
Escutcheon fixing screw	<ul style="list-style-type: none">● Dismantling the escutcheon● Accessing the auxiliaries● Dismantling the trip unit	
Transparent protective cover	<ul style="list-style-type: none">● Altering trip unit settings● Accessing the test port for the trip units	

Environmental Conditions

Ambient Temperature

- GV5PB and GV6PB Motor Protection Circuit Breakers may be used between –13 to +158 °F (–2 to +70 °C). For temperatures higher than 104°F (40°C) inside the enclosure, devices must be derated. See *Temperature Derating* below.
- Circuit breakers should be put into service under normal ambient, operating-temperature conditions.
- The permissible storage temperature range for GV5PB and GV6PB Motor Protection Circuit Breakers in the original packing is –58 to +185 °F (–50 to +85 °C).

Temperature Derating

GV5PB and GV6PB Motor Protection Circuit Breakers are equipped with electronic trip units.

Electronic trip units are not affected by variations in temperature. If the trip units are used in high temperature environments, the Micrologic™ trip unit setting must take into account the temperature limits of the circuit breaker.

Changes in temperature do not affect measurements by electronic trip units.

- The built-in CT sensors with Rogowski coils measure the current.
- The control electronics compare the value of the current to the settings defined for 104 °F (40 °C).

Because temperature has no effect on the CT measurements, the tripping thresholds do not need to be modified.

However, the temperature rise caused by the flow of current combined with the ambient temperature increases the temperature of the device. To avoid reaching the thermal withstand value, it is necessary to limit the current flowing through the device, that is the maximum I_r setting as a function of the temperature.

The table below indicates the maximum long-time (LT) protection setting I_r (A) depending on the ambient temperature.

Type of Device	Rating	Temperature						
		104°F (40°C)	113°F (45°C)	122°F (50°C)	131°F (55°C)	140°F (60°C)	149°F (65°C)	158°F (70°C)
GV5	150 A	No derating						
GV5	250 A	250	250	250	245	237	230	225
GV6	400 A	400	400	400	390	380	370	360
GV6	600 A	600	600	600	585	570	550	535

Extreme Atmospheric Conditions

TeSys GV5PB / GV6PB devices are designed to operate in industrial atmospheres as defined in IEC/EN 60947-2 standard for the highest level of pollution (level 3).

They are tested for extreme storage conditions according to the following standards:

Standard	Title
IEC/EN 60068-2-2	Dry heat, severity level +185 °F (+85 °C)
IEC/EN 60068-2-1	Dry cold, severity level –58 °F (–50 °C)
IEC/EN 60068-2-30	Damp heat, cyclic <ul style="list-style-type: none"> • temperature +131 °F (+55 °C) • relative humidity 95%
IEC/EN 60068-2-52	Salt-mist test

It is recommended to install the device in a properly ventilated switchboard without excessive dust.

Vibration

TeSys GV5PB / GV6PB devices are tested against vibration.

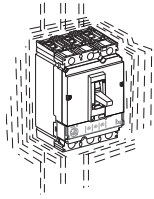

Conformity tests are carried out in accordance with IEC/EN 60068-2-6 standard at the levels required by merchant marine inspection organizations such as Bureau Veritas and Lloyd's Register:

- 2 Hz to 25.0 Hz with an amplitude of +/- 0.063 in (+/- 1.6 mm)
- 25.0 Hz to 100 Hz at an acceleration of +/- 4.0 g

Excessive vibration may cause tripping, breaks in connection, or damage to mechanical parts.

Electromagnetic Disturbances

TeSys GV5PB / GV6PB devices are immune to electromagnetic disturbance.

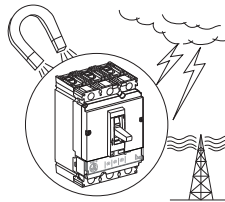

Overcurrent protection tests are carried out in accordance with the electromagnetic compatibility (EMC) standard (IEC/EN 60947-2 standard appendixes F and J).

Check for compliance with EMC standard by testing for immunity to:

- Overvoltages produced by the operation of electromagnetic switchgear.
- Overvoltages produced by atmospheric disturbance that pass through the electrical network (for example, lightning).
- The use of apparatus emitting radio waves (such as radio transmitters, walkie-talkies, or radar).
- Electrostatic discharges produced by the operators themselves.

Conformity with EMC standard as described above helps to ensure that:

- The device operates correctly in a disturbed environment:
 - Without nuisance tripping.
 - In accordance with the trip time.
- There is no disturbance to any type of industrial or commercial environment.

Altitude

TeSys GV5PB / GV6PB devices are designed to operate within specification at altitudes of up to 6,600 ft (2,000 m).

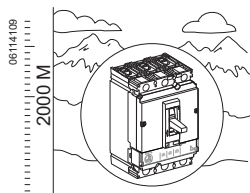

Above 6,600 ft (2,000 m), modifying the characteristics of the surrounding air (dielectric strength, cooling capacity) causes derating as follows:

Altitude (m/ft)	6,560 ft (2,000 m)	9,840 ft (3,000 m)	13,120 ft (4,000 m)	16,400 ft (5,000 m)
Dielectric withstand voltage (V)	3000 V	2500 V	2100 V	1800 V
Insulation voltage (V_i)	800 V	700 V	600 V	500 V
Maximum operational voltage (V_e)	690 V	590 V	520 V	460 V
Average current capacity (A) at 104 °F (40 °C) ($I_n \times$)	10	0.96	0.93	0.9

Chapter 2

Operating the Device

What Is in This Chapter?

This chapter contains the following topics:

Topic	Page
Opening, Closing, and Resetting the Device	20
Testing a Device With Direct Rotary Handle	22
Locking a Device With Direct Rotary Handle	23
Testing a Device With Extended Rotary Handle	25
Locking a Device With Extended Rotary Handle	26
De-Energizing the Device	28

Opening, Closing, and Resetting the Device

Handle Position

The handle position indicates the state of the circuit breaker:

Standard Handle

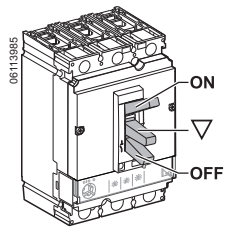

- I (ON): Circuit breaker closed.
Close manually.

- O (OFF): Circuit breaker open.
Open Manually

Rotary Handle

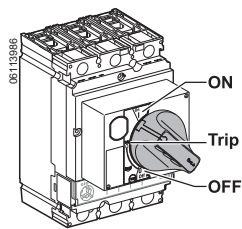

- Trip or Tripped: Circuit breaker tripped.

Tripped by the protection (trip unit or trip auxiliaries), the push-to-trip button, or the UTA tester.

Resetting After a Trip on a Detected Electrical Fault

! WARNING

HAZARD OF CLOSING ON A DETECTED ELECTRICAL FAULT

Do not close the device again without first inspecting and, if necessary, repairing the downstream electrical equipment.

Failure to follow these instructions can result in death, serious injury, or equipment damage.

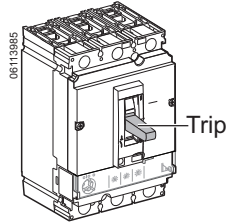

The device has tripped on a detected electrical fault, the toggle switch has moved from the **I (ON)** position to the **Trip** position.

To reset after a trip on a detected electrical fault:

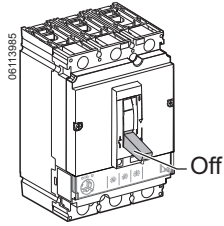
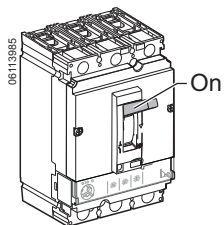
Step	Action	Position	
1	–	Isolate the feed (<i>see page 28</i>) before inspecting the downstream electrical equipment.	Trip
2	–	Look for the cause of the detected fault.	Trip
3	–	Inspect and, if necessary, repair the downstream equipment, using proper safety precautions.	Trip
4	–	Inspect the equipment in the event of a short-circuit trip.	Trip
5		Reset the device by moving the handle from the Trip position to O (OFF) .	O (OFF)
6		Close the device by moving the handle to I (ON) .	I (ON)

NOTE: The fact that a device has tripped does not remedy the cause of the fault detected on the downstream electrical equipment.

Testing the Circuit Breaker

Push-to-Trip Procedure

⚡ ⚠ DANGER

HAZARD OF ELECTRIC SHOCK, EXPLOSION, OR ARC FLASH

When circuit breaker handle is locked OFF (O), always use a properly rated voltage sensing device to confirm power is off before working on equipment.

Failure to follow these instructions will result in death or serious injury.

To check whether the trip mechanism is working correctly, press the push-to-trip button.

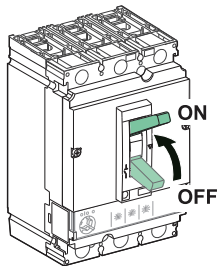
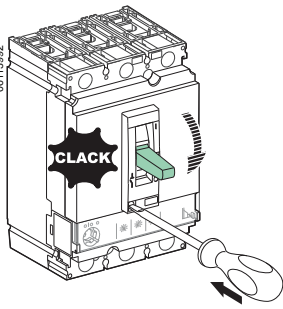
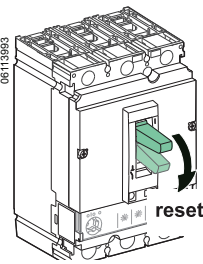
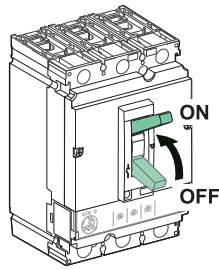
Step	Action	Position
1		Close the circuit breaker. I (ON)
2		Press the push-to-trip button to trip the circuit breaker. ▼
3		Move the handle to the O (OFF) position to reset the circuit breaker. O (OFF)
4		Move the handle to the I (ON) position to close the circuit breaker. I (ON)

Locking the Circuit Breaker

Locking accessories

Use locking accessories to lock the handle in the I (ON) or O (OFF) position.

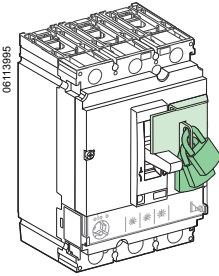
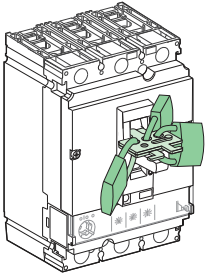
Handle locking		Padlocks
	Accessory that is part of the case	Use up to three padlocks (not supplied), shackle diameter of 0.2–0.3 in. (5–8 mm).
	Accessory that is detachable	Use up to three padlocks (not supplied), shackle diameter of 0.2–0.3 in. (5–8 mm).

NOTE: Locking the handle in the I (**ON**) position does not disable the circuit breaker protection functions. If there is a detected fault, the circuit breaker trips without altering the handle position. When unlocked, the handle moves to the **Trip** position. To return the device to service, follow the resetting instructions ([see page 21](#)).

Door Locking for Rotary Handle

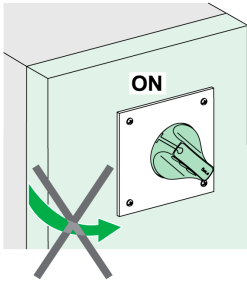

Locks the door in the closed position when the device is in the I (ON) position or in the Trip position.

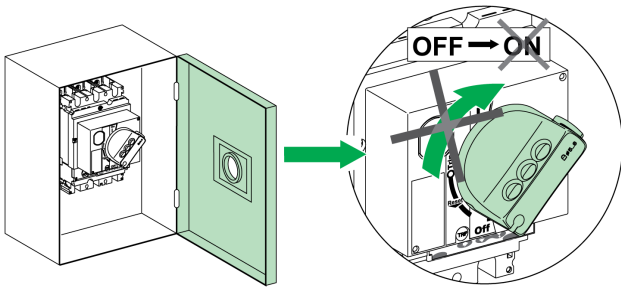

Helps to prevent the direct rotary handle from being moved to the I (ON) position when the door is open.

⚡ ⚠ DANGER

HAZARD OF ELECTRIC SHOCK, EXPLOSION, OR ARC FLASH

Only qualified persons are authorized to disable the door lock.

Failure to follow these instructions will result in death or serious injury.

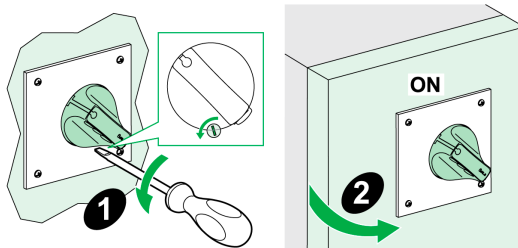

It is possible to temporarily disable this lock to open the door when the device is in the I (ON) position.

Disabling this lock requires modifying the rotary handle.

For more information, refer to [GHD16295AA](#), TeSys GV5 / GV6 - Rotary Handle MCC Adapter Plate - Instruction Sheet.

If the lock has been disabled, the following direct rotary handle functions are inoperative:

- Door locking
- Preventing the device from being closed when the door is open

Testing a Device With Extended Rotary Handle

Push-to-Trip Procedure

⚠ CAUTION

HAZARD OF NUISANCE TRIPPING

Device tests must only be done by qualified electrical personnel.

Failure to follow these instructions can result in injury or equipment damage.

When testing the trip mechanism take precautions against:

- Disrupting operations
- Activating inappropriate alarms
- Triggering unwanted actions

For example, tripping the device with the push-to-trip button can lead to inappropriate detected fault indications or corrective actions (such as switching to an alternate power source).

There is no push-to-trip button on the door of a device with an extended rotary handle. To check the trip mechanism, the door must first be opened.

Follow these steps to test the trip mechanism:

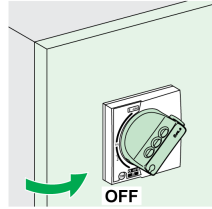
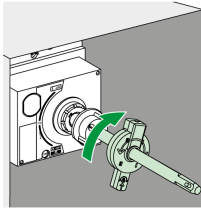
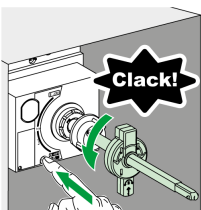
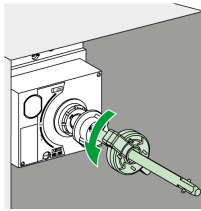
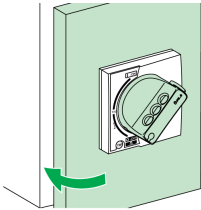
Step	Action	Position	
1		Switch the device to the open O (OFF) position. Open the door.	O (OFF)
2		Turn the device from the O (OFF) position to the I (ON) position, using one of the following tools: <ul style="list-style-type: none"> • An open door shaft operator (LV426937). • A flat wrench, taking care not to damage the extension shaft or its surface treatment. The extension shaft is a hollow rectangular tube, 15 x 10 mm (0.59 x 0.39 in). The device is ready for the test.	I (ON)
3		Press the push-to-trip button. The device trips.	Trip
4		Use a special tool (refer to step 2) to turn the extension shaft counterclockwise and switch the device from the Trip position to the O (OFF) position. The device is in the open position.	O (OFF)
5		Close the door.	–

Locking a Device With Extended Rotary Handle

Handle Locking

The extended rotary handle offers several locking functions to:

- Prevent the rotary handle being operated.
- Prevent the door being opened.

Some locking functions can be disabled on different adaptations.

The handle can be locked with up to three padlocks (not supplied).

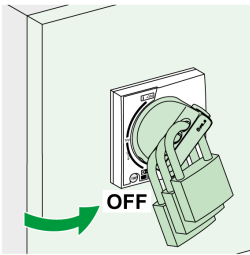
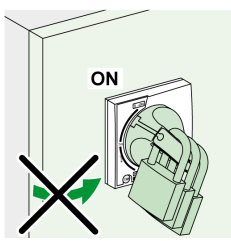
Handle locking		Padlocks
	<p>Padlocking (standard) in the O (OFF) position. Padlocking the rotary handle in the O (OFF) position does not prevent the door from opening.</p>	<p>Lock rotary handle with up to three padlocks (not supplied) with shackle diameters of 5–8 mm (0.2–0.3 in).</p>
	<p>Padlocking (after modification to the rotary handle during installation) in the two positions I (ON) and O (OFF). See instruction sheet GHD16292AA for rotary handle modification. There are two options when locking the rotary handle in the I (ON) position:</p> <ul style="list-style-type: none"> • Standard with the door opening locked. • As an option, door is not interlocked, and locking the rotary handle does not stop the door from opening. 	<p>Lock rotary handle with up to three padlocks (not supplied) with shackle diameters of 5–8 mm (0.2–0.3 in).</p>

NOTE: Locking the rotary handle in the **I (ON)** position does not disable the device protection functions. If there is a detected electrical fault, the device still trips. When unlocked, the rotary handle moves to the **Trip** position. To return the device to service, follow the resetting instructions ([see page 21](#)).

Door Locking (MCC Function)

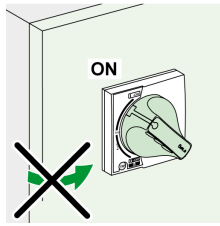

The extended rotary handle locks the door in the I (ON) position as standard.

⚠️ ⚠️ DANGER

HAZARD OF ELECTRIC SHOCK, EXPLOSION, OR ARC FLASH

Only qualified persons are authorized to disable the door lock.

Failure to follow these instructions will result in death or serious injury.

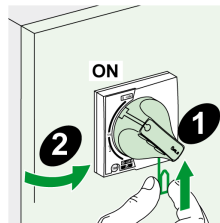

It is possible to temporarily disable this lock to open the door when the device is in the I (ON) position.

Disabling this lock requires modifying the rotary handle.

For more information, refer to:

- [GHD16292AA](#), TeSys GV5 - Extended Rotary Handle - Instruction Sheet.
- [GHD16320AA](#), TeSys GV6 - Extended Rotary Handle - Instruction Sheet.

Example: An application includes a device for a switchboard incoming supply and several device protecting motors with extended rotary handles installed behind the same door. Locking the door with the rotary handle of the incoming supply device simplifies maintenance work on the switchboard.

Sealing Accessories

Use sealing accessories to help prevent circuit breaker operations.

De-Energizing the Device

Isolation Capacity

TeSys GV5PB / GV6PB devices offer positive contact indication and are suitable for isolation in accordance with UL 489 Supplement SH standards. The O (OFF) position of the actuator is sufficient to isolate the device concerned.

The following marking on the rating plate label indicates that the device is capable of isolation:



TeSys GV5PB / GV6PB devices using locking accessories or with rotary handles can be locked in the O (OFF) position to allow work to be carried out with the power off in accordance with installation rules. Devices with standard handles can be locked with locking accessories. The device can only be locked in the open position if the device is in the O (OFF) position.

NOTE: Locking a TeSys GV5PB / GV6PB device in the open position is sufficient to isolate the device.

Maintenance and Servicing Work on Installation

DANGER

HAZARD OF ELECTRIC SHOCK, EXPLOSION, OR ARC FLASH

- Apply appropriate personal protective equipment (PPE) and follow safe electrical work practices. See NFPA 70E or CSA Z462 or local equivalent.
- This equipment must only be installed and serviced by qualified electrical personnel.
- Turn off all power supplying this equipment before working on or inside equipment.
- Always use a properly rated voltage sensing device to confirm that power is off.
- Replace all devices, doors, and covers before turning on power to this equipment.
- Immediately repair sources of short circuit or overload conditions before resetting the motor protection circuit breaker.

Failure to follow these instructions will result in death or serious injury.

Turn off all power supplying the equipment before working on or inside equipment. For a partial powering down of the installation, the installation and safety rules require clearly labeling and isolating the feed being worked on.

Maintenance Work Following a Trip on a Detected Electrical Fault

WARNING

HAZARD OF CLOSING ON A DETECTED ELECTRICAL FAULT

Do not close the device again without first inspecting and, if necessary, repairing the downstream electrical equipment.

Failure to follow these instructions can result in death, serious injury, or equipment damage.

The following table describes the procedure to be followed after a trip on a detected electrical fault:

Step	Action
1	Isolate the feed before inspecting the downstream electrical equipment.
2	Look for the cause of the detected fault.
3	Inspect and, if necessary, repair the downstream equipment.
4	Inspect the equipment in the event of a short-circuit trip.
5	Close the device again.

NOTE: The fact that a protection has tripped does not remedy the cause of the fault detected on the downstream electrical equipment.

Checking the Settings

Checking settings does not require any particular precautions. The checks must be carried out by a qualified person.

Testing the Device

CAUTION

HAZARD OF NUISANCE TRIPPING

Protection tests must be done by qualified electrical personnel.

Failure to follow these instructions can result in injury or equipment damage.

When testing device trip mechanisms, precautions must be taken:

- To avoid disrupting operations.
- To avoid inappropriate actions or tripping of alarms.

For example, tripping the device with the push-to-trip button can lead to inappropriate detected fault indications or corrective actions (such as switching to a replacement power source).

Setting the Trip Unit

WARNING

HAZARD OF NUISANCE TRIPPING OR FAILURE TO TRIP

Protection setting adjustments must be done by qualified electrical personnel.

Failure to follow these instructions can result in death, serious injury, or equipment damage.

Modifying trip unit settings requires a thorough knowledge of the installation and safety rules.

Chapter 3

Protection Functions

What Is in This Chapter?

This chapter contains the following topics:

Topic	Page
Protection for Motor-Feeders	32
Motor Operating States	33
Trip Unit Description	34
Overload or Thermal Protection (ANSI 49)	36
Short-Time Protection (ANSI 51)	39
Instantaneous Protection (ANSI 50)	40
Phase Unbalance Protection (ANSI 46)	41

Protection for Motor-Feeders

Introduction

A motor-feeder must satisfy the general rules of NEC standards as per Article 430. This standard defines:

- Disconnection from power supply
- Short-circuit protection
- Overload protection
- Motor control or switching

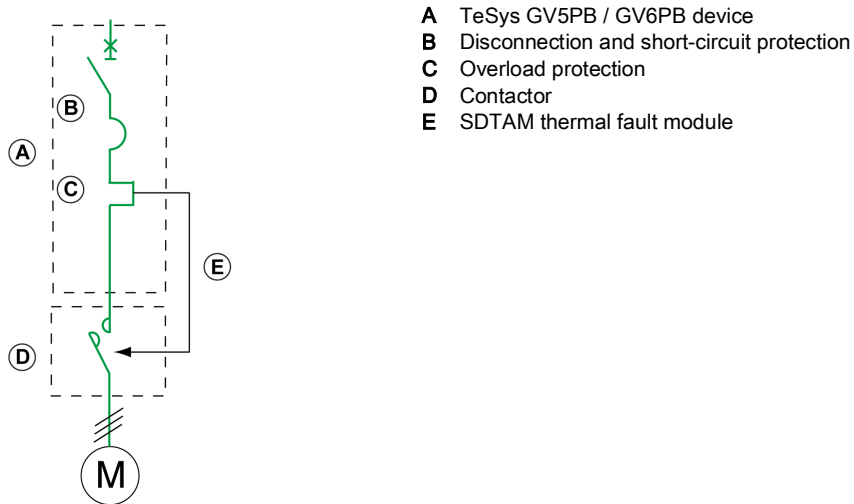

- A** TeSys GV5PB / GV6PB device
- B** Disconnection and short-circuit protection
- C** Overload protection
- D** Contactor
- E** SDTAM thermal fault module

Characteristics Defined by UL 489 Supplement SH

TeSys GV5PB / GV6PB devices:

- Provide protection for direct-on-line motor-feeders and star-delta motor starters (direct-on-line starting is the most widely used type of motor-feeder).
- Integrate the basic protections (overload, short-circuit, and phase unbalance) for the motor-feeder.
- Allow protection and coordination of the motor-feeder components that comply with the requirements of UL 489 Supplement SH.
- Are used to create motor-feeders with two devices.

Motor Operating States

Introduction

TeSys GV5PB / GV6PB devices consider the application to be operating as soon as the 10% of I_r pickup is crossed in a positive direction by the motor current.

Two operating states are considered:

- Startup state
- Steady state

Startup State

The application is considered to be in startup state according to the following criteria:

- Start: As soon as the 10% of I_r pickup is crossed in a positive direction by the motor current.
- End: As soon as the I_d pickup equals $1.5 \times I_r$ and the t_d time delay equals 10 s (non-adjustable parameters).

Exceeding the 10 s time delay does not result in tripping.

NOTE: The trip unit filters the subtransient state (first current peak of approximately 20 ms on contactor closing). This current peak is not therefore taken into account when assessing whether the I_d pickup has been crossed.

Steady State

The application is considered to be in steady state according to the following criteria:

- Start: As soon as startup ends.
- End: As soon as the 10% of I_r pickup is crossed in a negative direction by the motor current.

Operating Diagram

The following diagrams show the two cases of transition between startup and steady state:

Operating states with current $I < I_d$ before end of t_d

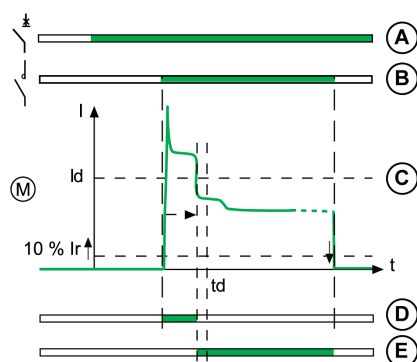

Operating states with current $I > I_d$ at end of t_d

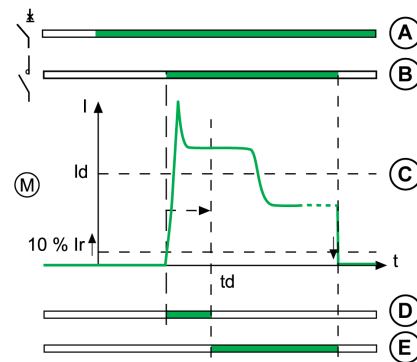

- A TeSys GV5PB / GV6PB devices status (green: ON position)
- B Contactor status (green: ON position)
- C Current in the motor
- D Operating state: startup state (green: active state)
- E Operating state: steady state (green: active state)

Trip Unit Description

Introduction

The trip unit is suitable for protecting motor-feeders in standard applications. The thermal trip curves are calculated for self-ventilated motors. The adjustment dials and indications are located on the front face.

Description

TeSys GV5PB trip unit

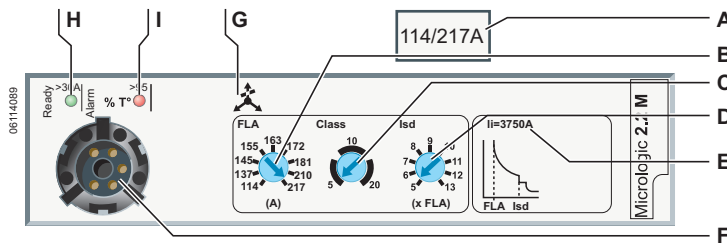

TeSys GV6PB trip unit

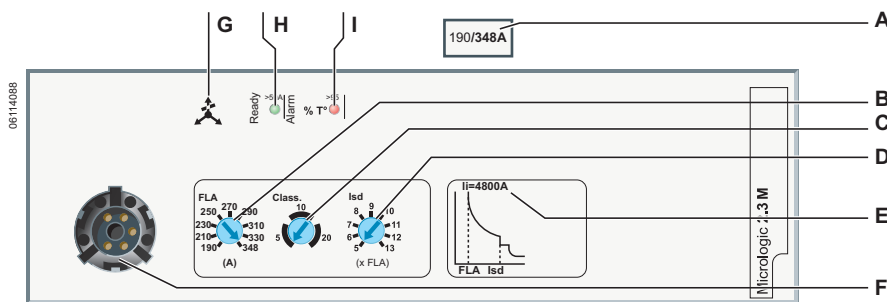

- A Micrologic 2.2 M/2.3 M electronic trip unit adjustment range
- B Adjustment dial for Full Load Amperes (FLA) I_r
- C Selection dial for the long-time protection time delay class
- D Adjustment dial for the short-time protection pickup I_{sd}
- E Value of instantaneous protection pickup I_i
- F Test port
- G Phase unbalance
- H Ready LED (green)
- I Alarm LED (green)

Indication LEDs



Indication LEDs on the front of the trip unit indicate its operational state.

Indication LED	Description
Green READY LED	Blinks slowly when the electronic trip unit is ready to provide protection.
Red ALARM LED	Overload temperature alarm LED: Shows a steady light when the thermal image of the motor exceeds 95% of the I_r setting.

The indication LEDs function for device load currents above 30 A.

Protection Functions

The following figure and table define the protection functions performed by the trip unit:

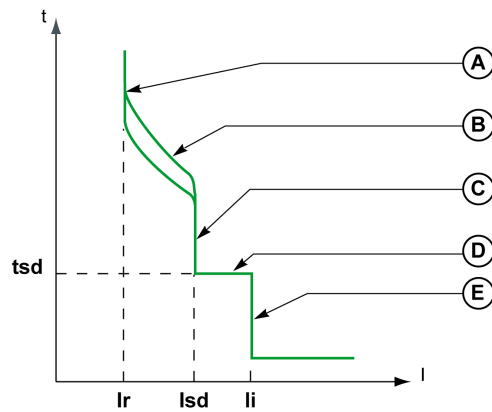

Item	Parameter	Description	Adjustable	Default setting	SDTAM activation
A	Ir	Overload or Full Load Amperes (FLA)	Yes	0.4 x In	Yes
B	Class	Trip class	Yes	10	Yes
C	Isd	Short-time protection pickup	Yes	13 x Ir	No
D	tsd	Short-time protection time delay	No	0.1 s	No
E	Ii	Instantaneous protection pickup	No	17 x In	No
-	Iunbal	Phase-unbalance protection pickup	No	30%	Yes
-	tunbal	Phase-unbalance protection time delay during startup	No	0.7 s	Yes
-		Phase-unbalance protection time delay in steady state	No	4 s	Yes

Each function is reviewed in detail on the following pages.

Setting the Protection

Set the overload or thermal protection pickup (Ir), the short-time protection pickup (Isd), and trip class (Class) by using the dials on the device.

Reflex Tripping

The GV6PB motor protection circuit breaker supports reflex tripping. The system of reflex protection breaks very high fault currents by mechanically tripping the device with a piston actuated directly by the pressure produced in the device from a short-circuit. This piston operates the opening mechanism, resulting in ultra-fast device tripping ([see page 58](#)).

Overload or Thermal Protection (ANSI 49)

Introduction

Overload or thermal protection protects all types of motor applications against overload currents.

GV5PB

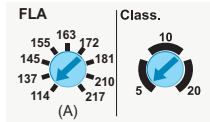

The long-time protection is set by two dials according to the starting characteristics of the application.

The pickup setting I_r for trip unit long-time protection is expressed in amperes:

- This value corresponds to the operating current used in the motor application.
- The maximum I_r setting corresponds to the trip unit rating I_n .

GV6PB

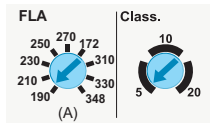

Operating Principle

Overload or thermal protection is I^2t IDMT (Inverse Definite Minimum Time):

- It incorporates the motor thermal image function.
- It can be configured as the I_r pickup and as the trip class (Class).

Tripping curve:

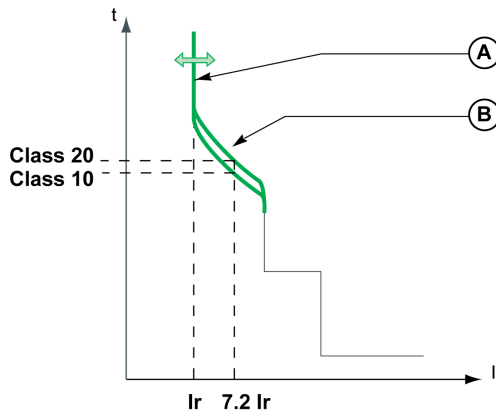

Item	Parameter	Description
A	I_r	Overload or Full Load Amperes (FLA)
B	Class	Overload or thermal protection trip class

I_r Pickup Setting Value

The overload or thermal protection pickup (I_r) is set by using a multi-position dial.

The default I_r pickup setting value is $0.4 \times I_n$ (minimum dial value).

The overload or thermal protection tripping range is $1.05-1.20 \times I_r$ according to IEC/EN 60947-4-1 standard.

The following table shows the preset values of the adjustment dial I_r in amperes for each current rating I_n :

Trip unit rating I_n (A)	150 A	250 A	400 A	600 A
Pickup I_r (A)	58	114	190	312
	71	137	210	338
	79	145	230	364
	86	155	250	390
	91	163	270	416
	97	172	290	442
	110	181	310	468
	119	210	330	494
	130	217	348	524

Trip Class Setting Value

The trip class (Class) is set by using an adjustment dial:

- Class 5
- Class 10 (default value)
- Class 20

The trip class corresponds to the value of the tripping time for a current of $7.2 \times I_r$ according to IEC/EN 60947-4-1 standard.

The following table shows the value of the tripping time depending on the current in the load for all three classes:

Current in the load	Tripping time (in seconds)		
	Class 5	Class 10	Class 20
$1.5 \times I_r$	96-120	192-240	320-400
$6 \times I_r$	5.2-6.5	10.8-13.5	20.8-26
$7.2 \times I_r$	4-5	8-10	16-20

The precision range is -20%, + 0%

Motor Thermal Image

The model representing heat rise and cooling in a motor load is constructed according to the algorithm for calculating the thermal demand, taking account of the iron and copper losses.

The following figure represents the limit curves for the iron and copper components calculated for class 20:

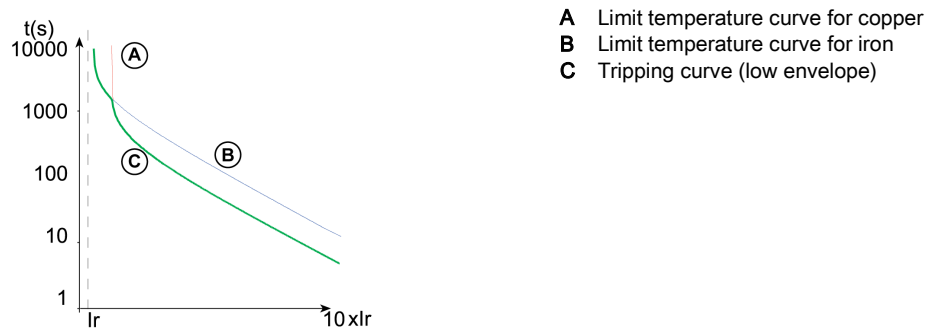

- A** Limit temperature curve for copper
- B** Limit temperature curve for iron
- C** Tripping curve (low envelope)

Thermal Memory

The trip unit uses a thermal memory function to protect the motor from overheating in case of repetitive low amplitude overload conditions.

Electronic protection without thermal memory function does not protect against repetitive low amplitude overload conditions because the duration of each overload above the pickup setting is too short to cause tripping. However, each overload causes a temperature rise in the installation. The cumulative effect of successive overloads can overheat the system. The thermal memory function remembers and integrates the thermal heating caused by each pickup setting overrun. The thermal memory function remembers the thermal heating values for 20 minutes before or after tripping.

Example: Comparison of the heat rise calculation without thermal image (diagram **A**) and with thermal image (diagram **B**):

Diagram **A**

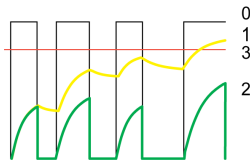
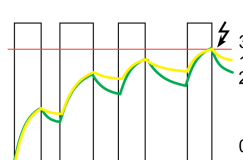

Diagram **B**



- 0 Load control (cyclical)
- 1 Motor temperature
- 2 Thermal level calculated without thermal image (diagram **A**), with thermal image (diagram **B**)
- 3 Overload or thermal protection level

With thermal image, the trip unit adds the thermal effect of successive current pulses. Tripping occurs based on the actual thermal state of the motor.

Cooling Fan

The thermal image of the motor is calculated taking account of the fact that the motor is self-cooled (fan mounted on the shaft end).

Short-Time Protection (ANSI 51)

Introduction

Short-time protection protects all types of motor applications against short-circuit currents.

Short-time protection lets through motor starting currents but protects cables and motor starter devices and allows not to oversize them (useful for wide range settings devices).

Operating Principle

Short-time protection is definite time. It can be configured as the I_{sd} pickup.

Tripping curve:

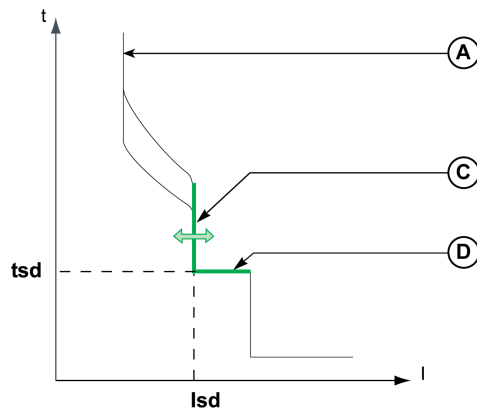

Item	Function	Description
A	I_r	Overload or thermal protection pickup
C	I_{sd}	Short-time protection pickup
D	t_{sd}	Short-time protection fixed time delay

I_{sd} Pickup Setting Value

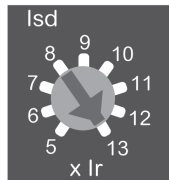

The short-time protection pickup I_{sd} is set by using a multi-position dial. The setting value is expressed in multiples of I_r .

Step	Action
1	Set the long-time protection first: the setting pickup is I_r (A).
2	Turn the I_{sd} adjustment dial to the value required. The setting range is 5 to 13 $\times I_r$ in steps of I_r .
3	I_{sd} is set to I_r (A) $\times I_{sd}$ setting.

The precision range is $\pm 15\%$.

t_{sd} Time Delay Value

The time delay cannot be adjusted.

- The hold time is 20 ms.
- The maximum breaking time is 60 ms.

Instantaneous Protection (ANSI 50)

Introduction

Instantaneous protection protects all types of motor applications against very high intensity short-circuit currents.

Operating Principle

Instantaneous protection is fixed: the pickup value is determined by the current rating I_n . Protection is instantaneous.

Tripping curve:

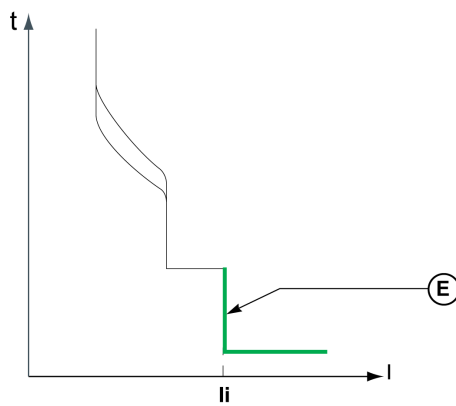

Item	Parameter	Description
E	Ii	Instantaneous protection pickup

Ii Pickup Value

The Ii pickup value is $15 \times I_n$ (trip unit rating I_n corresponds to the maximum Ir setting).

The precision range is $\pm 15\%$.

The maximum breaking time is 30 ms.

Phase Unbalance Protection (ANSI 46)

Introduction



Unbalances of the motor phase currents lead to significant heat rise and braking torques that can cause premature deterioration of the motor. These effects are amplified during startup: protection must be almost immediate.

Description

Phase unbalance protection:

- Calculates the current unbalance for each phase, compared to the average current, expressed as a percentage:

$$I_{avg} = \frac{(I_1 + I_2 + I_3)}{3}$$

$$I_k \text{ unbalance (\%)} = \frac{I_k - I_{avg}}{I_{avg}} \times 100 \text{ where } k = 1, 2, 3$$

- Compares the value of the maximum current unbalance with the lunbal protection pickup.

The following diagram shows a maximum positive unbalance on phase 2:

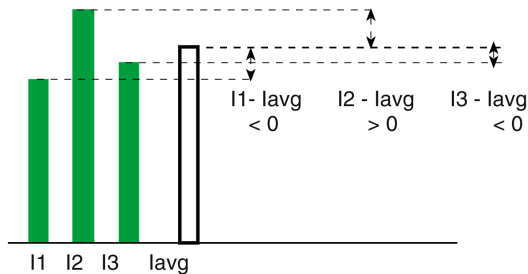

If the maximum current unbalance value is higher than the phase unbalance protection lunbal pickup, the tunbal time delay is actuated.

Phase unbalance protection cannot be deactivated.

Phase unbalance protection is activated during startup and in steady state.

Operating Principle

- The phase unbalance (or phase loss) protection trips if the current unbalance exceeds the 30% fixed pickup I_{unbal} during a fixed t_{unbal} time delay. The t_{unbal} time delay differs according to the motor operating conditions:
 - Start-up phase: $t_{unbal} = 0.7\text{ s}$
 - Steady state phase: $t_{unbal} = 4\text{ s}$

Phase loss is an extreme case of phase unbalance and leads to tripping under the same conditions.

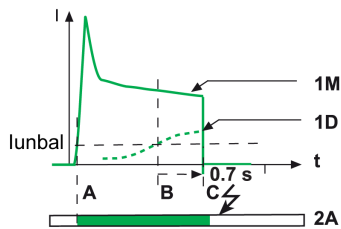

During startup:

- **A:** Activation of startup phase.
- **B:** Activation of protection time delay as soon as the pickup is crossed.
- **C:** Protection tripped at the end of the fixed time delay of 0.7 s.

- 1M** Motor current
- 1D** Maximum unbalance of the motor phase currents
- 2A** Monitoring by phase unbalance protection during startup
White: Not active
Green: Active

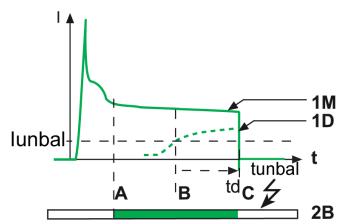

In steady state:

- **A:** Activation of steady state phase.
- **B:** Activation of protection time delay as soon as the pickup is crossed.
- **C:** Protection tripped at the end of the fixed time delay of 4 s.

- 1M** Motor current
- 1D** Maximum unbalance of the motor phase currents
- 2B** Monitoring by phase unbalance protection in steady state
White: Not active
Green: Active

- The phase unbalance protection does not trip if the current unbalance falls below the I_{unbal} pickup before the end of the fixed t_{unbal} time delay.

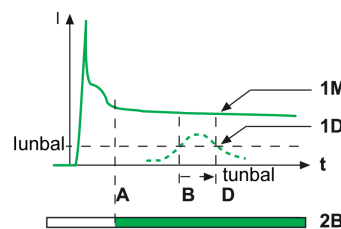

- **A:** Activation of steady state phase.
- **B:** Activation of protection time delay as soon as the pickup is crossed.
- **D:** Time delay is reset.

- 1M** Motor current
- 1D** Maximum unbalance of the motor phase currents
- 2B** Monitoring by phase unbalance protection in steady state
White: Not active
Green: Active

Chapter 4

Electrical Auxiliary Devices

What Is in This Chapter?

This chapter contains the following topics:

Topic	Page
Electrical Auxiliary Devices	44
Indication Contacts	47
Voltage Trip Releases	49
SDTAM Thermal Fault Module	50

Electrical Auxiliary Devices

Summary of Electrical Auxiliary Devices

The following table shows electrical auxiliary devices that can be added to devices. They can be installed on site. For more information, see the *TeSys Motor Control and Protection Components Catalog*.

Electrical auxiliary device	Use
OF auxiliary contact	View the on/off status of the device remotely.
SD auxiliary contact	View the trip status of the device remotely.
SDE auxiliary contact	Indicate that the device has tripped on a detected electrical fault.
AU undervoltage trip release	Trip the device when the control voltage drops below a tripping threshold.
AS shunt trip	Send an electrical trip command remotely to trip the device.
SDTAM thermal fault module	Provide alarm and detected fault differentiation.

Slots for Electrical Auxiliary Devices on TeSys GV5PB Devices

The following table shows the possible slots for electrical auxiliary devices mounted in the case.

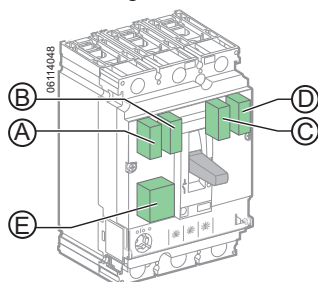

Electrical auxiliary device	Slot				
	A	B	C	D	E
OF1 auxiliary contact	✓	–	–	–	–
OF2 auxiliary contact	–	–	–	✓	–
SD auxiliary contact	–	✓	–	–	–
SDE auxiliary contact (with addition of the optional SDE adapter)	–	–	✓	–	–
AU undervoltage trip release	–	–	–	–	✓
AS shunt trip	–	–	–	–	✓
SDTAM thermal fault module	✓	–	–	–	✓

NOTE: It is not possible to install all the accessories at the same time in one device. For example, SDTAM thermal fault module uses the same slot as AU undervoltage trip release or AS shunt trip.

Slots for Electrical Auxiliary Devices on TeSys GV6PB Devices

The following table shows the possible slots for electrical auxiliary devices mounted in the case.

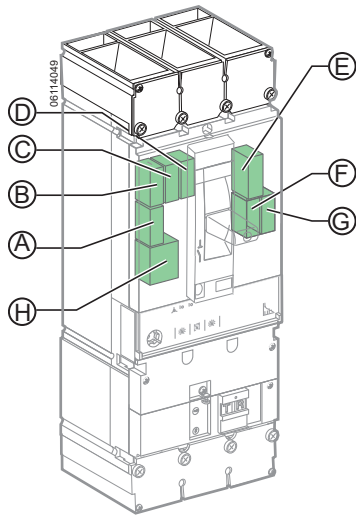

Electrical auxiliary device	Slot							
	A	B	C	D	E	F	G	H
OF1 auxiliary contact	-	✓	-	-	-	-	-	-
OF2 auxiliary contact	-	-	✓	-	-	-	-	-
OF3 auxiliary contact	-	-	-	✓	-	-	-	-
OF4 auxiliary contact	-	-	-	-	-	-	✓	-
SD auxiliary contact	-	-	-	-	✓	-	-	-
SDE auxiliary contact (with embedded SDE adapter)	-	-	-	-	-	✓	-	-
AU undervoltage trip release	-	-	-	-	-	-	-	✓
AS shunt trip	-	-	-	-	-	-	-	✓
SDTAM thermal fault module	✓	-	-	-	-	-	-	✓

NOTE: It is not possible to install all the accessories at the same time in one device. For example, SDTAM thermal fault module uses the same slot as AU undervoltage trip release or AS shunt trip.

Operation of the Auxiliary Indication Contacts

The following table shows the position of the indication contacts (or outputs) relative to the position of the actuator and main contacts.

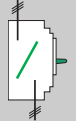
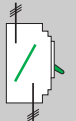
	Position of the actuator and the main contacts							
	 ON	 Tripped by:						 OFF
		AU/AS	PT ⁽¹⁾	Trip unit ⁽²⁾				
				Ir	Isd	Ii	Iunbal	
Name	Position of indication contacts							
OF	✓	-	-	-	-	-	-	-
SD	-	✓	✓	✓	✓	✓	✓	-
SDE	-	-	-	✓	✓	✓	✓	-
SDTAM - Output 1 (SDT thermal fault indication)	-	-	-	✓✓	-	-	✓✓	-
SDTAM - Output 2 (contactor control)	-	-	-	✓✓	-	-	✓✓	-
✓: Contact closed, ✓✓: Early-make output (400 ms)								
(1) PT: Push-to-trip (2) Ir: Overload or thermal protection Isd: Short-time protection Ii: Instantaneous protection Iunbal: Phase-unbalance protection								

Indication Contacts

Introduction

Use indication contacts to view the status of the device remotely.

The indication contact provides either OF, SD, or SDE indication functions, depending on its location in the device.

Indication contacts are located under the front face of the device, in a compartment isolated from the power circuits.

Description

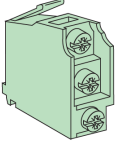
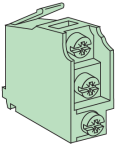
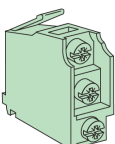
Name	Image	Definition
OF open/close indication contact		The OF contact indicates the position of the main contacts of the device (open or closed).
SD trip indication contact		The SD contact indicates that the device has tripped due to: <ul style="list-style-type: none"> ● Operation of the push-to-trip button ● Operation of the AU undervoltage trip release or AS shunt trip ● Overload or thermal protection ● Short-time protection ● Instantaneous protection ● Phase-unbalance protection
SDE contact		The SDE contact indicates that the device has tripped on a detected electrical fault due to: <ul style="list-style-type: none"> ● Overload or thermal protection ● Short-time protection ● Instantaneous protection ● Phase-unbalance protection

Characteristics

The contacts used for indication contacts are the common point changeover type.

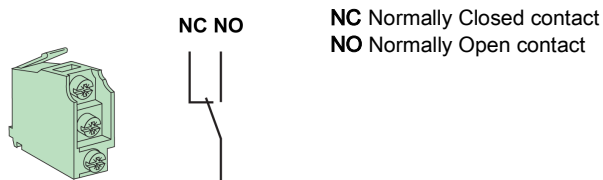

Operation of the Indication Contacts

The following figures show the position of the indication contacts for each position of the handle and main contacts.

Name	Contact number	Position of the handle and contacts			
Handle position	–				
Device status	–	OFF	ON	Tripped on a detected electrical fault	Tripped (by AU/AS or push-to-trip protection)
Main contact position	–	Open	Closed	Open	Open
OF auxiliary contact position	•1→2	Closed	Open	Closed	Closed
	•1→4	Open	Closed	Open	Open
SD auxiliary contact position	•1→2	Closed	Closed	Open	Open
	•1→4	Open	Open	Closed	Closed
SDE auxiliary contact position	•1→2	Open	Open	Closed	Open
	•1→4	Closed	Closed	Open	Closed

Wiring Diagram

The diagram is shown with circuits de-energized, all devices open, connected, and charged, and relays in normal position.

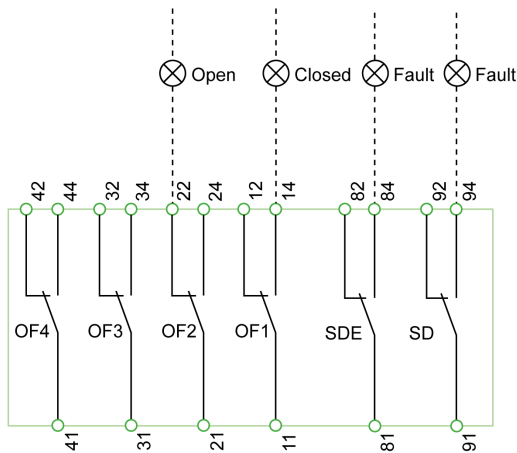

Indication contacts	Description
OF4/OF3/OF2/OF1	Device ON/OFF indication contacts
SDE	Detected electrical fault trip indication contact (short-circuit, overload, phase-unbalance)
SD	Trip indication contact

Voltage Trip Releases

Introduction

The following voltage trip release auxiliaries are operated remotely by an electrical trip command:

- AU undervoltage trip release
- AS shunt trip

NOTE: It is recommended to test the operation of a voltage trip release at regular intervals, such as every six months.

Voltage trip release auxiliaries are installed in the case under the front face of the device.

Description

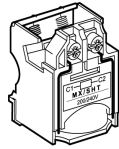
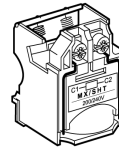
Name	Image	Description
AU undervoltage trip release		<p>AU undervoltage trip release:</p> <ul style="list-style-type: none"> • Trips the device when the voltage is less than 0.35 times the rated voltage of the release. <ul style="list-style-type: none"> ○ If the voltage is between 0.35 and 0.7 times the rated voltage of the release, tripping can occur but is not certain to occur. ○ If the voltage is above 0.7 times the rated voltage of the release, tripping cannot occur. • Allows the device to be closed again when the voltage reaches 0.85 times the rated voltage of the release. <p>Use this type of trip release for emergency stops.</p>
AS shunt trip		<p>AS shunt trip:</p> <ul style="list-style-type: none"> • Trips the device when the voltage exceeds 0.7 times the rated voltage of the release. • Operates by impulse type control signals maintained for ≥ 20 ms.

Characteristics

The characteristics of voltage trip release auxiliaries comply with IEC/EN 60947-2 recommendations.

Wiring diagram

The diagrams is shown with circuits de-energized, all devices open, connected, and charged, and relays in normal position.

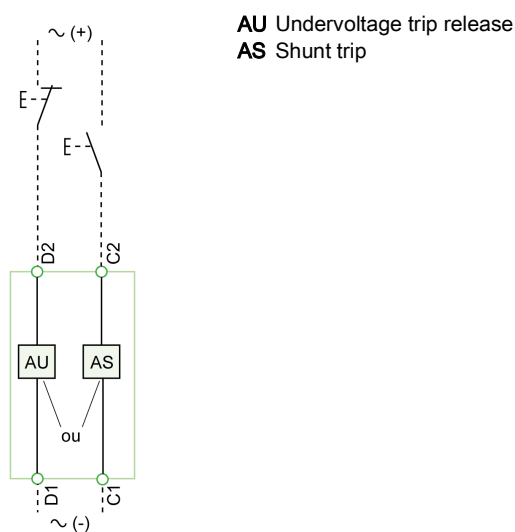

SDTAM Thermal Fault Module

Introduction

Use the SDTAM thermal fault module to manage tripping due to overload.

The SDTAM thermal fault module receives data from the trip unit through an optical link and makes available two outputs assigned to:

- Overload indication
- Motor contactor control

Description

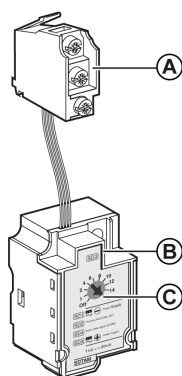

- A Output terminals
- B SDTAM thermal fault module
- C Operating mode adjustment dial

Characteristics

The characteristics of the SDTAM thermal fault module outputs are:

- Voltage: 24–415 Vac/Vdc
- Current:
 - Active outputs: 80 mA maximum
 - Idle outputs: 0.25 mA

Installation

The slots used to install the SDTAM thermal fault module depend on the device.

TeSys GV5PB

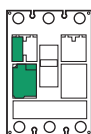

TeSys GV6PB

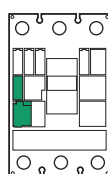

The SDTAM thermal fault module uses the same slot as:

- AU undervoltage trip release, AS shunt trip, or OF1 auxiliary contact in a TeSys GV5PB device.
- AU undervoltage trip release or AS shunt trip in a TeSys GV6PB device.

Wiring diagram

Connect the SDTAM thermal fault module and the two outputs in strict accordance with the wiring diagram. The diagram is shown with circuits de-energized, all devices open, connected and charged and relays in normal position.

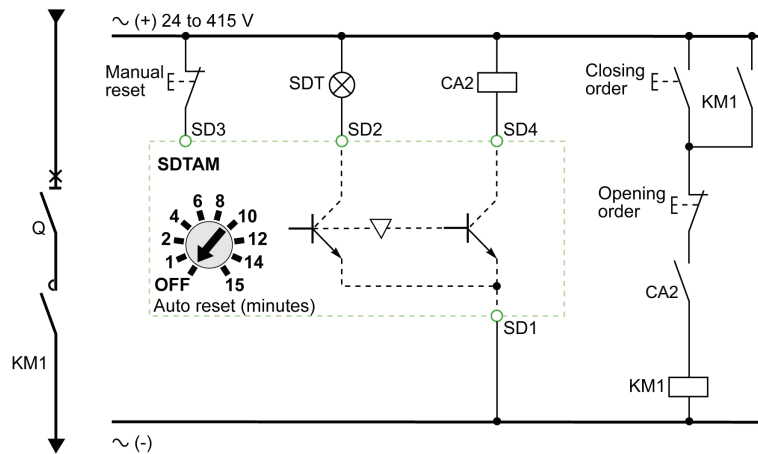

Item	Description
SD1, SD3	Thermal fault module input power supply
SD2	Detected overload fault signal output. This output maintains its state until reset.
SD4	Contactor control output
KM1	LC1D or LC1F contactor
CA2	CA2, CAD, or Zelio-type control relay

Output Assignment

Output 1 (SD2/OUT1): normally open, indicates thermal faults.

Output 2 (SD4/OUT2): normally closed, opens the contactor KM.

Outputs are activated 400 ms before the device trips in the case of:

- Overload or thermal protection
- Phase-unbalance protection

Contactor Control

Contactor control by the output 2 signal (SD4/OUT2) optimizes continuity of service and provides the following additional benefits:

- Lower risk of motor deterioration.
- Activation of the output indicates that the application is not working normally. Abnormal operation is not the result of an anomaly or internal condition in the motor-feeder.
- The cause of this abnormal operation can be temporary (for example, a voltage drop causing an overly long starting time).

When the cause of the overload or unbalance has disappeared, the equipment can be powered up again.

NOTE: To control a contactor with a consumption exceeding 80 mA, it is necessary to provide a control relay.

Operating Modes



The SDTAM thermal fault module incorporates an auto-reset delay setting dial.

To return the outputs to their initial state following activation:

- Manual (SDTAM dial in the OFF position) after canceling the module power supply.
- Automatic (SDTAM dial on one of the time delay adjustment settings) following a time delay (set from 1 to 15 minutes to allow for the motor cooling time).

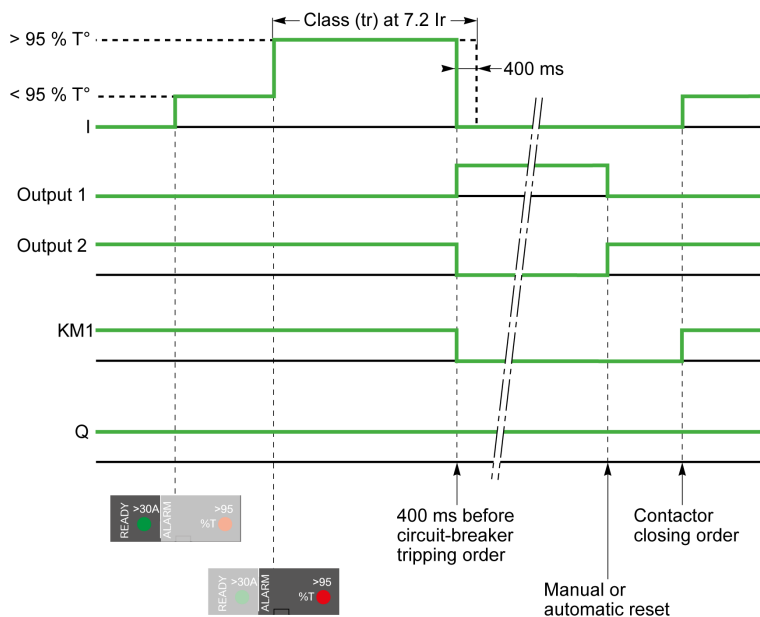

Item	Description
I	Motor current
Output 1	SDTAM detected overload fault signal output
Output 2	SDTAM contactor control output
KM1	Motor contactor
Q	TeSys GV5PB / GV6PB device

Appendices



Appendix A

Additional Characteristics

What Is in This Chapter?

This chapter contains the following topics:

Topic	Page
Motor-Feeder Protection	56
Reflex Tripping	58
Limitation Curves	59

Motor-Feeder Protection

TeSys GV5PB150• and TeSys GV5PB250• Tripping Curves

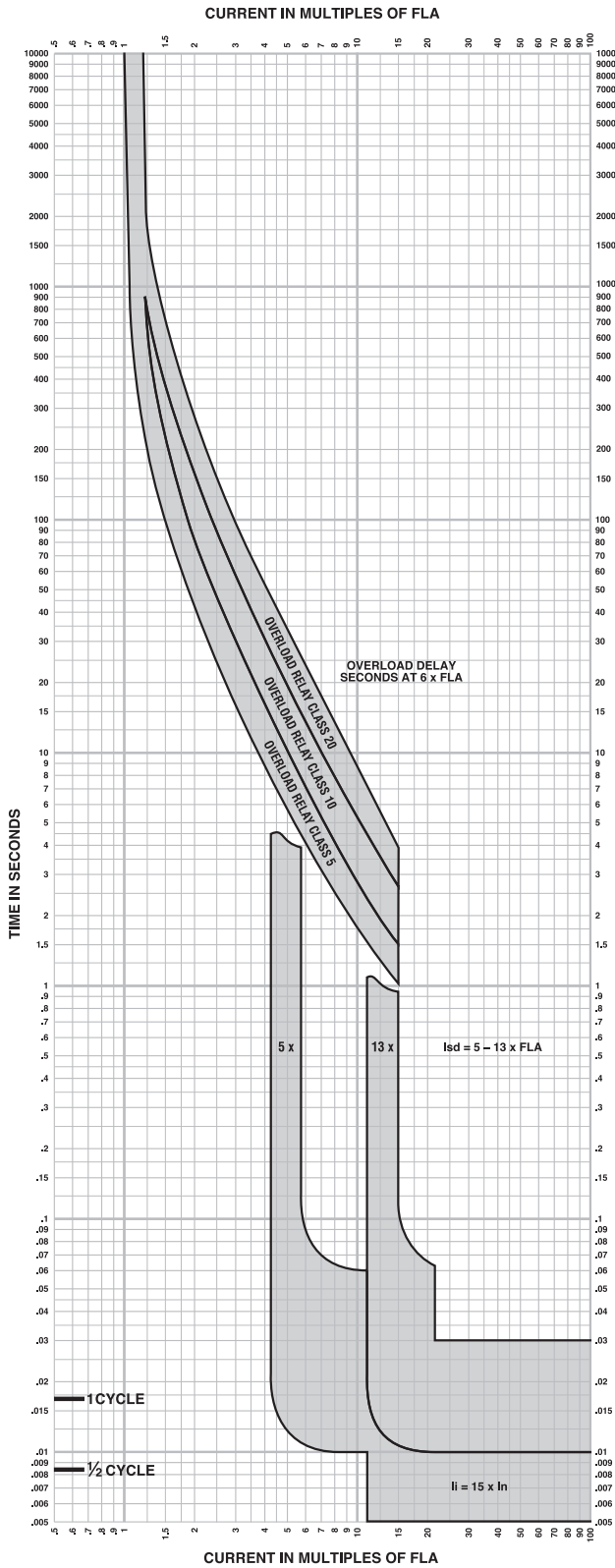

The time-current curve information is to be used for application and coordination purposes only.

Notes:

1. If overload still exists past overload relay delay, motor protection circuit breaker will open 0.4 seconds later.
2. Total clearing times shown include the response times of the trip unit, the circuit breaker opening, and the extinction of the current.
3. Isd minimum and maximum only shown.
4. $I_i = 15 \times I_n$
 $I_n = 150A, 250A$
 Motor protection circuit breaker will trip <30ms at $15 \times I_n$

Curves apply from -35°C to +70°C (-31°F to +158°F) ambient temperature.

TeSys GV6PB400• and GV6PB600• Tripping Curves

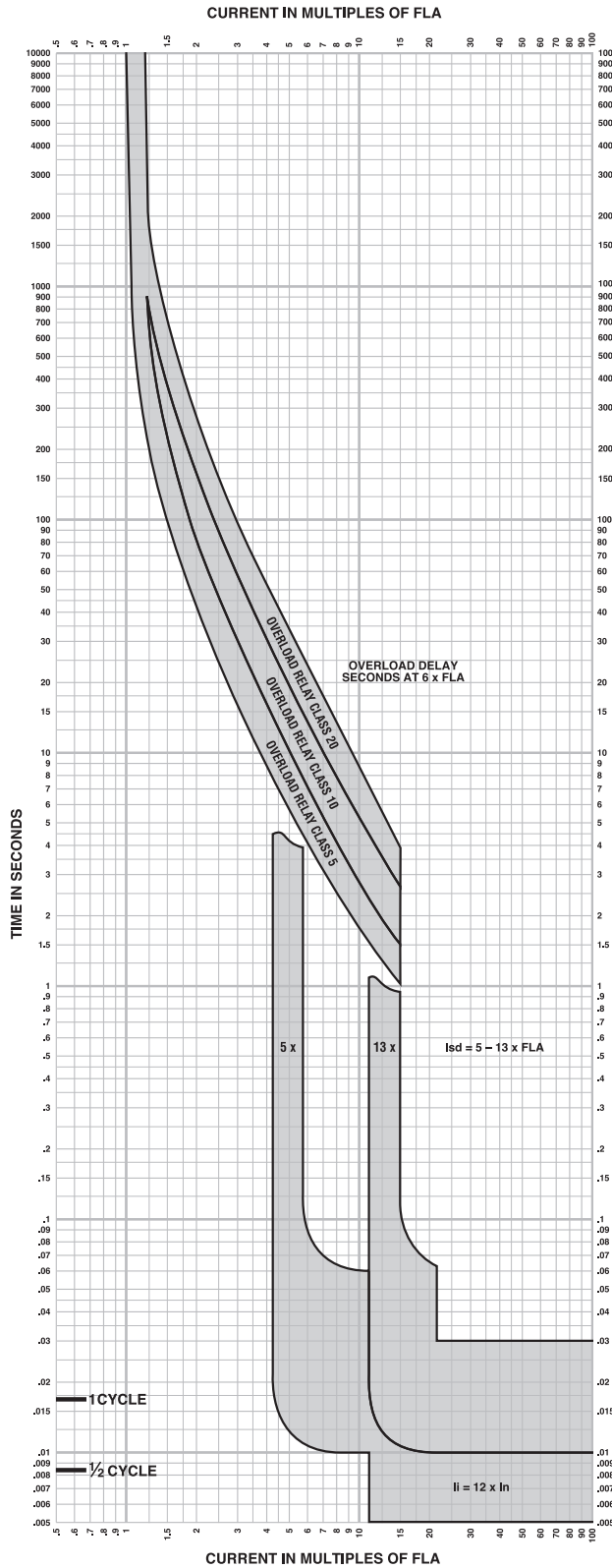

The time-current curve information is to be used for application and coordination purposes only.

Notes:

1. If overload still exists past overload relay delay, motor protection circuit breaker will open 0.4 seconds later.
2. Total clearing times shown include the response times of the trip unit, the circuit breaker opening, and the extinction of the current.
3. Isd minimum and maximum only shown.
4. $I_i = 12 \times I_n$
 $I_n = 400A, 600A$
 Motor protection circuit breaker will trip <30ms at $12 \times I_n$

Curves apply from -35°C to +70°C (-31°F to +158°F) ambient temperature.

Reflex Tripping

Introduction

TeSys GV6PB devices incorporate the exclusive reflex-tripping system.

This system breaks very high fault currents.

The device is mechanically tripped via a “piston” actuated directly by the short-circuit.

For high short-circuits, this system provides a faster break, thereby ensuring discrimination.

Reflex-tripping curves are exclusively a function of the device rating.

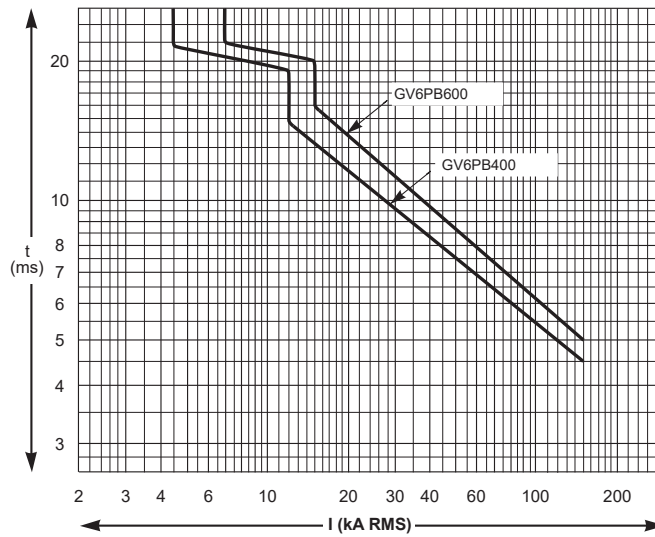

Limitation Curves

Introduction

The limiting capacity of a device is its aptitude to let through a current, during a short-circuit, that is less than the prospective short-circuit current.

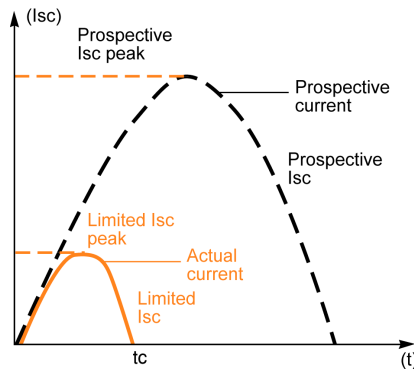

The exceptional limiting capacity of TeSys GV5PB / GV6PB devices is due to the rotating double-break technique (very rapid natural repulsion of contacts and the appearance of two arc voltages in-series with a very steep wave front). GV5/GV6 devices reduce current limit, but are not listed as current limiting devices.

Reduced Let-Through Currents

The moving contact has the shape of an elongated “S” and rotates around a floating axis. The shape of the fixed and moving contacts is such that the repelling forces appear as soon as the circuit reaches approximately 15 times I_n .

Due to the rotating movement, repulsion is rapid and the device greatly limits short-circuit currents, whatever the interrupting level of the unit. The short-circuit current is extinguished before it can fully develop. Lower let-through currents provide less peak energy, reducing the required bus bar bracing, lowering enclosure pressure, and delivering improved series or combination ratings.

Longer Service Life of Electrical Installations

Current-limiting devices greatly reduce the negative effects of short-circuits on installations.

- Thermal effects: Reduced temperature rise in conductors, therefore longer service life for cables.
- Mechanical effects: Reduces electrodynamic forces, therefore less risk of electrical contacts, or busbar being deformed or broken.
- Electromagnetic effects: Reduction in disturbances for measuring devices located near electric circuits.

Economy by Means of Cascading

Cascading is a technique directly derived from current limiting.

Devices with breaking capacities less than the prospective short-circuit current may be installed downstream of a limiting device.

The breaking capacity is reinforced by the limiting capacity of the upstream device.

It follows that substantial savings can be made on downstream equipment and enclosures.

Current and Energy Limiting Curves

The limiting capacity of a device is expressed by two curves which are a function of the prospective short-circuit current (the current which would flow if no protection devices were installed):

- The actual peak current (limited current)
- Thermal stress (A^2s), that is, the energy dissipated by the short-circuit in a condition with a resistance of 1Ω .

Current-limiting Curves

The following figures show TeSys GV5PB / GV6PB current-limiting curves.

GV5PB150 Peak Let-through Current (Ip)

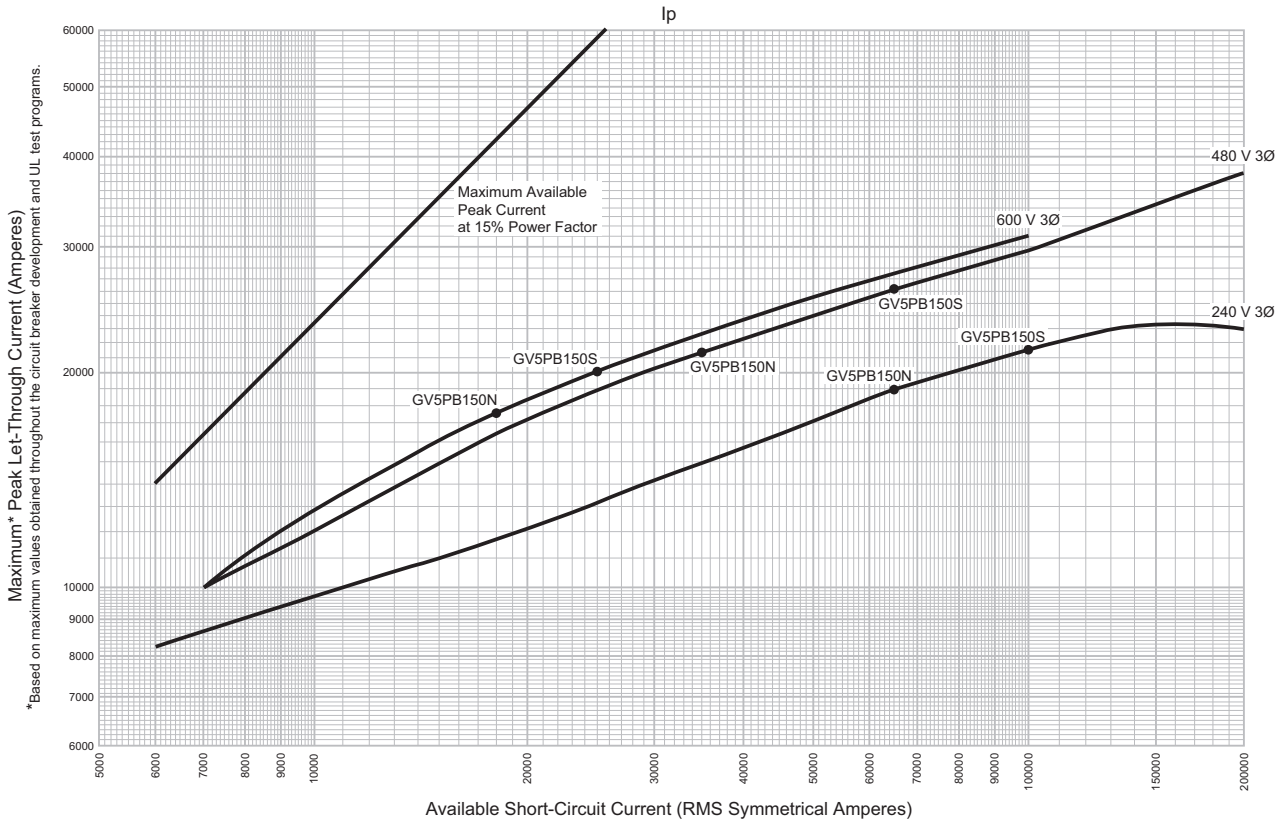

GV5PB250 Peak Let-through Current (Ip)

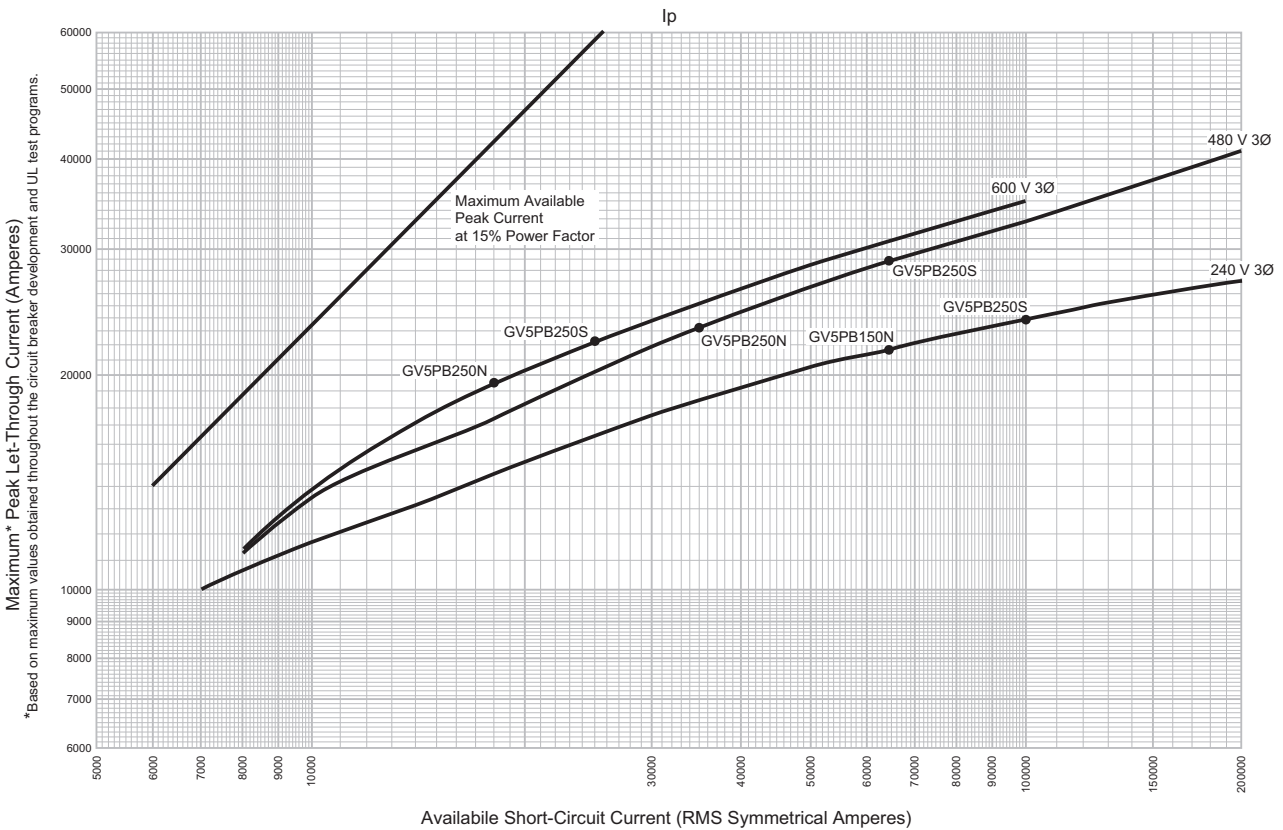

GV6PB Peak Let-through Current (I_p)

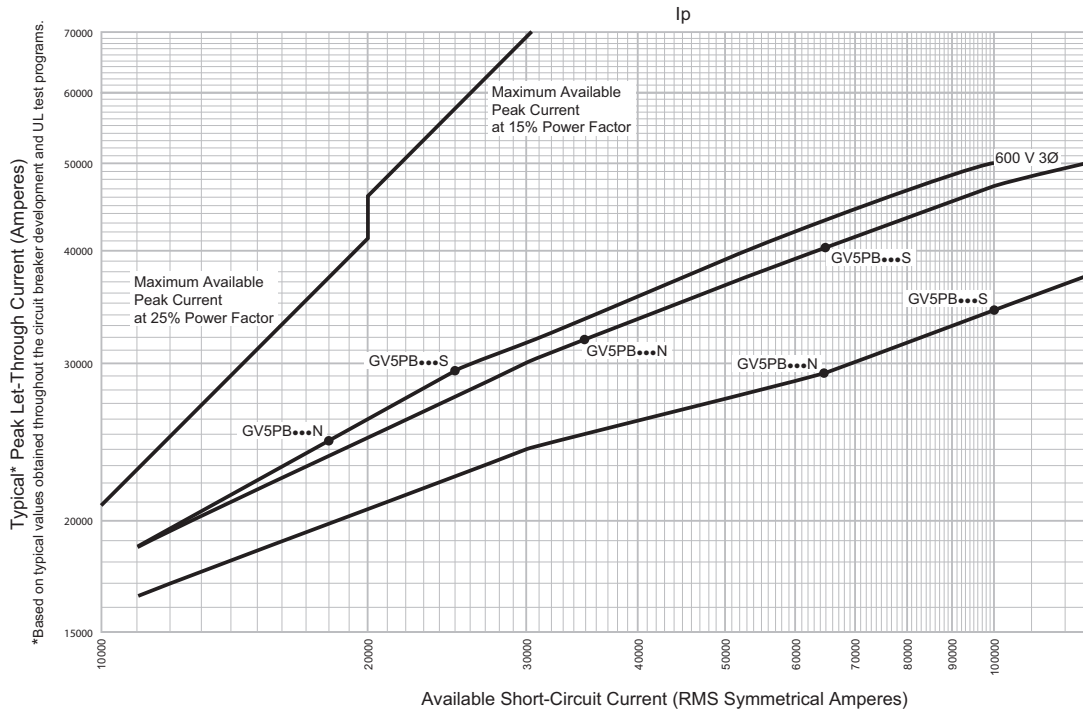

Energy-limiting Curves

The following figures show TeSys GV5PB / GV6PB energy-limiting curves.

GV5PB150 Let-through Current (I^2t)

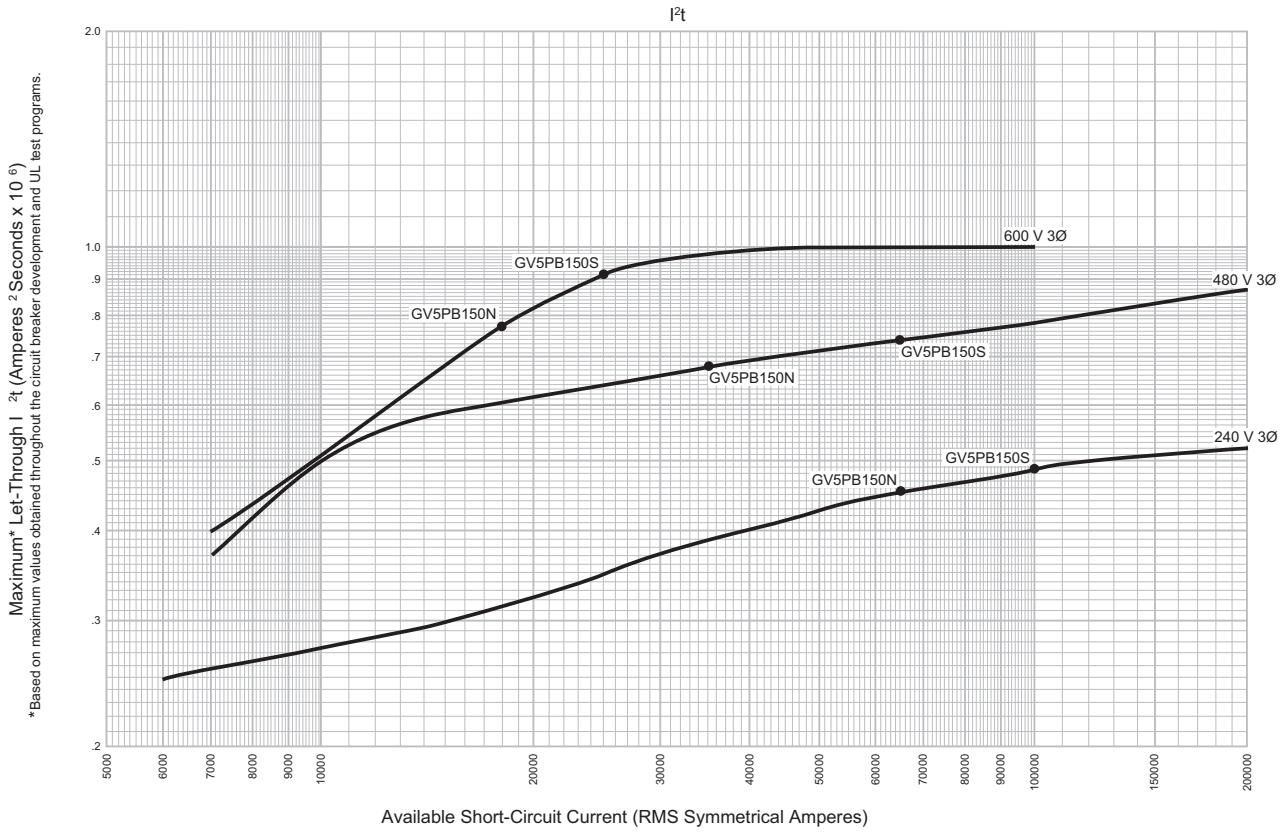

GV5PB250 Let-through Current (I^2t)

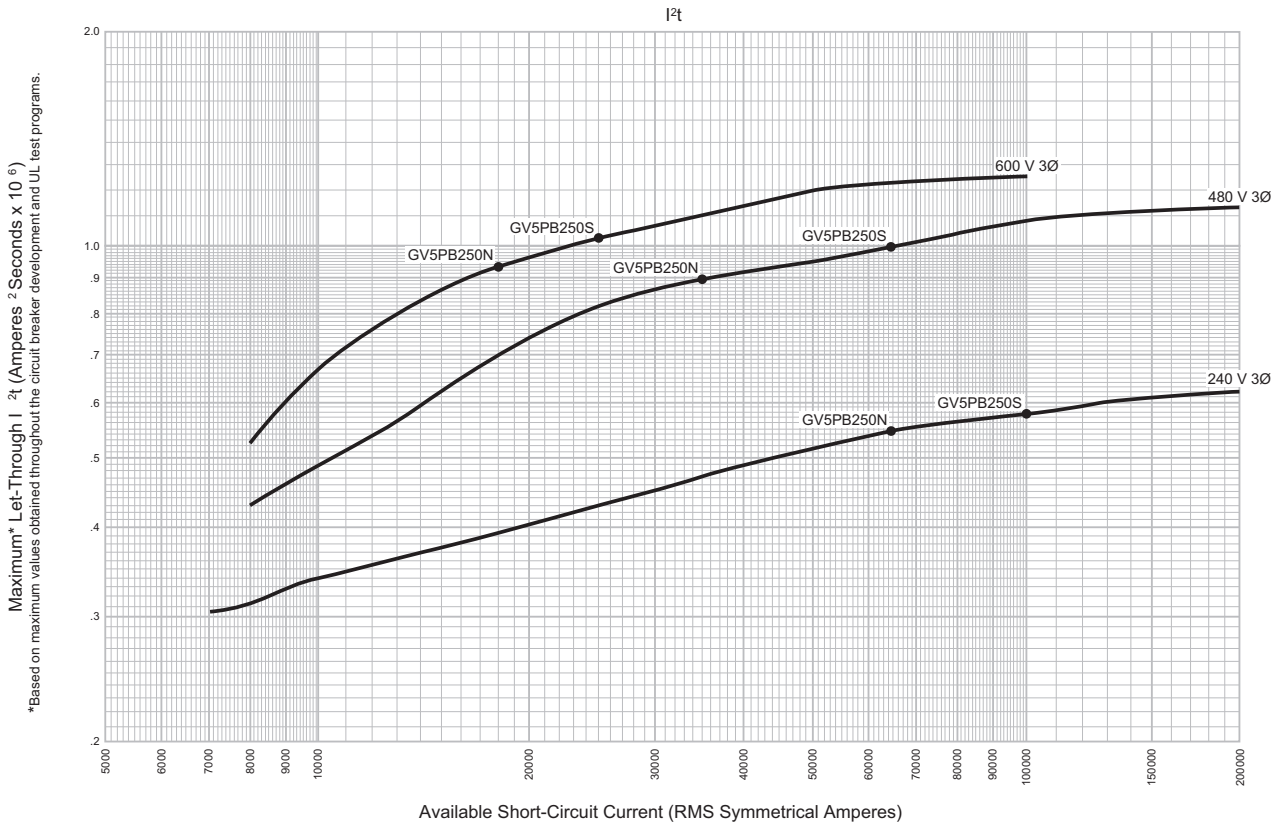

GV6PB Let-through Current (I^2t)

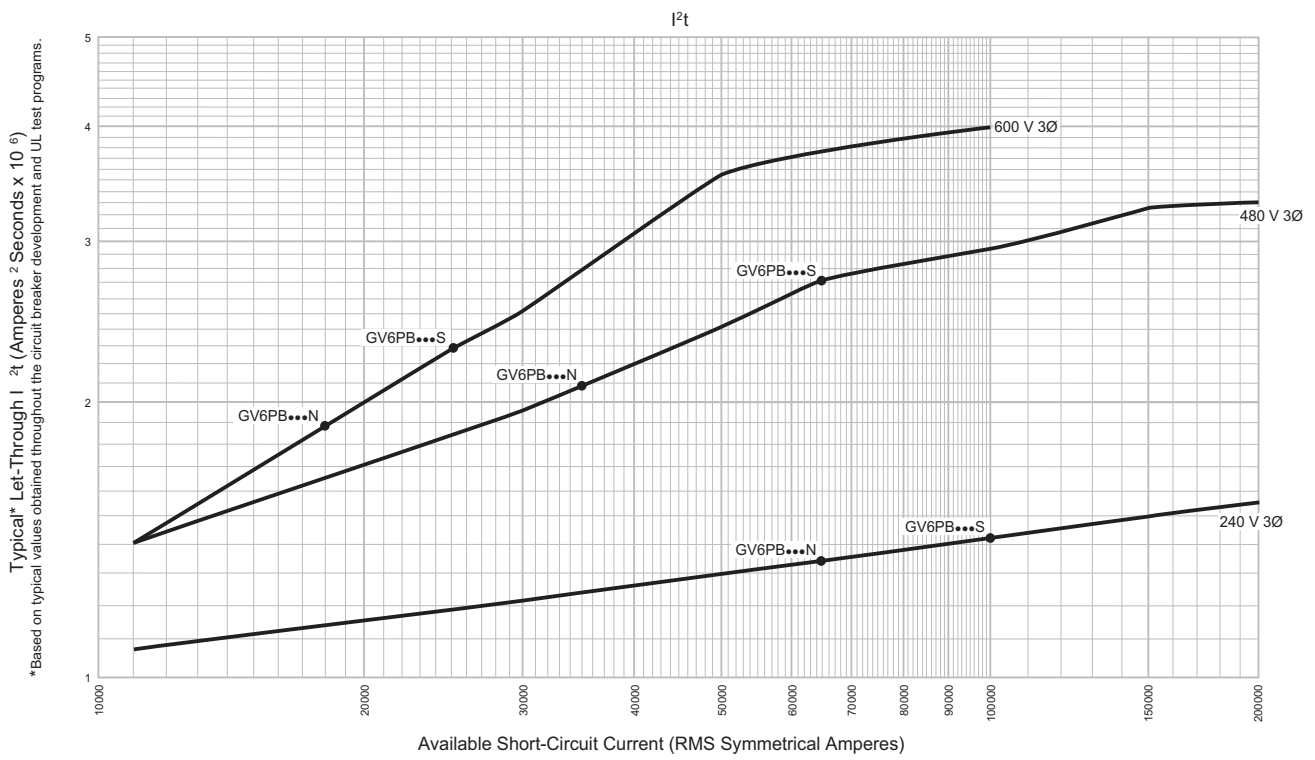



A

AS: Shunt trip

This type of release operates when supplied with current. The shunt (SHT) release provokes circuit breaker opening when it receives a pulse-type or maintained command.

AU: Undervoltage release

This type of release (UVR) operates when the supply voltage drops below the set minimum.

Auxiliary contact (IEC 60947-1)

Contact included in an auxiliary circuit and mechanically operated by the switching device.

B

Breaking capacity

Value of prospective current that a switching device is capable of breaking at a stated voltage under prescribed conditions of use and behavior. Reference is generally made to the ultimate breaking capacity (I_{cu}) and the service breaking capacity (I_{cs}).

C

Circuit breaker (IEC 60947-2)



Mechanical switching device, capable of making, carrying, and breaking currents under normal circuit conditions and making, carrying for a specified time and breaking currents under specified abnormal circuit conditions such as those of short-circuits. Circuit breakers are the device of choice for protection against overloads and short-circuits. Circuit breakers can, as is the case for TeSys GV, be suitable for isolation.

Connection terminal

Flat copper surface, linked to the conducting parts of the device, and to which power connections are made using bars, connectors or lugs.

Contact (IEC 60947-1)



Mechanical switching device having only one position of rest, operated otherwise than by hand, capable of making, carrying and breaking currents under normal circuit conditions including operating overload conditions. A contactor is provided for frequent opening and closing of circuits under load or slight overload conditions. It must be combined and coordinated with a protective device against overloads and short-circuits, such as a circuit breaker.

Contact utilization categories (IEC 60947-4-1)

The standard defines four utilization categories, AC1, AC2, AC3 and AC4 depending on the load and the control functions provided by the contactor. The class depends on the current, voltage and power factor, as well as contactor withstand capacity in terms of frequency of operation and endurance.

D

Degree of protection - IP•• (IEC 60529)

Defines device protection against the penetration of solid objects and liquids, using two digits specified in IEC 60529 standard. Each digit corresponds to a level of protection, where 0 indicates no protection.

- First digit (0 to 6): Protection against penetration of solid foreign objects. 1 corresponds to protection against objects with a diameter less than 50 mm, 6 corresponds to total protection against dust.
- Second digit (0 to 8): Protection against penetration of liquids (water). 1 corresponds to protection against falling drops of water (condensation), 8 corresponds to continuous immersion.

The enclosure of TeSys GV motor protection circuit breakers provides a minimum of IP40 (protection against objects less than 1 mm).

Direct rotary handle

This is a control handle for the circuit breaker. It has the same three positions I (ON), O (OFF) and TRIP as the toggle control. It provides IP40 and IK07 protections. It maintains suitability for isolation and offers optional locking using a padlock.

Durability

The term “durability” is used in the standards instead of “endurance” to express the expectancy of the number of operating cycles which can be performed by the equipment before repair or replacement of parts. The term “endurance” is used for specifically defined operational performance.

E**Electrical durability**

With respect to its resistance to electrical wear, equipment is characterized by the number of on-load operating cycles, corresponding to the service conditions given in the relevant product standard, which can be made without replacement.

Electronic trip unit

Trip unit that continuously measures the current flowing through each phase and the neutral if it exists. For Micrologic, the measurements are provided by built-in current sensors linked to an analog-digital converter with a high sampling frequency. The measurement values are continuously compared by the ASIC to the protection settings. If a setting is overrun, a Mitop release trips the circuit breaker operating mechanism. This type of trip unit offers much better pick-up and delay setting accuracy than thermal-magnetic trip units. It also provides a wider range of protection functions.

Extended rotary handle

Rotary handle with an extended shaft to control devices installed at the rear of switchboards. It has the same characteristics as direct rotary handles. It offers multiple locking possibilities using a padlock or a door interlock.

I**Ics: Service breaking capacity**

Expressed as a percentage of Icu, it provides an indication on the robustness of the device under severe conditions. It is confirmed by a test with one opening and one closing/opening at Ics, followed by a check that the device operates correctly at its rated current.

Icu: Ultimate breaking capacity

Expressed in kA, it indicates the maximum breaking capacity of the circuit breaker. It is confirmed by a test with one opening and one closing/opening at Icu, followed by a check that the circuit is properly isolated.

Ie: Rated operational current

A rated operational current of an equipment is stated by the manufacturer and takes into account the rated operational voltage, the rated frequency, the rated duty, the utilization category and the type of protective enclosure, if appropriate.

Ii: Instantaneous protection

This protection supplements I_{sd}. It provokes instantaneous opening of the device. The pick-up may be adjustable or fixed (built-in). This value is always lower than the contact-repulsion level.

In: Rated current

The rated current corresponds to the current that the device can carry continuously with the contacts closed and without abnormal temperature rise.

Ir: Oervload or thermal protection

Protection function where the adjustable I_r pick-up determines a protection curve similar to the thermal-protection curve (inverse-time curve I²t). The curve is generally determined on the basis of the I_r setting which corresponds to a theoretically infinite tripping time (asymptote) and of the point at 6 I_r at which the tripping time depends on the rating.

I_{sd}: Short-time protection with fixed time delay

This protection supplements thermal protection. Short-time protection, but with a fixed time delay. This function is available on Micrologic 2M. The short-time pick-up I_{sd} is adjustable from approximately 5 to 13 I_r.

Unbal: Phase-unbalance or phase-loss protection

This protection function steps in if the current values and/or the unbalance in the three phases supplying the motor exceeds tolerances. Currents should be equal and displacement should be one third of a period. Phase-loss is a special case of phase-unbalance.

M**Maximum breaking time**

Maximum time after which breaking is effective, which is when the contacts are separated and the current is completely interrupted.

MCC rotary handle

Handle used for motor control centers and providing IP43 and IK07 protections.

Mechanical durability

With respect to its resistance to mechanical wear, equipment is characterized by the number of no-load operating cycles which can be effected before it becomes necessary to service or replace any mechanical parts.

Minimum clearances

When installing a circuit breaker, minimum distances must be maintained between the device and panels, bars and other protection systems installed nearby. These distances, which depend on the ultimate breaking capacity, are defined by tests carried out in accordance with IEC 60947-2 standard.

P**Power loss / Pole resistance**

The flow of current through the circuit breaker poles produces Joule-effect losses caused by the resistance of the poles.

R**Release (IEC 60947-1)**

A device which is mechanically connected to a mechanical switching device (for example a circuit breaker), which releases the holding means and permits the opening or the closing of the switching device. For circuit breakers, releases are often integrated in a trip unit.

Remote tripping

Remote tripping is carried out by an opening mechanism using an AU undervoltage release (UVR) in conjunction with an emergency off button. If power is lost, the protection device opens the circuit breaker.

S**SDTAM thermal fault module**

Relay module with two static outputs specifically for the motor-protection Micrologic 2 M trip units. An output, linked to the contactor coil, opens the contactor when an overload or other motor fault is detected, thus avoiding opening of the circuit breaker. The other output stores the opening event in memory.

Spreader

Set of three flat conducting parts made of aluminum. They are screwed to the circuit breaker terminals to increase the pitch between poles.

Starting current

Start-up of a three-phase, asynchronous motor is characterized by:

- A high inrush current, approximately $14 \times I_n$ for 10 to 15 ms
- A starting current, approximately $7.2 \times I_n$ for 5 to 30 seconds
- Return to the rated current after the starting time

Starting time

Time after which the motor ceases to draw the starting current and falls back to the operating current I_r ($\leq I_n$).

Static output

Output of a relay made up of a thyristor or triac electronic component. The low switching capability means that a power relay is required. This is the case for the SDTAM outputs.

T**Thermal image of the rotor and stator**

The thermal image models the thermal behavior of a motor rotor and stator, taking into account temperature rise caused by overloads or successive starts, and the cooling constants. For each motor power rating, the algorithm takes into account a theoretical amount of iron and copper which modifies the cooling constants.

Thermal protection

Protection against over currents following an inverse time curve $I^2t = \text{constant}$, which defines the maximum permissible temperature rise for the motor. Tripping occurs after a time delay that decreases with increasing current.

Trip class (IEC 60947-4-1)

The trip class determines the trip curve of the thermal protection device for a motor feeder. The standard defines trip classes 5, 10, 20, and 30. These classes are the maximum durations, in seconds, for motor starting with a starting current of $7.2 \times I_r$, where I_r is the thermal setting indicated on the motor rating plate.

U**Ue: Rated operational voltage**

A value of voltage which, combined with a rated operational current, determines the application of the equipment and to which the relevant tests and the utilisation categories are referred. For multiple equipment, it is generally stated as the voltage between phases. This is the maximum continuous voltage at which the equipment may be used.

Ui: Rated insulation voltage

The rated insulation voltage of an equipment is the value of voltage to which dielectric tests and creepage distances are referred. In no case shall the maximum value of the rated operational voltage exceed that of the rated insulation voltage.

Uimp: Rated impulse withstand voltage

The peak value of an impulse voltage of prescribed form and polarity which the equipment is capable of withstanding without failure under specified conditions of test and to which the values of the clearances are referred. The rated impulse withstand voltage of an equipment shall be equal to or higher than the values stated for the transient over voltages occurring in the circuit in which the equipment is fitted.

DOCA0161ENUS-00

Schneider Electric USA, Inc.
800 Federal Street
Andover, MA 01810
USA

www.se.com

As standards, specifications and designs change from time to time, please ask for confirmation of the information given in this publication.

© 2019 Schneider Electric. All Rights Reserved. Schneider Electric and TeSys are trademarks and the property of Schneider Electric, its subsidiaries, and affiliated companies. All other trademarks are the property of their respective owners.