



# WTB12V-24162120A00

## W12

SMALL PHOTOELECTRIC SENSORS

**SICK**  
Sensor Intelligence.



Illustration may differ



### Ordering information

Type	Part no.
WTF12V-24162120A00	1125931

Other models and accessories → [www.sick.com/W12](http://www.sick.com/W12)

### Detailed technical data

#### Features

<b>Functional principle</b>	Photoelectric proximity sensor
<b>Functional principle detail</b>	Foreground suppression
<b>Sensing range</b>	
Sensing range min.	0 mm
Sensing range max.	140 mm
Adjustable switching threshold for background suppression	50 mm ... 140 mm
Reference object	Object with 90% remission factor (complies with standard white according to DIN 5033)
Minimum object height at set sensing range in front of black background (6% remission factor)	4 mm, at a distance of 90 mm
Recommended sensing range for the best performance	50 mm ... 100 mm
<b>Emitted beam</b>	
Light source	Laser
Type of light	Visible red light
Shape of light spot	Line-shaped
Light spot size (distance)	1.2 mm x 32 mm (100 mm)
Maximum dispersion of the emitted beam around the standardized transmission axis (squint angle)	< +/- 1.0° (at Ta = +23 °C)
<b>Key laser figures</b>	
Normative reference	EN 60825-1:2014, IEC 60825-1:2014

Laser class	1
Wave length	655 nm
Pulse duration	4 $\mu$ s
Maximum pulse power	< 6.74 mW
Average service life	50,000 h at $T_U = +25$ °C
<b>Adjustment</b>	
Teach-Turn adjustment	BluePilot: For setting the sensing range
IO-Link	For configuring the sensor parameters and Smart Task functions
<b>Indication</b>	
LED blue	BluePilot: sensing range indicator
LED green	Operating indicator Static on: power on Flashing: IO-Link mode
LED yellow	Status of received light beam Static on: object present Static off: object not present
<b>Special features</b>	Line-shaped light spot
<b>Special applications</b>	Detecting small objects, Detection of objects moving at high speeds, Detecting flat objects, Detecting perforated objects

### Safety-related parameters

<b>MTTF<sub>D</sub></b>	280 years
<b>DC<sub>avg</sub></b>	0 %
<b>T<sub>M</sub> (mission time)</b>	10 years (EN ISO 13849, rate of use: 60 %)

### Communication interface

<b>IO-Link</b>	✓, IO-Link V1.1
Data transmission rate	COM2 (38,4 kBaud)
Cycle time	2.3 ms
Process data length	16 Bit
Process data structure	Bit 0 = switching signal $Q_{L1}$ Bit 1 = switching signal $Q_{L2}$ Bit 2 ... 15 = Current receiver level (live)
VendorID	26
DeviceID HEX	0x8002D1
DeviceID DEC	8389329
Compatible master port type	A
SIO mode support	Yes

### Electrical data

<b>Supply voltage <math>U_B</math></b>	10 V DC ... 30 V DC <sup>1)</sup>
<b>Ripple</b>	$\leq 5$ V
<b>Usage category</b>	DC-12 (According to EN 60947-5-2) DC-13 (According to EN 60947-5-2)

<sup>1)</sup> Limit values.

<sup>2)</sup> Signal transit time with resistive load in switching mode.

<sup>3)</sup> With light/dark ratio 1:1.

<sup>4)</sup> This switching output must not be connected to another output.

<b>Current consumption</b>	≤ 14 mA, without load. At $U_B = 24\text{ V}$	
<b>Protection class</b>	III	
<b>Digital output</b>		
	Number	2 (Complementary)
	Type	Push-pull: PNP/NPN
	Signal voltage PNP HIGH/LOW	Approx. $U_B - 2.5\text{ V} / 0\text{ V}$
	Signal voltage NPN HIGH/LOW	Approx. $U_B / < 2.5\text{ V}$
	Output current $I_{\max}$ .	≤ 100 mA
	Circuit protection outputs	Reverse polarity protected Overcurrent protected Short-circuit protected
	Response time	≤ 500 $\mu\text{s}$ <sup>2)</sup>
	Repeatability (response time)	150 $\mu\text{s}$ <sup>2)</sup>
	Switching frequency	1,000 Hz <sup>3)</sup>
<b>Pin/Wire assignment</b>		
	BN 1	+ (L+)
	WH 2	$\bar{Q}_{L1}/\text{MF}$ Digital output, dark switching, object present → output $\bar{Q}_{L1}$ HIGH <sup>4)</sup> The pin 2 function of the sensor can be configuredAdditional possible settings via IO-Link
	BU 3	- (M)
	BK 4	$Q_{L1}/\text{C}$ Digital output, light switching, object present → output $Q_{L1}$ LOW <sup>4)</sup> The pin 4 function of the sensor can be configuredAdditional possible settings via IO-Link

<sup>1)</sup> Limit values.

<sup>2)</sup> Signal transit time with resistive load in switching mode.

<sup>3)</sup> With light/dark ratio 1:1.

<sup>4)</sup> This switching output must not be connected to another output.

## Mechanical data

<b>Housing</b>	Rectangular	
<b>Dimensions (W x H x D)</b>	15.6 mm x 49.5 mm x 43.1 mm	
<b>Connection</b>	Male connector M12, 4-pin	
<b>Connection detail</b>		
	Deep-freeze property	Do not bend below 0 °C
<b>Material</b>		
	Housing	Metal, zinc diecast
	Front screen	Plastic, PMMA
	Male connector	Plastic, VISTAL®
<b>Weight</b>	Approx. 77 g	
<b>Maximum tightening torque of the fixing screws</b>	1.4 Nm	

## Ambient data

<b>Enclosure rating</b>	IP66 (EN 60529) IP67 (EN 60529) IP69 (EN 60529)
<b>Ambient operating temperature</b>	-20 °C ... +55 °C

<b>Ambient temperature, storage</b>	-40 °C ... +70 °C
<b>Warm-up time</b>	< 15 min, Where $T_u$ is under -10 °C
<b>Typ. Ambient light immunity</b>	Artificial light: $\leq 50,000$ lx Sunlight: $\leq 50,000$ lx
<b>Shock resistance</b>	50 g, 11 ms (25 positive and 25 negative shocks along X, Y, Z axes, 150 total shocks (EN60068-2-27))
<b>Vibration resistance</b>	10 Hz ... 2,000 Hz (Amplitude 0.5 mm / 10 g, 20 sweeps per axis, for X, Y, Z axes, 1 octave/min, (EN60068-2-6))
<b>Air humidity</b>	35 % ... 95 %, Relative humidity (no condensation)
<b>Electromagnetic compatibility (EMC)</b>	EN 60947-5-2
<b>Resistance to cleaning agent</b>	ECOLAB
<b>UL File No.</b>	NRKH.E181493 & NRKH7.E181493

### Smart Task

<b>Smart Task name</b>	Base logics
<b>Logic function</b>	Direct AND OR
<b>Timer function</b>	Deactivated On delay Off delay ON and OFF delay Impulse (one shot)
<b>Inverter</b>	Yes
<b>Switching frequency</b>	SIO Logic: 900 Hz <sup>1)</sup> IOL: 800 Hz <sup>2)</sup>
<b>Response time</b>	IOL: 600 $\mu$ s <sup>2)</sup>
<b>Repeatability</b>	SIO Logic: 200 $\mu$ s <sup>1)</sup> IOL: 250 $\mu$ s <sup>2)</sup>
<b>Switching signal</b>	Switching signal $Q_{L1}$ Switching output Switching signal $\bar{Q}_{L1}$ Switching output

<sup>1)</sup> Use of Smart Task functions without IO-Link communication (SIO mode).

<sup>2)</sup> Use of Smart Task functions with IO-Link communication function.

### Diagnosis

<b>Device temperature</b>	Measuring range	Very cold, cold, moderate, warm, hot
<b>Device status</b>		Yes
<b>Detailed device status</b>		Yes
<b>Operating hour counter</b>		Yes
<b>Operating hours counter with reset function</b>		Yes
<b>Quality of teach</b>		Yes

### Classifications

<b>ECLASS 5.0</b>	27270904
<b>ECLASS 5.1.4</b>	27270904
<b>ECLASS 6.0</b>	27270904

<b>ECLASS 6.2</b>	27270904
<b>ECLASS 7.0</b>	27270904
<b>ECLASS 8.0</b>	27270904
<b>ECLASS 8.1</b>	27270904
<b>ECLASS 9.0</b>	27270904
<b>ECLASS 10.0</b>	27270904
<b>ECLASS 11.0</b>	27270904
<b>ECLASS 12.0</b>	27270903
<b>ETIM 5.0</b>	EC002719
<b>ETIM 6.0</b>	EC002719
<b>ETIM 7.0</b>	EC002719
<b>ETIM 8.0</b>	EC002719
<b>UNSPSC 16.0901</b>	39121528

### Adjustments

Display and adjustment elements

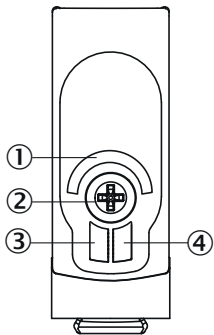

- ① LED blue
- ② Teach-Turn adjustment
- ③ LED green
- ④ LED yellow

### Connection type

M12 male connector, 4-pin

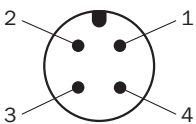

## Truth table

Push-pull: PNP/NPN - light switching Q

	Light switching Q (normally closed (upper switch), normally open (lower switch))	
	Object not present → Output HIGH	Object present → Output LOW
Light receive	✓	✗
Light receive indicator	☉	✗
Load resistance to L+	✗	⚠
Load resistance to M	⚠	✗

Push-pull: PNP/NPN – dark switching  $\bar{Q}$

	Dark switching $\bar{Q}$ (normally open (upper switch), normally closed (lower switch))	
	Object not present → Output LOW	Object present → Output HIGH
Light receive	✓	✗
Light receive indicator	☉	✗
Load resistance to L+	⚠	✗
Load resistance to M	✗	⚠

## Characteristic curve

Minimum object height in mm (inch)

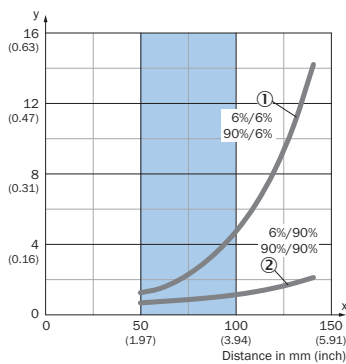

Example:  
Reliable detection of the object

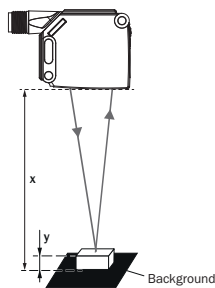

Black background (6 % remission factor)  
Distance of sensor to background x = 90 mm  
Required minimum object height y = 4 mm  
For all objects regardless of their colors

- ① Black background, 6% remission factor
- ② White background, 90% remission factor

### Light spot size

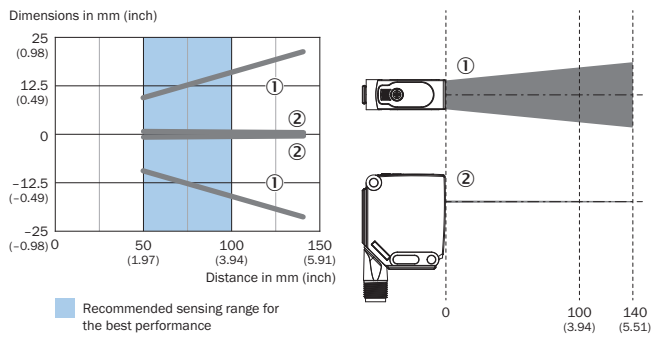

- ① Light spot horizontal
- ② Light spot vertical

### Sensing range diagram

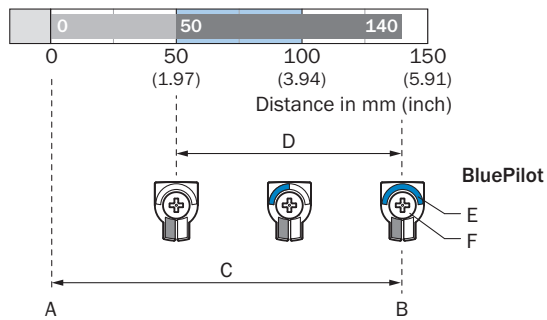

Recommended sensing range for the best performance

A	Sensing range min. in mm
B	Sensing range max. in mm
C	Field of view
D	Adjustable switching threshold for background suppression
E	Sensing range indicator
F	Teach-Turn adjustment





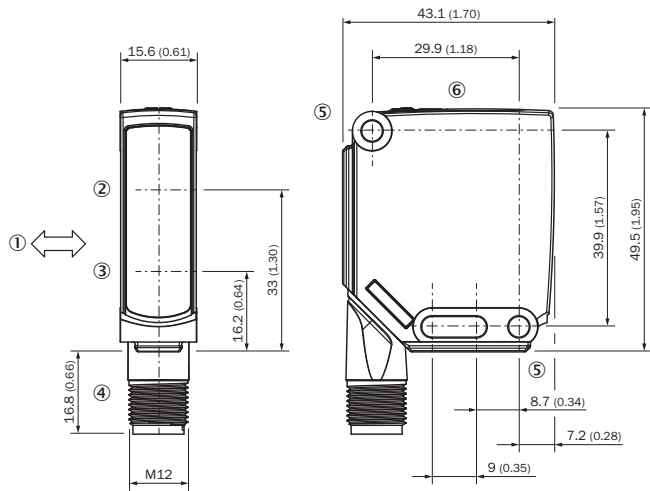

Dimensional drawing (Dimensions in mm (inch))





- ① Standard direction of the material being detected
- ② Center of optical axis, receiver
- ③ Center of optical axis, sender
- ④ Connection
- ⑤ Mounting hole,  $\varnothing$  4.2 mm
- ⑥ Display and adjustment elements

Recommended accessories

Other models and accessories → [www.sick.com/W12](http://www.sick.com/W12)

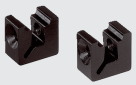
	Brief description	Type	Part no.
<b>Universal bar clamp systems</b>			
	Plate N03 for universal clamp bracket, zinc coated, Zinc plated steel (sheet), Zinc die cast (clamping bracket), Universal clamp (5322626), mounting hardware	BEF-KHS-N03	2051609
	Mounting bar, straight, 300 mm, steel, steel, zinc coated, without mounting hardware	BEF-MS12G-B	4056055
	Bar clamp for bar diameter of 12 mm (fixing the mounting rod), Aluminum, 2 screws M6 x 30, 2 spring discs	BEF-RMC-D12	5321878
<b>Mounting brackets and plates</b>			
	Mounting bracket, large, stainless steel, mounting hardware included	BEF-WG-W12	2013942
	BEF-AP-W12	BEF-AP-W12	2127742
<b>Plug connectors and cables</b>			
	<ul style="list-style-type: none"> <li>• <b>Connection type head A:</b> Female connector, M12, 4-pin, straight, A-coded</li> <li>• <b>Connection type head B:</b> Flying leads</li> <li>• <b>Signal type:</b> Sensor/actuator cable</li> <li>• <b>Cable:</b> 5 m, 4-wire, PVC</li> <li>• <b>Description:</b> Sensor/actuator cable, unshielded</li> <li>• <b>Application:</b> Zones with chemicals</li> </ul>	YF2A14-050VB3XLEAX	2096235

	Brief description	Type	Part no.
Terminal and alignment brackets			
	Clamping block for dovetail mounting, Aluminum (anodised), mounting hardware included	BEF-KH-W12	2013285
Sensor Integration Gateway			
	<ul style="list-style-type: none"> <li>• <b>Further functions:</b> Web server integrated, IIoT interface available (dual talk)</li> <li>• <b>Logic editor:</b> no</li> <li>• <b>Communication interface:</b> IO-Link, Ethernet, PROFINET, REST API, MQTT, OPC UA</li> <li>• <b>Product category:</b> IO-Link Master</li> </ul>	SIG350-0004AP100	6076871

## SICK AT A GLANCE

SICK is one of the leading manufacturers of intelligent sensors and sensor solutions for industrial applications. A unique range of products and services creates the perfect basis for controlling processes securely and efficiently, protecting individuals from accidents and preventing damage to the environment.

We have extensive experience in a wide range of industries and understand their processes and requirements. With intelligent sensors, we can deliver exactly what our customers need. In application centers in Europe, Asia and North America, system solutions are tested and optimized in accordance with customer specifications. All this makes us a reliable supplier and development partner.

Comprehensive services complete our offering: SICK LifeTime Services provide support throughout the machine life cycle and ensure safety and productivity.

For us, that is “Sensor Intelligence.”

## WORLDWIDE PRESENCE:

Contacts and other locations –[www.sick.com](http://www.sick.com)