



i110-SA223

i110S

ELECTRO-MECHANICAL SAFETY SWITCHES

SICK
Sensor Intelligence.

Ordering information



Type	Part no.
i110-SA223	6025074

The actuator has to be ordered separately. See "Accessories" for further details.

Other models and accessories → www.sick.com/i110S

actuator not supplied with delivery



Detailed technical data

Features

Number of positive action N/C contacts	2
Number of N/O contacts	2
Retaining force	≤ 12 N
Actuation frequency	≤ 7,200 /h
Actuation directions	5
Approach speed	≤ 10 m/min

Safety-related parameters

B_{10d} parameter	2 x 10 ⁶ switching cycles (with small load)
Type	Type 2 (EN ISO 14119)
Actuator coding level	Low coding level (EN ISO 14119)
Safe state in the event of a fault	The switch has no internal fault detection and is unable to assume a safe state in the event of a fault. Fault detection is performed by the connected safety-related logic unit.

Functions

Safe series connection	None, only individual wiring (with diagnostics)
-------------------------------	---

Interfaces

Connection type	Cable gland, 1 x M20
Conductor cross section	≤ 1.5 mm ²

Electrical data

Switching principle	Slow action switching element
Usage category	AC-15/DC-13 (IEC 60947-5-1)
Rated operating current (voltage)	3 A (240 V AC) 2 A (24 V DC)
Rated insulation voltage U_i	240 V
Rated impulse withstand voltage U_{imp}	2,500 V

Short-circuit protection	T10/10A
Switching voltage	≥ 5 V DC
Switching current (switching voltage)	≥ 5 mA (5 V DC)

Mechanical data

Weight	0.54 kg
Housing material	Zinc diecast
Surface treatment	Varnished
Mechanical life	1 x 10 ⁶ switching cycles

Ambient data

Enclosure rating	IP67 (IEC 60529)
Ambient operating temperature	-20 °C ... +80 °C
Storage temperature	-20 °C ... +80 °C

Classifications

eCl@ss 5.0	27272602
eCl@ss 5.1.4	27272602
eCl@ss 6.0	27272602
eCl@ss 6.2	27272602
eCl@ss 7.0	27272602
eCl@ss 8.0	27272602
eCl@ss 8.1	27272602
eCl@ss 9.0	27272602
eCl@ss 10.0	27272602
eCl@ss 11.0	27272602
eCl@ss 12.0	27272602
ETIM 5.0	EC002592
ETIM 6.0	EC002592
ETIM 7.0	EC002592
ETIM 8.0	EC002592
UNSPSC 16.0901	39122205

Dimensional drawing (Dimensions in mm (inch))

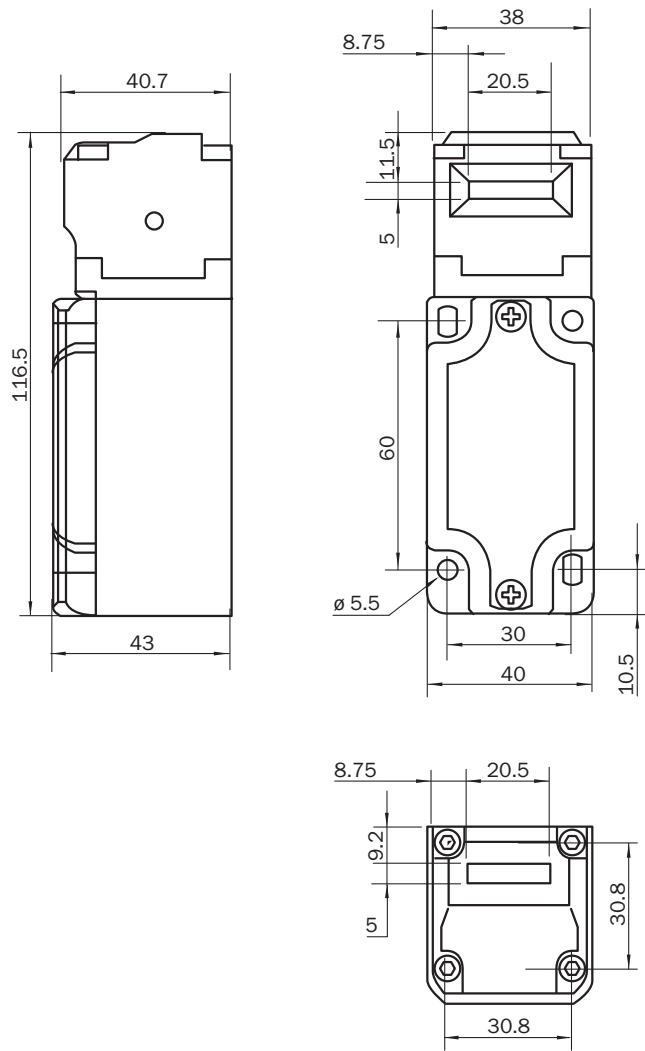



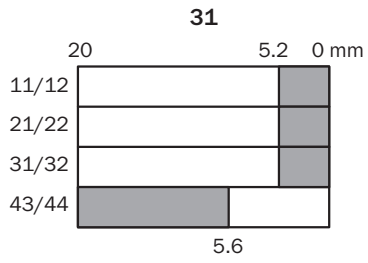
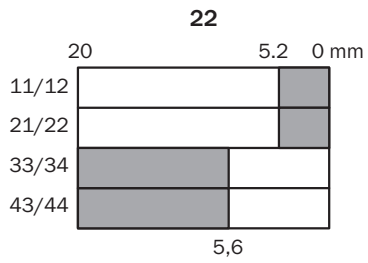

Actuator travel diagram

Contact action over the entire actuator withdrawal distance (full insertion = 0 mm)

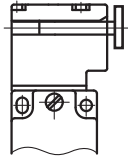
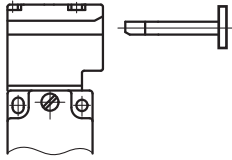

- Contacts open
- Contacts closed

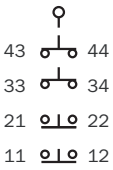
Switching elements

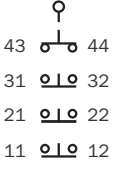
	Actuator inserted	Actuator removed
		
Switching element 22		
Switching element 31		

Switching element 22:
2 positive action N/C contacts + 2 N/O contact

Switching element 31:
3 positive action N/C contacts + 1 N/O contact

SICK AT A GLANCE

SICK is one of the leading manufacturers of intelligent sensors and sensor solutions for industrial applications. A unique range of products and services creates the perfect basis for controlling processes securely and efficiently, protecting individuals from accidents and preventing damage to the environment.

We have extensive experience in a wide range of industries and understand their processes and requirements. With intelligent sensors, we can deliver exactly what our customers need. In application centers in Europe, Asia and North America, system solutions are tested and optimized in accordance with customer specifications. All this makes us a reliable supplier and development partner.

Comprehensive services complete our offering: SICK LifeTime Services provide support throughout the machine life cycle and ensure safety and productivity.

For us, that is “Sensor Intelligence.”

WORLDWIDE PRESENCE:

Contacts and other locations –www.sick.com