

Tetra

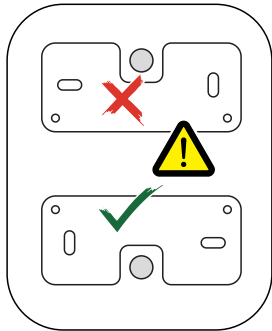

Class 3
E27

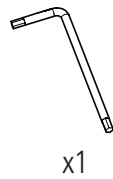
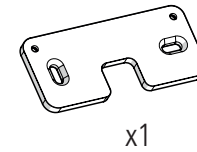

1 Traçage & perçage des trous de fixation Trace & drill the mounting holes

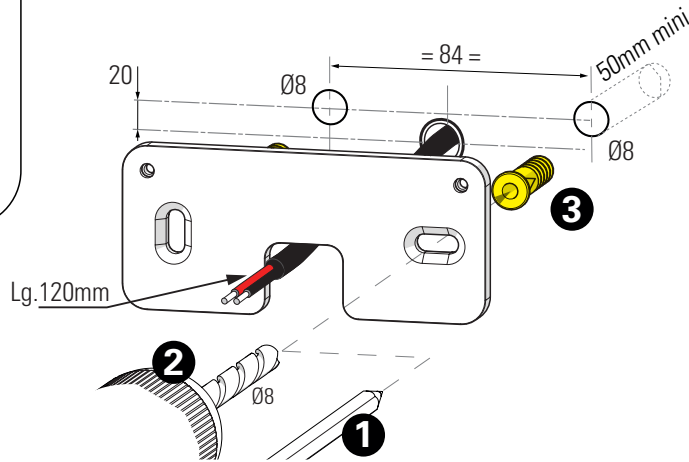

2 Fixation de la platine au mur Fix the wall-plate to the wall

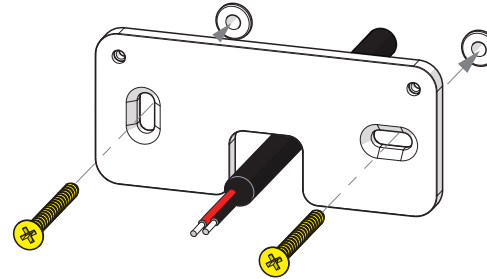

3 Retirer l'embase Remove the base

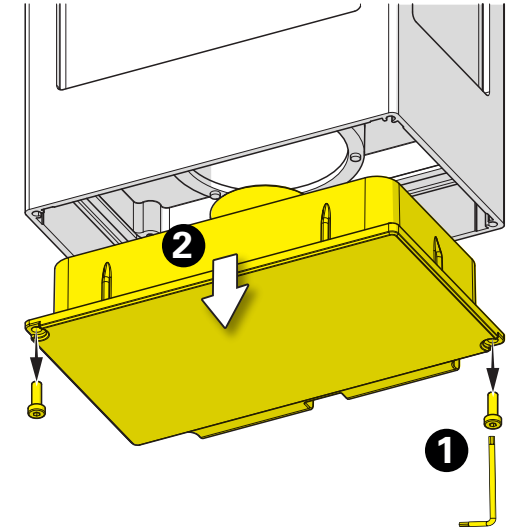

4 Fixer l'embase sur la platine Fix the base to the wall-plate

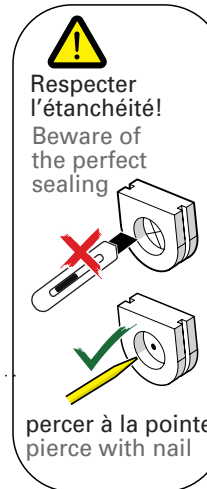
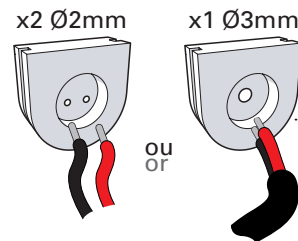
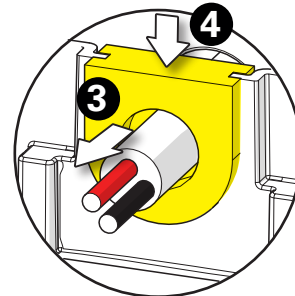
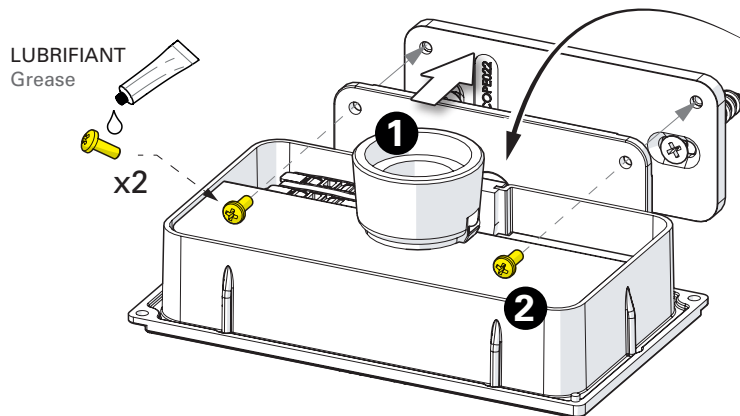

5 Raccordement électrique Connect electrical wires

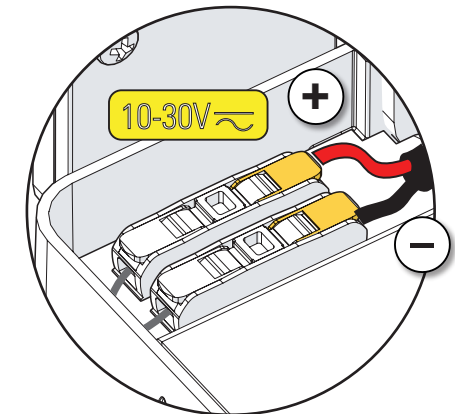

6 Montage du cadre sur l'embase
Install the frame on the base

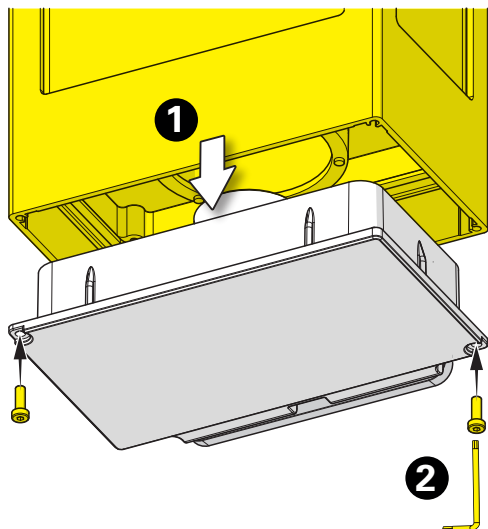

7 Retirer le couvercle supérieur
Remove the top cover

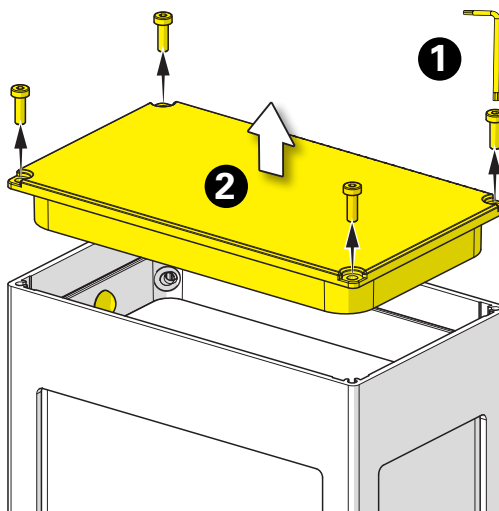

8 Extraire la plaque
Extract the plate

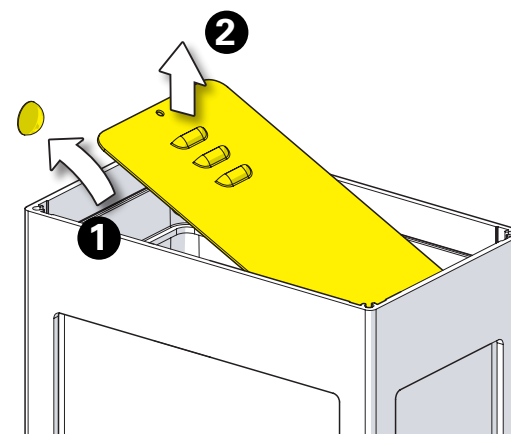

9 Montage de la lampe & du paralume
Install the light & the bulb cover

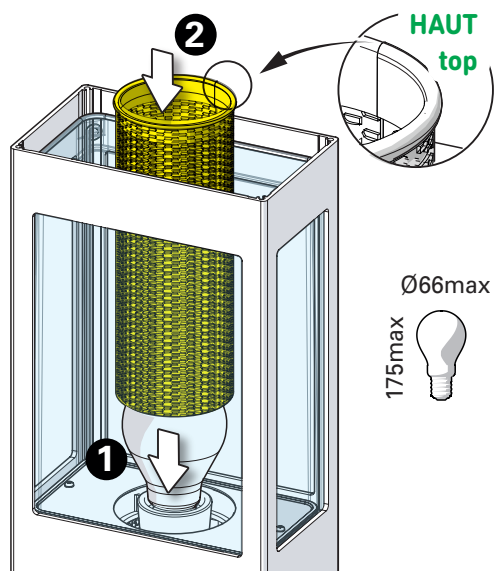

10 Remettre la plaque
Re-install the plate

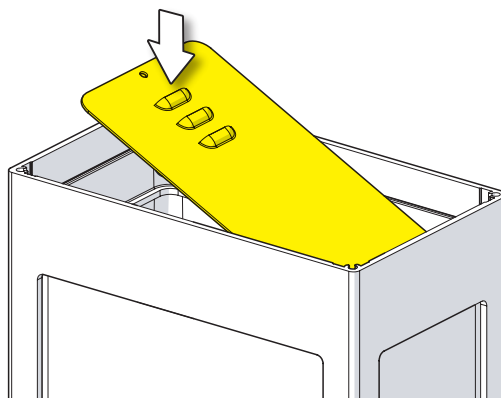

11 Remettre en place le couvercle
Put the top cover back in position

