

# DUS60E-TJKCOACA

DUS60

INCREMENTAL ENCODERS

**SICK**  
Sensor Intelligence.

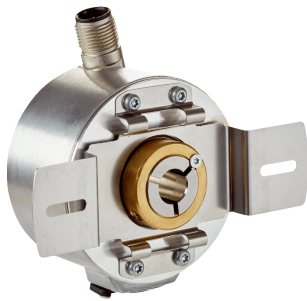

Illustration may differ



### Ordering information

| Type            | Part no. |
|-----------------|----------|
| DUS60E-TJKCOACA | 1084477  |

Other models and accessories → [www.sick.com/DUS60](http://www.sick.com/DUS60)

### Detailed technical data

#### Performance

|                                 |                                     |
|---------------------------------|-------------------------------------|
| <b>Measuring step</b>           | 90°, electric/pulses per revolution |
| <b>Measuring step deviation</b> | ± 18° / pulses per revolution       |
| <b>Error limits</b>             | Measuring step deviation x 3        |
| <b>Duty cycle</b>               | ≤ 0.5 ± 5 %                         |

#### Interfaces

|                                       |  |
|---------------------------------------|--|
| <b>Communication interface</b>        | Incremental  |
| <b>Communication Interface detail</b> | TTL / HTL <sup>1)</sup>                                  |
| <b>Parameterising data</b>            | DIP switch, selectable output                            |
| <b>Output function</b>                | A and B output   |
| <b>Initialization time</b>            | < 5 ms <sup>2)</sup>                                     |
| <b>Output frequency</b>               | + 60 kHz   |
| <b>Load current</b>                   | ≤ 30 mA, per channel                                     |
| <b>Operating current</b>              | ≤ 120 mA (without load)                                  |
| <b>Power consumption</b>              | ≤ 1.25 W (without load)                                  |
| <b>DIP switch parameters</b>          |  |
| Pulses per revolution                 | ✓  |
| Output voltage                        | ✓  |
| Direction of rotation                 | ✓  |
| Configuration switches                | 1800 PPR values, direction selection, TTL/HTL selectable |

<sup>1)</sup> The output is not selectable for DIP switch configurations E, F, and G. The output voltage value is dependent on the supply voltage.

<sup>2)</sup> Valid positional data can be read once this time has elapsed.

#### Electrical data

|                        |   |
|------------------------|---|
| <b>Connection type</b> | Male connector, M12, 8-pin, universal <sup>1)</sup> |
| <b>Supply voltage</b>  | 4.75 ... 30 V                                       |

<sup>1)</sup> The universal connection is rotatable so that it is possible to position the connector in the radial or axial direction.

<sup>2)</sup> This product is a standard product and does not constitute a safety component as defined in the Machinery Directive. Calculation based on nominal load of components, average ambient temperature 40°C, frequency of use 8760 h/a. All electronic failures are considered hazardous. For more information, see document no. 8015532.

|  |  |
|--|--|
| <b>Reference signal, number</b>                | 1  |
| <b>Reference signal, position</b>              | 180°, electric, gated with A             |
| <b>Reverse polarity protection</b>             | ✓  |
| <b>Short-circuit protection of the outputs</b> | ✓  |
| <b>MTTFd: mean time to dangerous failure</b>   | 275 years (EN ISO 13849-1) <sup>2)</sup> |

<sup>1)</sup> The universal connection is rotatable so that it is possible to position the connector in the radial or axial direction.

<sup>2)</sup> This product is a standard product and does not constitute a safety component as defined in the Machinery Directive. Calculation based on nominal load of components, average ambient temperature 40 °C, frequency of use 8760 h/a. All electronic failures are considered hazardous. For more information, see document no. 8015532.

## Mechanical data

|                                       |  |
|---------------------------------------|--|
| <b>Mechanical design</b>              | Through hollow shaft, Front clamp                          |
| <b>Shaft diameter</b>                 | 5/8"   |
| <b>Flange type / stator coupling</b>  | 2-point stator coupling, slot, hole diameter 63 mm – 83 mm |
| <b>Weight</b>                         | 0.25 kg <sup>1)</sup>                                      |
| <b>Shaft material</b>                 | Stainless steel  |
| <b>Flange material</b>                | Aluminum   |
| <b>Housing material</b>               | Aluminum   |
| <b>Material, cable</b>                | PVC  |
| <b>Start up torque</b>                | 0.5 Ncm (+20 °C)   |
| <b>Operating torque</b>               | 0.4 Ncm (+20 °C)   |
| <b>Permissible movement static</b>    | ± 0.3 mm (radial)<br>± 0.5 mm (axial)                      |
| <b>Permissible movement dynamic</b>   | ± 0.1 mm (radial)<br>± 0.2 mm (axial)                      |
| <b>Operating speed</b>                | 1,500 min <sup>-1</sup>                                    |
| <b>Moment of inertia of the rotor</b> | 50 gcm <sup>2</sup>  |
| <b>Bearing lifetime</b>               | 3.6 x 10 <sup>9</sup> revolutions                          |
| <b>Angular acceleration</b>           | ≤ 500,000 rad/s <sup>2</sup>                               |

<sup>1)</sup> Based on encoder with male connector.

## Ambient data

|                                      |  |
|--------------------------------------|--|
| <b>EMC</b>                           | According to EN 61000-6-2 and EN 61000-6-3 |
| <b>Enclosure rating</b>              | IP65 <sup>1)</sup>                         |
| <b>Permissible relative humidity</b> | 90 % (Condensation not permitted)          |
| <b>Operating temperature range</b>   | -30 °C ... +90 °C                          |
| <b>Storage temperature range</b>     | -40 °C ... +75 °C                          |
| <b>Resistance to shocks</b>          | 100 g (EN 60068-2-27)                      |
| <b>Resistance to vibration</b>       | 30 g, 10 Hz ... 2,000 Hz (EN 60068-2-6)    |

<sup>1)</sup> When the mating connector is installed and the DIP switch door is sealed with the encoder housing.

## Classifications

|                     |          |
|---------------------|----------|
| <b>eCl@ss 5.0</b>   | 27270501 |
| <b>eCl@ss 5.1.4</b> | 27270501 |
| <b>eCl@ss 6.0</b>   | 27270590 |

|                       |          |
|-----------------------|----------|
| <b>eCl@ss 6.2</b>     | 27270590 |
| <b>eCl@ss 7.0</b>     | 27270501 |
| <b>eCl@ss 8.0</b>     | 27270501 |
| <b>eCl@ss 8.1</b>     | 27270501 |
| <b>eCl@ss 9.0</b>     | 27270501 |
| <b>eCl@ss 10.0</b>    | 27270501 |
| <b>eCl@ss 11.0</b>    | 27270501 |
| <b>eCl@ss 12.0</b>    | 27270501 |
| <b>ETIM 5.0</b>       | EC001486 |
| <b>ETIM 6.0</b>       | EC001486 |
| <b>ETIM 7.0</b>       | EC001486 |
| <b>ETIM 8.0</b>       | EC001486 |
| <b>UNSPSC 16.0901</b> | 41112113 |

### Dimensional drawing (Dimensions in mm (inch))

Through hollow shaft with front clamping

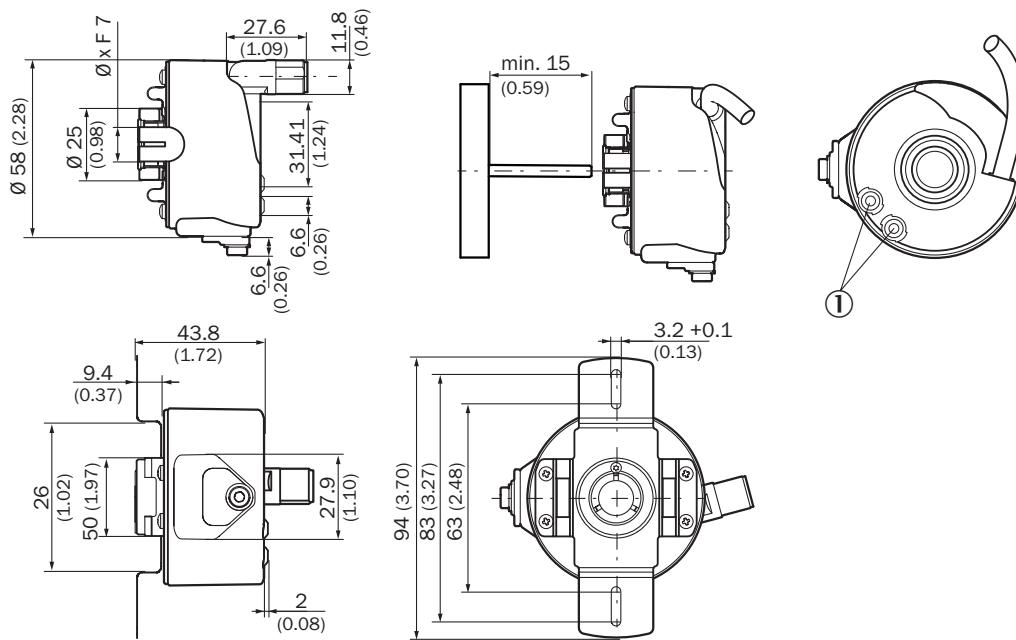

① Status indicators

## PIN assignment

View of M12 male device connector on encoder



| Wire colors (cable connection) | Male connector M12, 4-pin | Male connector M12, 8-pin | Output function |                |                |   | Explanation            |
|--------------------------------|---------------------------|---------------------------|-----------------|----------------|----------------|---|------------------------|
|                                |                           |                           | A               | B              | C              | D   |                        |
| Brown                          | -                         | 1                         | A-              | CW-            | A-             | A-  | Signal                 |
| White                          | 4                         | 2                         | A               | CW             | A              | A   | Signal                 |
| Black                          | -                         | 3                         | B-              | CCW-           | Direction-     | B-  | Signal                 |
| Pink                           | 2                         | 4                         | B               | CCW            | Direction      | Fault (M12, 4-pin)<br>B (M12, 8-pin and cable connection) | Signal                 |
| Yellow                         | -                         | 5                         | Z-              | Fault-         | Fault-         | Fault-  | Signal                 |
| Violet                         | -                         | 6                         | Z               | Fault          | Fault          | Fault   | Signal                 |
| Blue                           | 3                         | 7                         | GND             | GND            | GND            | GND   | Ground connection      |
| Red                            | 1                         | 8                         | U <sub>S</sub>  | U <sub>S</sub> | U <sub>S</sub> | U <sub>S</sub>  | Supply voltage         |
| -                              | -                         | -                         | Case            | Case           | Case           | Case  | Earth fault protection |
| Shielding                      | -                         | -                         | Shielding       | Shielding      | Shielding      | Shielding   | Shielding              |

## Adjustments

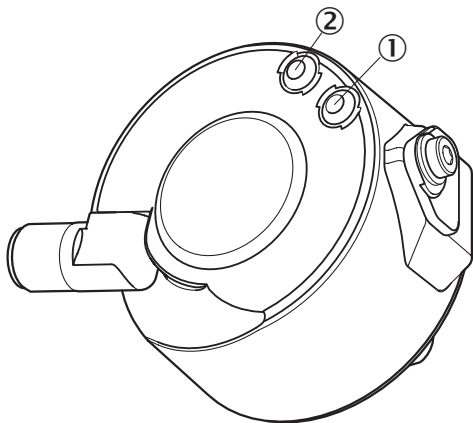













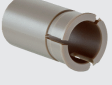

|                       | DIP switch configuration C – 1800 pulses |    |    |     |      |
|-----------------------|--|----|----|-----|------|
| Pulses per revolution | 1  | 9  | 30 | 120 | 600  |
|                       | 2  | 10 | 36 | 150 | 900  |
|                       | 3  | 12 | 40 | 180 | 1800 |

| DIP switch configuration C – 1800 pulses |   |    |     |     |  |
|--|---|----|-----|-----|--|
|  | 4 | 15 | 60  | 200 |  |
|  | 5 | 18 | 72  | 300 |  |
|  | 6 | 20 | 75  | 360 |  |
|  | 8 | 24 | 100 | 450 |  |

### Recommended accessories

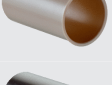
Other models and accessories → [www.sick.com/DUS60](http://www.sick.com/DUS60)

|   | Brief description   | Type              | Part no. |
|---|---|-------------------|----------|
| <b>Plug connectors and cables</b>   |   |                   |          |
|    | Head A: female connector, M12, 8-pin, straight<br>Head B: Flying leads<br>Cable: Incremental, SSI, PUR, halogen-free, shielded, 2 m       | DOL-1208-G02MAC1  | 6032866  |
|   | Head A: female connector, M12, 8-pin, straight<br>Head B: Flying leads<br>Cable: Incremental, SSI, PUR, halogen-free, shielded, 5 m       | DOL-1208-G05MAC1  | 6032867  |
|   | Head A: female connector, M12, 8-pin, straight<br>Head B: Flying leads<br>Cable: Incremental, SSI, PUR, halogen-free, shielded, 10 m      | DOL-1208-G10MAC1  | 6032868  |
|   | Head A: female connector, M12, 8-pin, straight<br>Head B: Flying leads<br>Cable: Incremental, SSI, PUR, halogen-free, shielded, 20 m      | DOL-1208-G20MAC1  | 6032869  |
|  | Head A: female connector, M12, 8-pin, angled<br>Head B: Flying leads<br>Cable: PVC, shielded, 2 m   | DOL-1208-W02MA    | 6020992  |
|   | Head A: female connector, M12, 8-pin, angled<br>Head B: Flying leads<br>Cable: HIPERFACE®, Incremental, PUR, halogen-free, shielded, 2 m  | DOL-1208-W02MAC1  | 6037724  |
|  | Head A: female connector, M12, 8-pin, angled<br>Head B: Flying leads<br>Cable: Sensor/actuator cable, PUR, halogen-free, shielded, 2 m    | DOL-1208-W02MAS01 | 6029224  |
|  | Head A: female connector, M12, 8-pin, angled<br>Head B: Flying leads<br>Cable: PUR, halogen-free, unshielded, 2 m                         | DOL-1208-W02MC    | 6035623  |
|  | Head A: female connector, M12, 8-pin, angled<br>Head B: Flying leads<br>Cable: PVC, shielded, 5 m   | DOL-1208-W05MA    | 6021033  |
|   | Head A: female connector, M12, 8-pin, angled<br>Head B: Flying leads<br>Cable: HIPERFACE®, Incremental, PUR, halogen-free, shielded, 5 m  | DOL-1208-W05MAC1  | 6037725  |
|  | Head A: female connector, M12, 8-pin, angled<br>Head B: Flying leads<br>Cable: PUR, unshielded, 5 m                                       | DOL-1208-W05MC    | 6035624  |
|  | Head A: female connector, M12, 8-pin, angled<br>Head B: Flying leads<br>Cable: HIPERFACE®, Incremental, PUR, halogen-free, shielded, 10 m | DOL-1208-W10MAC1  | 6037726  |

|   | <b>Brief description</b>  | <b>Type</b>      | <b>Part no.</b> |
|---|---|------------------|-----------------|
|    | Head A: female connector, M12, 8-pin, angled<br>Head B: Flying leads<br>Cable: PUR, halogen-free, unshielded, 10 m          | DOL-1208-W10MC   | 6035625         |
|    | Head A: female connector, M12, 8-pin, angled<br>Head B: Flying leads<br>Cable: HIPERFACE®, Incremental, PUR, shielded, 20 m | DOL-1208-W20MAC1 | 6037727         |
|    | Head A: female connector, M12, 8-pin, straight, A-coded<br>Cable: Incremental, SSI, shielded                                | DOS-1208-GA01    | 6045001         |
| <b>Shaft adaptation</b>   |   |                  |                 |
|   | Collet plastic insulated for hollow shaft, shaft diameter 6 mm, outer diameter 5/8" (15.875 mm), plastic                    | SPZ-58Z-006-P    | 2076228         |
|   | Collet metal for hollow shaft, shaft diameter 8 mm, outer diameter 5/8" (15.875 mm), metal                                  | SPZ-58Z-008-M    | 2076219         |
|   | Collet plastic insulated for hollow shaft, shaft diameter 8 mm, outer diameter 5/8" (15.875 mm), plastic                    | SPZ-58Z-008-P    | 2076229         |
|   | Collet metal for hollow shaft, shaft diameter 10 mm, outer diameter 5/8" (15.875 mm), metal                                 | SPZ-58Z-010-M    | 2076220         |
|    | Collet plastic insulated for hollow shaft, shaft diameter 10 mm, outer diameter 5/8" (15.875 mm), plastic                   | SPZ-58Z-010-P    | 2076230         |
|   | Collet metal for hollow shaft, shaft diameter 12 mm, outer diameter 5/8" (15.875 mm), metal                                 | SPZ-58Z-012-M    | 2076221         |
|   | Collet plastic insulated for hollow shaft, shaft diameter 12 mm, outer diameter 5/8" (15.875 mm), plastic                   | SPZ-58Z-012-P    | 2076231         |
|   | Collet metal for hollow shaft, shaft diameter 14 mm, outer diameter 5/8" (15.875 mm), metal                                 | SPZ-58Z-014-M    | 2076222         |
|   | Collet plastic insulated for hollow shaft, shaft diameter 14 mm, outer diameter 5/8" (15.875 mm), plastic                   | SPZ-58Z-014-P    | 2076232         |
|   | Collet metal for hollow shaft, shaft diameter 15 mm, outer diameter 5/8" (15.875 mm), metal                                 | SPZ-58Z-015-M    | 2076223         |
|   | Collet plastic insulated for hollow shaft, shaft diameter 15 mm, outer diameter 5/8" (15.875 mm), plastic                   | SPZ-58Z-015-P    | 2076233         |
|  | Collet metal for hollow shaft, shaft diameter 1/2" (12.7 mm), outer diameter 5/8" (15.875 mm), metal                        | SPZ-58Z-12Z-M    | 2076225         |
|   | Collet plastic insulated for hollow shaft, shaft diameter 1/2" (12.7 mm), outer diameter 5/8" (15.875 mm), plastic          | SPZ-58Z-12Z-P    | 2076227         |
|   | Collet metal for hollow shaft, shaft diameter 3/8" (9.525 mm), outer diameter 5/8" (15.875 mm), metal                       | SPZ-58Z-38Z-M    | 2076224         |

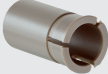
|   | Brief description   | Type          | Part no. |
|---|---|---------------|----------|
|  | Collet plastic insulated for hollow shaft, shaft diameter 3/8" (9.525 mm), outer diameter 5/8" (15.875 mm), plastic | SPZ-58Z-38Z-P | 2076226  |



## SICK AT A GLANCE

SICK is one of the leading manufacturers of intelligent sensors and sensor solutions for industrial applications. A unique range of products and services creates the perfect basis for controlling processes securely and efficiently, protecting individuals from accidents and preventing damage to the environment.

We have extensive experience in a wide range of industries and understand their processes and requirements. With intelligent sensors, we can deliver exactly what our customers need. In application centers in Europe, Asia and North America, system solutions are tested and optimized in accordance with customer specifications. All this makes us a reliable supplier and development partner.

Comprehensive services complete our offering: SICK LifeTime Services provide support throughout the machine life cycle and ensure safety and productivity.

For us, that is “Sensor Intelligence.”

## WORLDWIDE PRESENCE:

Contacts and other locations –[www.sick.com](http://www.sick.com)