



Product designation				Power contactor
Product type designation				BF38
Contact characteristics				
Number of poles	Nr.			4
Rated insulation voltage U _i IEC/EN	V			690
Rated impulse withstand voltage U _{imp}	kV			6
Operational frequency	min	Hz		25
	max	Hz		400
IEC Conventional free air thermal current I _{th}	A			56
Operational current I _e	AC-1 (≤40°C)	A		56
	AC-1 (≤40°C) with 16mm ² wire and fork end lug	A		60
	AC-1 (≤55°C)	A		45
	AC-1 (≤55°C) with 16mm ² wire and fork end lug	A		48
	AC-1 (≤70°C)	A		40
	AC-1 (≤70°C) with 16mm ² wire and fork end lug	A		42
	AC-3 (≤440V ≤55°C)	A		38
Rated operational power AC-1 (T≤40°C)	AC-4 (400V)	A		15.5
	230V	kW		21
	400V	kW		36
	500V	kW		45
	690V	kW		62
Short-time allowable current for 10s (IEC/EN60947-1)	A			320
Protection fuse	gG (IEC)	A		63
	aM (IEC)	A		40
Making capacity (RMS value)	A			380
Breaking capacity at voltage	440V	A		304
	500V	A		240
	690V	A		192
Resistance per pole (average value)		mΩ		2
Power dissipation per pole (average value)	I _{th}	W		6
	AC-3	W		2.9
Tightening torque for terminals	min	Nm		2.5
	max	Nm		3
	min	I _{bin}		1.8
	max	I _{bin}		2.2
Tightening torque for coil terminal	min	Nm		0.8
	max	Nm		1

	min	I _{bin}	0.8
	max	I _{bin}	0.74
Max number of wires simultaneously connectable		Nr.	2
Conductor section			
AWG/Kcmil			
	max		6
Flexible w/o lug conductor section			
	min	mm ²	2.5
	max	mm ²	16
Flexible c/w lug conductor section			
	min	mm ²	1
	max	mm ²	10
Flexible with insulated spade lug conductor section			
	min	mm ²	1
	max	mm ²	10
Power terminal protection according to IEC/EN 60529			IP20 when properly wired
Mechanical features			
Operating position		normal allowable	Vertical plan ±30°
Fixing			Screw / DIN rail 35mm
Weight		g	514
Conductor section			
AWG/kcmil conductor section			
	max		6
Operations			
Mechanical life		cycles	20000000
Electrical life		cycles	1400000
Safety related data			
Performance level B10d according to EN/ISO 13489-1			
	rated load	cycles	1400000
	mechanical load	cycles	20000000
Mirror contacts according to IEC/EN 60947-4-1			YES
EMC compatibility			yes
AC coil operating			
Rated AC voltage at 50/60Hz		V	48
AC operating voltage			
of 50/60Hz coil powered at 50Hz			
pick-up	min	%Us	80
	max	%Us	110
drop-out	min	%Us	20
	max	%Us	55
of 50/60Hz coil powered at 60Hz			
pick-up	min	%Us	85
	max	%Us	110
drop-out	min	%Us	20
	max	%Us	55
AC average coil consumption at 20°C			

of 50/60Hz coil powered at 50Hz

in-rush	VA	75
holding	VA	9

of 50/60Hz coil powered at 60Hz

in-rush	VA	70
holding	VA	6.5

of 60Hz coil powered at 60Hz

in-rush	VA	75
holding	VA	9

Dissipation at holding ≤20°C 50Hz	W	2.5
-----------------------------------	---	-----

Max cycles frequency

Mechanical operation	cycles/h	3600
----------------------	----------	------

Operating times

Average time for Us control

in AC

Closing NO

min	ms	8
max	ms	24

Opening NO

min	ms	5
max	ms	15

Closing NC

min	ms	11
max	ms	29

Opening NC

min	ms	6
max	ms	14

UL technical data

Full-load current (FLA) for three-phase AC motor

at 480V	A	40
at 600V	A	32

Yielded mechanical performance

for single-phase AC motor

110/120V	HP	3
230V	HP	7.5

for three-phase AC motor

200/208V	HP	10
220/230V	HP	15
460/480V	HP	30
575/600V	HP	30

General USE

Contactor

AC current	A	55
------------	---	----

Ambient conditions

Temperature

Operating temperature

min	°C	-50
max	°C	70

Storage temperature

min	°C	-60
max	°C	80

Max altitude

m	3000
---	------

Resistance & Protection

Pollution degree

3

Dimensions

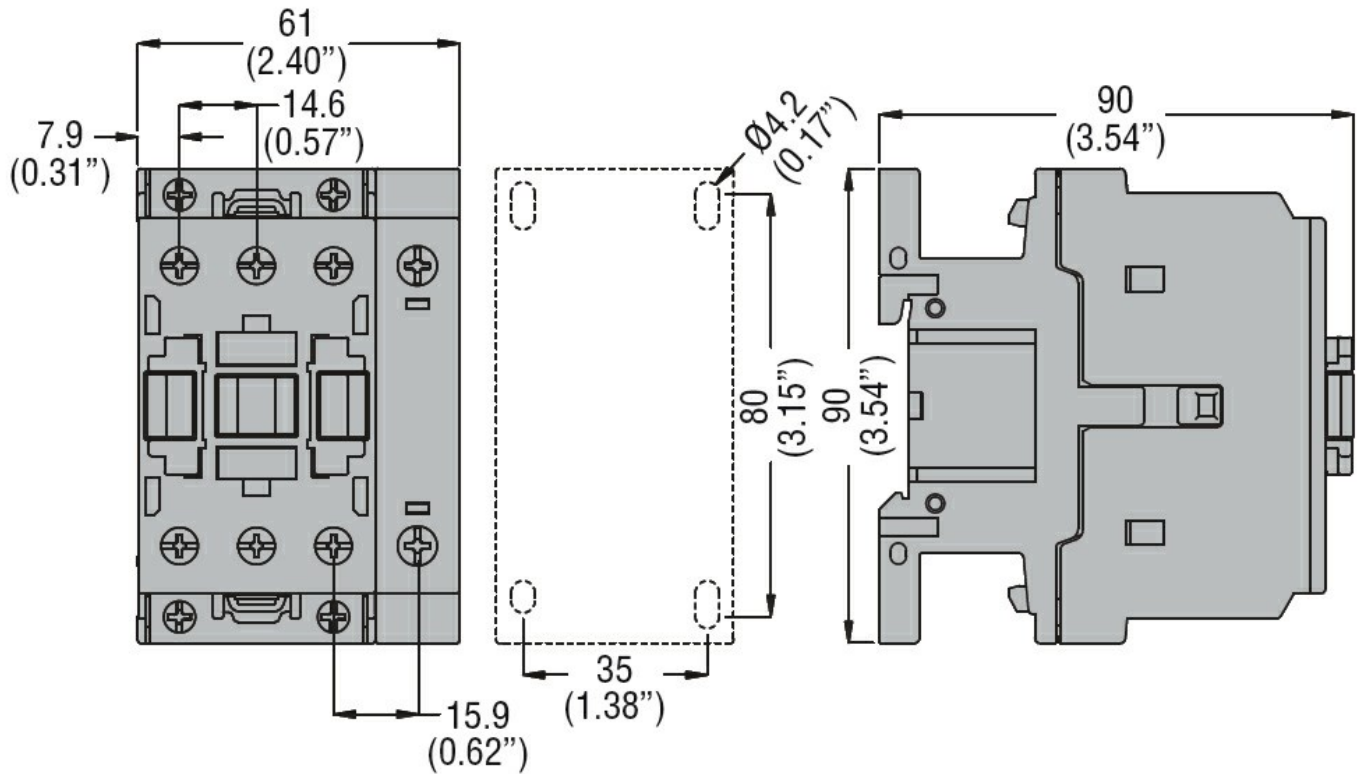

Wiring diagrams

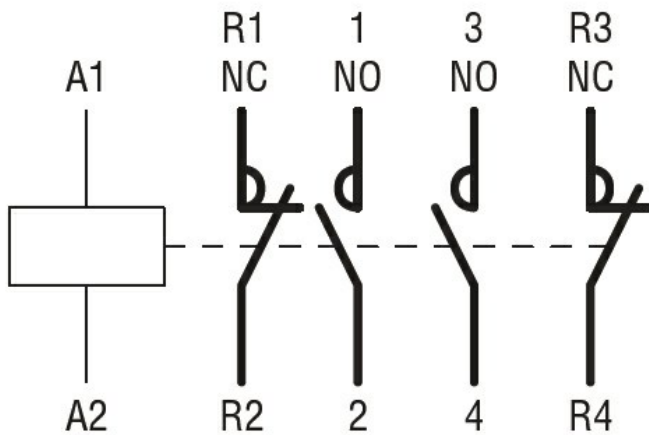

Certifications and compliance

Compliance

CSA C22.2 n° 60947-1
 CSA C22.2 n° 60947-4-1
 IEC/EN/BS 60947-1
 IEC/EN/BS 60947-4-1
 UL 60947-1
 UL 60947-4-1

Certificates

CCC
 cULus
 EAC

ETIM classification

ETIM 8.0

EC000066 -
Power contactor,
AC switching