



LBV321-XXTGCTKMX05200

LBV301

VIBRATING LEVEL SWITCH

SICK
Sensor Intelligence.



Illustration may differ



Ordering information

Type	Part no.
LBV321-XXTGCTKMX05200	6065606

Other models and accessories → www.sick.com/LBV301

Detailed technical data

Features

Medium	Bulk solids
Measurement	Switch
Probe length	5,200 mm
Process pressure	-1 bar ... 6 bar
Process temperature	-20 °C ... +80 °C
Fill material density	≥ 0.02 g/cm ³
Tensile strength	≤ 3,000 N

Performance

Accuracy of sensor element	± 10 mm
Reproducibility	≤ 5 mm
Response time	500 ms when covered / 1,000 ms when uncovered
MTBF	4,17*10 ⁶ h

Electronics

Residual ripple	≤ 5 V _{pp}
Power consumption	< 10 mA
Initialization time	< 2 s
VDE protection class 2	✓
Connection type	M20 x 1.5
Output signal	1 x PNP/NPN
Supply voltage	Volt-free transistor output PNP/ NPN: 10 V DC ... 55 V DC
Hysteresis	10 mm
Output current	< 300 mA
Inductive load	1 H
Capacitive load	100 nF
Enclosure rating	IP66 / IP67

Mechanics

Process connection	G 1 A
---------------------------	-------

Housing material	Plastic
Sensor material	Stainless steel 316L, 318S, PUR, FEB

Ambient data

Ambient operating temperature	-40 °C ... +70 °C
Ambient temperature, storage	-40 °C ... +80 °C

Classifications

ECLASS 5.0	27273202
ECLASS 5.1.4	27273202
ECLASS 6.0	27273202
ECLASS 6.2	27273202
ECLASS 7.0	27273202
ECLASS 8.0	27273202
ECLASS 8.1	27273202
ECLASS 9.0	27273202
ECLASS 10.0	27273202
ECLASS 11.0	27273202
ECLASS 12.0	27273106
ETIM 5.0	EC002654
ETIM 6.0	EC002654
ETIM 7.0	EC002654
ETIM 8.0	EC002654
UNSPSC 16.0901	41111938

Type code

LBV321 type code

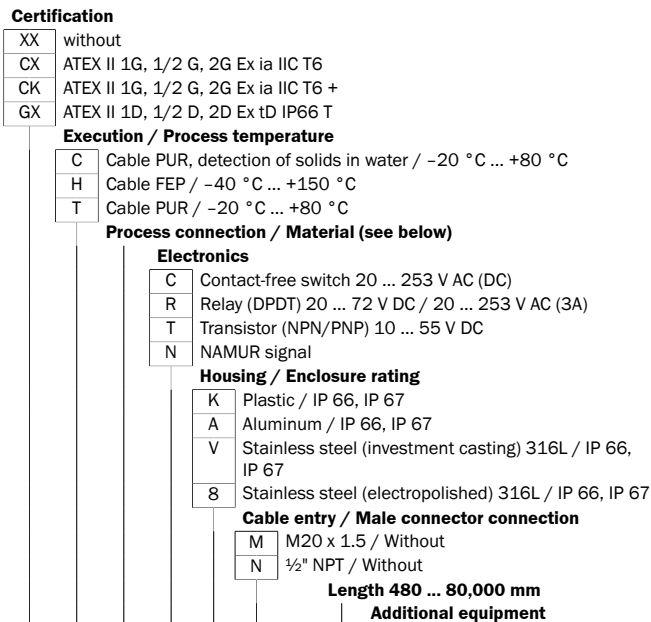

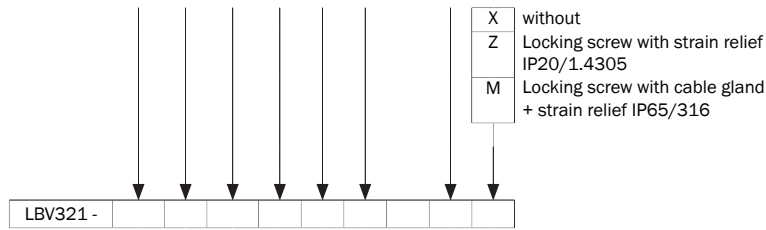

Not all variants of the type code can be combined!

Process connection / Material

XP	Without / 316L, Ra < 0.8 µm	3F	Flange DN 125, PN 6, form C, DIN 2501 / 316L
GC	Thread G 1, DIN 3852-A, PN 6 / 316L	QF	Flange DN 150, PN 16, form C, DIN 2501 / 316L
GR	Thread G 1, DIN 3852-A, PN 6 / 316L, Ra < 0.8 µm	2F	Flange DN 200, PN 10, form C, DIN 2501 / 316L
GD	Thread G 1 ½, DIN 3852-A, PN 16 / 316L	EB	Flange DN 50, PN 40, EN 1092-1, form B1 / 316L
GT	Thread G 1 ½, DIN 3852-A, PN 16 / 316L, Ra < 0.8 µm	DA	Flange 1 ½", 150 lb RF, ANSI B16.5 / 316L
NC	Thread 1" NPT, ASME B1.20.1, PN 6 / 316L	EA	Flange 1 ½", 300 lb RF, ANSI B16.5 / 316L
NR	Thread 1" NPT, ASME B1.20.1, PN 6 / 316L, Ra < 0.8 µm	HA	Flange 2", 150 lb RF, ANSI B16.5 / 316L
NH	Thread 1 ¼" NPT, ASME B1.20.1, PN 6 / 316L	IA	Flange 2", 300 lb RF, ANSI B16.5 / 316L
NI	Thread 1 ¼" NPT, ASME B1.20.1, PN 6 / 316L, Ra < 0.8 µm	OA	Flange 3", 150 lb RF, ANSI B16.5 / 316L
ND	Thread 1 ½" NPT, ASME B1.20.1, PN 16 / 316L	OE	Flange 3", 150 lb RF, ANSI B16.5 / 316L
NT	Thread 1 ½" NPT, ASME B1.20.1, PN 16 / 316L, Ra < 0.8 µm	PA	Flange 3", 300 lb RF, ANSI B16.5 / 316L
BF	Flange DN 32, PN 40, form C, DIN 2501 / 316L	PE	Flange 3", 300 lb RF, ANSI B16.5 / 316L
DF	Flange DN 40, PN 40, form C, DIN 2501 / 316L	JA	Flange 3 ½", 150 lb RF, ANSI B16.5 / 316L
EF	Flange DN 50, PN 40, form C, DIN 2501 / 316L	SA	Flange 4", 150 lb RF, ANSI B16.5 / 316L
4F	Flange DN 65, PN 16, form C, DIN 2501 / 316L	UA	Flange 4", 300 lb RF, ANSI B16.5 / 316L
No error	Flange DN 80, PN 40, form C, DIN 2501 / 316L	AU	Flange DN 50, 10K RF, JIS / 316L
ZF	Flange DN 100, PN 6, form C, DIN 2501 / 316L	HU	Flange DN 65, 10K RF, JIS / 316L
MF	Flange DN 100, PN 16, form C, DIN 2501 / 316L	BU	Flange DN 80, 10K RF, JIS / 316L
OF	Flange DN 100, PN 40, form C, DIN 2501 / 316L	CU	Flange DN 100, 10K RF, JIS / 316L

Dimensional drawing (Dimensions in mm (inch))

LBV321 threaded version G 1 1/2 A

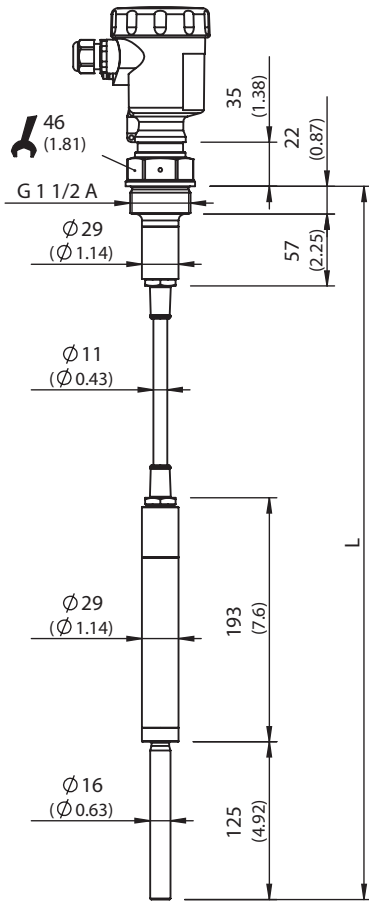

All dimensions in mm (inch)

LBV321 threaded version G 1 A

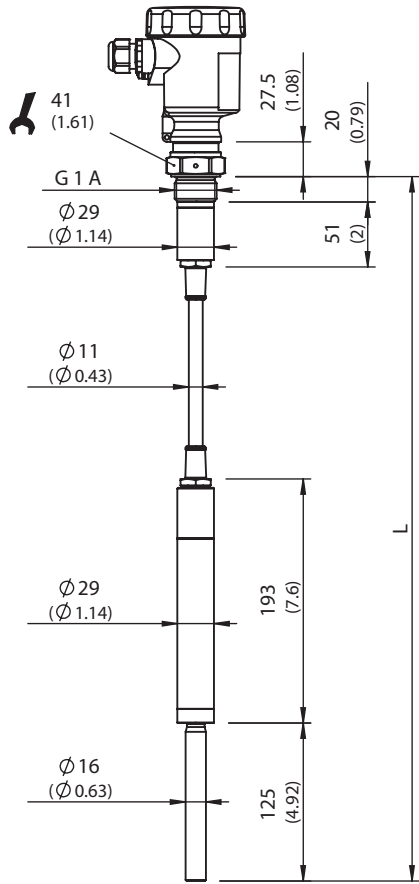

All dimensions in mm (inch)

Connection diagram

PNP action

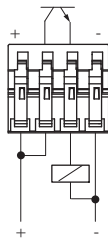

NPN action

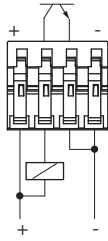

Transistor connection diagram

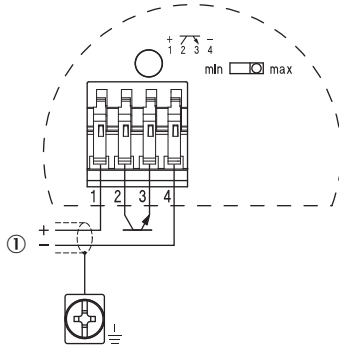

Instruction for installation

Horizontal mounting

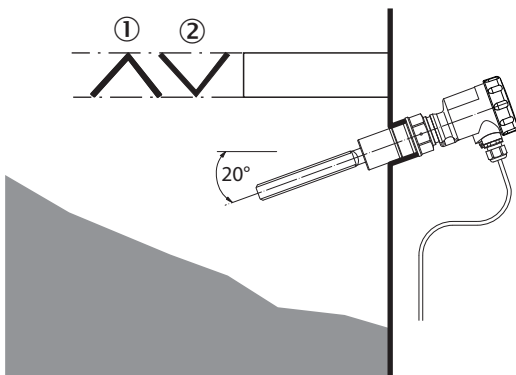

- ① Protective sheet
- ② Concave protective sheet for abrasive solids

Characteristic curve

Ambient temperature - process temperature

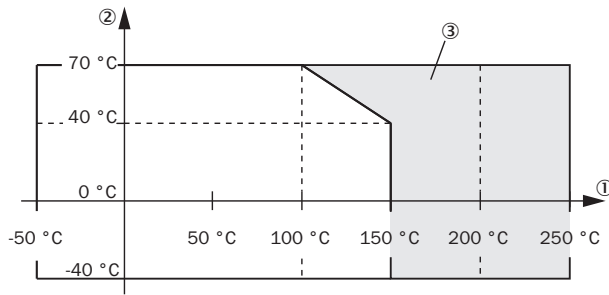

- ① Process temperature in °C (°F)
- ② Ambient temperature in °C (°F)
- ③ Temperature range with temperature adapter

SICK AT A GLANCE

SICK is one of the leading manufacturers of intelligent sensors and sensor solutions for industrial applications. A unique range of products and services creates the perfect basis for controlling processes securely and efficiently, protecting individuals from accidents and preventing damage to the environment.

We have extensive experience in a wide range of industries and understand their processes and requirements. With intelligent sensors, we can deliver exactly what our customers need. In application centers in Europe, Asia and North America, system solutions are tested and optimized in accordance with customer specifications. All this makes us a reliable supplier and development partner.

Comprehensive services complete our offering: SICK LifeTime Services provide support throughout the machine life cycle and ensure safety and productivity.

For us, that is “Sensor Intelligence.”

WORLDWIDE PRESENCE:

Contacts and other locations –www.sick.com