



# ZLD18-2AB4B2P37

Z18 Simple Sense

HYBRID PHOTOELECTRIC SENSORS

**SICK**  
Sensor Intelligence.



Illustration may differ



### Ordering information

| Type            | Part no. |
|-----------------|----------|
| ZLD18-2AB4B2P37 | 1103575  |

Other models and accessories → [www.sick.com/Z18\\_Simple\\_Sense](http://www.sick.com/Z18_Simple_Sense)

### Detailed technical data

#### Features

|  |                                       |
|--|---------------------------------------|
| <b>Functional principle</b>            | Photoelectric retro-reflective sensor |
| <b>Functional principle detail</b>     | Dual lens                             |
| <b>Dimensions (W x H x D)</b>          | 13.6 mm x 34.8 mm x 21.9 mm           |
| <b>Housing design (light emission)</b> | Hybrid                                |
| <b>Thread diameter (housing)</b>       | M18                                   |
| <b>Mounting system type</b>            | M18, head/side (24.1 ... 25.4 mm)     |
| <b>Housing color</b>                   | Blue                                  |
| <b>Sensing range max.</b>              | 0 m ... 7.8 m <sup>1)</sup>           |
| <b>Sensing range</b>                   | 0 m ... 6.8 m <sup>1)</sup>           |
| <b>Type of light</b>                   | Visible red light                     |
| <b>Light source</b>                    | PinPoint LED                          |
| <b>Light spot size (distance)</b>      | Ø 25 mm (1,000 mm)                    |
| <b>Wave length</b>                     | 625 nm                                |

<sup>1)</sup> Reflector PL80A.

#### Mechanics/electronics

|                                     |                                 |
|-------------------------------------|---------------------------------|
| <b>Supply voltage U<sub>B</sub></b> | 10 V DC ... 30 V DC             |
| <b>Ripple</b>                       | < 10 %                          |
| <b>Current consumption</b>          | ≤ 15 mA <sup>1)</sup>           |
| <b>Switching output</b>             | Push-pull: PNP/NPN              |
| <b>Switching mode</b>               | Light switching, Dark switching |

<sup>1)</sup> Without load.

<sup>2)</sup> Signal transit time with resistive load.

<sup>3)</sup> With light/dark ratio 1:1.

<sup>4)</sup> A = V<sub>S</sub> connections reverse-polarity protected.

<sup>5)</sup> B = inputs and output reverse-polarity protected.

<sup>6)</sup> D = outputs overcurrent and short-circuit protected.

|                                       |   |
|---------------------------------------|---|
| <b>Switching output detail</b>        |   |
| Switching output Q1                   | Push-pull: PNP/NPN, Light switching                   |
| Switching output Q2                   | Push-pull: PNP/NPN, Dark switching                    |
| <b>Output current I<sub>max</sub></b> | 100 mA  |
| <b>Response time</b>                  | ≤ 500 μs <sup>2)</sup>                                |
| <b>Switching frequency</b>            | 1,000 kHz <sup>3)</sup>                               |
| <b>Connection type</b>                | Cable with M12 male connector, 4-pin, 150 mm          |
| <b>Cable material</b>                 | PVC   |
| <b>Conductor cross section</b>        | 0.13 mm <sup>2</sup>                                  |
| <b>Circuit protection</b>             | A <sup>4)</sup><br>B <sup>5)</sup><br>D <sup>6)</sup> |
| <b>Protection class</b>               | III   |
| <b>Weight</b>                         | 4.54 g  |
| <b>Polarisation filter</b>            | ✓   |
| <b>Housing material</b>               | Plastic, ABS  |
| <b>Optics material</b>                | Plastic, PMMA   |
| <b>Enclosure rating</b>               | IP67  |
| <b>Ambient operating temperature</b>  | -40 °C ... +55 °C                                     |
| <b>Ambient temperature, storage</b>   | -40 °C ... +70 °C                                     |
| <b>UL File No.</b>                    | E189383   |

<sup>1)</sup> Without load.

<sup>2)</sup> Signal transit time with resistive load.

<sup>3)</sup> With light/dark ratio 1:1.

<sup>4)</sup> A = V<sub>S</sub> connections reverse-polarity protected.

<sup>5)</sup> B = inputs and output reverse-polarity protected.

<sup>6)</sup> D = outputs overcurrent and short-circuit protected.

### Classifications

|                     |          |
|---------------------|----------|
| <b>ECLASS 5.0</b>   | 27270902 |
| <b>ECLASS 5.1.4</b> | 27270902 |
| <b>ECLASS 6.0</b>   | 27270902 |
| <b>ECLASS 6.2</b>   | 27270902 |
| <b>ECLASS 7.0</b>   | 27270902 |
| <b>ECLASS 8.0</b>   | 27270902 |
| <b>ECLASS 8.1</b>   | 27270902 |
| <b>ECLASS 9.0</b>   | 27270902 |
| <b>ECLASS 10.0</b>  | 27270902 |
| <b>ECLASS 11.0</b>  | 27270902 |
| <b>ECLASS 12.0</b>  | 27270902 |
| <b>ETIM 5.0</b>     | EC002717 |
| <b>ETIM 6.0</b>     | EC002717 |
| <b>ETIM 7.0</b>     | EC002717 |

|                       |          |
|-----------------------|----------|
| <b>ETIM 8.0</b>       | EC002717 |
| <b>UNSPSC 16.0901</b> | 39121528 |

### Connection type/pinouts

|                               |  |
|-------------------------------|--|
| <b>Connection type</b>        | Cable with M12 male connector, 4-pin, 150 mm |
| <b>Connection type Detail</b> |  |
| Conductor cross section       | 0.13 mm <sup>2</sup>                         |
| Cable material                | PVC  |
| <b>Pinouts</b>                |  |
| BN 1                          | + (L+)                                       |
| WH 2                          | Q <sub>2</sub>                               |
| BU 3                          | - (M)  |
| BK 4                          | Q <sub>1</sub>                               |

### Dimensional drawing (Dimensions in mm (inch))

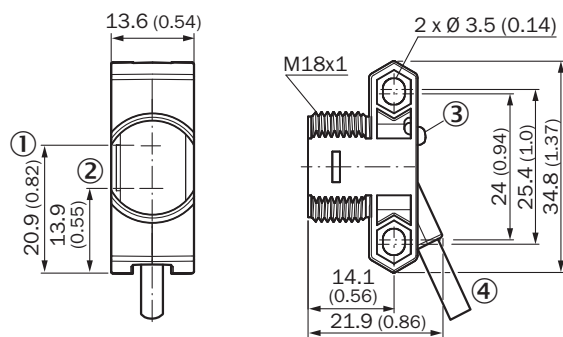

- ① Optical axis, sender
- ② Optical axis, receiver
- ③ LED status indicator
- ④ Connection

### Connection type

Pinouts, see Technical details: **Connection type/pinouts**

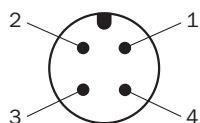

M12 male connector, 4-pin, A-coding

### Characteristic curve

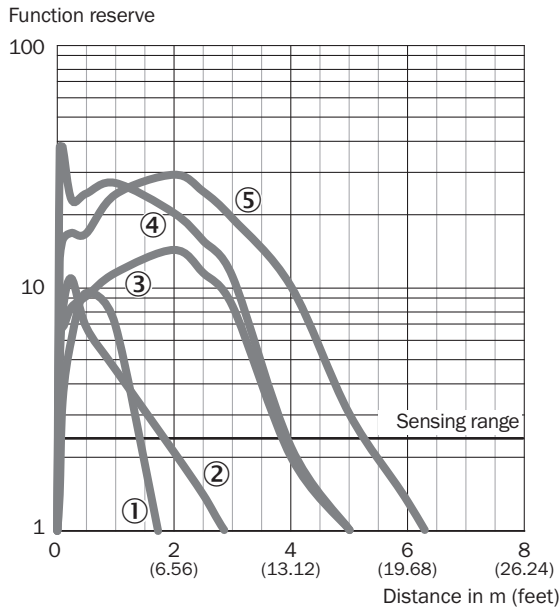

- ① Reflector PL23 FT
- ② Reflector PL20A
- ③ Reflector P250
- ④ Reflector PL40A
- ⑤ Reflector PL80A



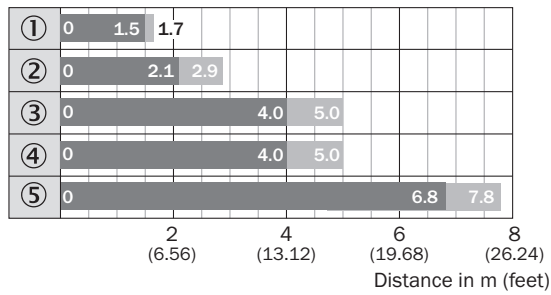

### Sensing range diagram



- Sensing range
- Sensing range typ. max.
- ① Reflector PL23 FT
- ② Reflector PL20A
- ③ Reflector P250
- ④ Reflector PL40A
- ⑤ Reflector PL80A

### Recommended accessories

Other models and accessories → [www.sick.com/Z18\\_Simple\\_Sense](http://www.sick.com/Z18_Simple_Sense)

|   | Brief description   | Type               | Part no. |
|---|---|--------------------|----------|
| Mounting brackets and plates  |   |                    |          |
|  | Universal mounting bracket for reflectors, steel, zinc coated   | BEF-WN-REFX        | 2064574  |
| Plug connectors and cables  |   |                    |          |
|  | <ul style="list-style-type: none"> <li>• <b>Connection type head A:</b> Male connector, M12, 4-pin, straight</li> <li>• <b>Description:</b> Unshielded</li> <li>• <b>Connection systems:</b> Screw-type terminals</li> <li>• <b>Permitted cross-section:</b> ≤ 0.75 mm<sup>2</sup></li> </ul>   | STE-1204-G         | 6009932  |
| Reflectors  |   |                    |          |
|  | Rectangular, screw connection, 51 mm x 61 mm, PMMA/ABS, Screw-on, 2 hole mounting   | P250               | 5304812  |
| Others  |   |                    |          |
|  | <ul style="list-style-type: none"> <li>• <b>Connection type head A:</b> Female connector, M12, 4-pin, straight, A-coded</li> <li>• <b>Connection type head B:</b> Flying leads</li> <li>• <b>Signal type:</b> Sensor/actuator cable</li> <li>• <b>Cable:</b> 5 m, 4-wire, PVC</li> <li>• <b>Description:</b> Sensor/actuator cable, unshielded</li> <li>• <b>Application:</b> Zones with chemicals</li> </ul> | YF2A14-050VB3XLEAX | 2096235  |

## SICK AT A GLANCE

SICK is one of the leading manufacturers of intelligent sensors and sensor solutions for industrial applications. A unique range of products and services creates the perfect basis for controlling processes securely and efficiently, protecting individuals from accidents and preventing damage to the environment.

We have extensive experience in a wide range of industries and understand their processes and requirements. With intelligent sensors, we can deliver exactly what our customers need. In application centers in Europe, Asia and North America, system solutions are tested and optimized in accordance with customer specifications. All this makes us a reliable supplier and development partner.

Comprehensive services complete our offering: SICK LifeTime Services provide support throughout the machine life cycle and ensure safety and productivity.

For us, that is “Sensor Intelligence.”

## WORLDWIDE PRESENCE:

Contacts and other locations –[www.sick.com](http://www.sick.com)