

# Modicon TM7

## Analog I/O Blocks

### Hardware Guide

01/2016



---

The information provided in this documentation contains general descriptions and/or technical characteristics of the performance of the products contained herein. This documentation is not intended as a substitute for and is not to be used for determining suitability or reliability of these products for specific user applications. It is the duty of any such user or integrator to perform the appropriate and complete risk analysis, evaluation and testing of the products with respect to the relevant specific application or use thereof. Neither Schneider Electric nor any of its affiliates or subsidiaries shall be responsible or liable for misuse of the information contained herein. If you have any suggestions for improvements or amendments or have found errors in this publication, please notify us.

No part of this document may be reproduced in any form or by any means, electronic or mechanical, including photocopying, without express written permission of Schneider Electric.

All pertinent state, regional, and local safety regulations must be observed when installing and using this product. For reasons of safety and to help ensure compliance with documented system data, only the manufacturer should perform repairs to components.

When devices are used for applications with technical safety requirements, the relevant instructions must be followed.

Failure to use Schneider Electric software or approved software with our hardware products may result in injury, harm, or improper operating results.

Failure to observe this information can result in injury or equipment damage.

© 2016 Schneider Electric. All rights reserved.

---

# Table of Contents

---



	<b>Safety Information</b> .....	<b>5</b>
	<b>About the Book</b> .....	<b>7</b>
<b>Part I</b>	<b>TM7 System General Overview</b> .....	<b>13</b>
<b>Chapter 1</b>	<b>TM7 System General Rules for Implementing</b> .....	<b>15</b>
	Installation Requirements .....	<b>16</b>
	Wiring Best Practices .....	<b>19</b>
	Environmental Characteristics .....	<b>21</b>
	Installation Guidelines .....	<b>24</b>
	Dimensions .....	<b>31</b>
<b>Chapter 2</b>	<b>I/O Configuration General Information</b> .....	<b>33</b>
	General Description .....	<b>34</b>
	Physical Description .....	<b>36</b>
<b>Part II</b>	<b>TM7 System Analog Input Blocks</b> .....	<b>39</b>
<b>Chapter 3</b>	<b>TM7BAI4•LA Analog Input Blocks</b> .....	<b>41</b>
3.1	TM7BAI4VLA Block 4AI $\pm 10$ Vdc .....	<b>42</b>
	TM7BAI4VLA Presentation .....	<b>43</b>
	TM7BAI4VLA Characteristics .....	<b>46</b>
	TM7BAI4VLA Wiring Diagram .....	<b>49</b>
3.2	TM7BAI4CLA Block 4AI 0-20 mA .....	<b>51</b>
	TM7BAI4CLA Presentation .....	<b>52</b>
	TM7BAI4CLA Characteristics .....	<b>55</b>
	TM7BAI4CLA Wiring Diagram .....	<b>58</b>
<b>Chapter 4</b>	<b>TM7BAI4•LA Analog Temperature Input Blocks</b> .....	<b>61</b>
4.1	TM7BAI4TLA Block 4AI PT100/PT1000 .....	<b>62</b>
	TM7BAI4TLA Presentation .....	<b>63</b>
	TM7BAI4TLA Characteristics .....	<b>66</b>
	TM7BAI4TLA Wiring Diagram .....	<b>69</b>
4.2	TM7BAI4PLA Block 4AI Thermocouple J/K/S .....	<b>72</b>
	TM7BAI4PLA Presentation .....	<b>73</b>
	TM7BAI4PLA Characteristics .....	<b>78</b>
	TM7BAI4PLA Wiring Diagram .....	<b>81</b>

---

<b>Part III</b>	<b>TM7 System Analog Output Blocks</b> .....	<b>83</b>
<b>Chapter 5</b>	<b>TM7BAO4•LA Analog Output Blocks</b> .....	<b>85</b>
5.1	TM7BAO4VLA Block 4AO $\pm 10$ Vdc .....	<b>86</b>
	TM7BAO4VLA Presentation .....	<b>87</b>
	TM7BAO4VLA Characteristics .....	<b>90</b>
	TM7BAO4VLA Wiring Diagram .....	<b>93</b>
5.2	TM7BAO4CLA Block 4AO 0-20 mA .....	<b>95</b>
	TM7BAO4CLA Presentation .....	<b>96</b>
	TM7BAO4CLA Characteristics .....	<b>99</b>
	TM7BAO4CLA Wiring Diagram .....	<b>102</b>
<b>Part IV</b>	<b>TM7 System Analog Mixed Blocks</b> .....	<b>105</b>
<b>Chapter 6</b>	<b>TM7BAM4•LA Analog Mixed Blocks</b> .....	<b>107</b>
6.1	TM7BAM4VLA Block 2AI/2AO $\pm 10$ Vdc .....	<b>108</b>
	TM7BAM4VLA Presentation .....	<b>109</b>
	TM7BAM4VLA Characteristics .....	<b>112</b>
	TM7BAM4VLA Wiring Diagram .....	<b>116</b>
6.2	TM7BAM4CLA Block 2AI/2AO 0-20 mA .....	<b>118</b>
	TM7BAM4CLA Presentation .....	<b>119</b>
	TM7BAM4CLA Characteristics .....	<b>122</b>
	TM7BAM4CLA Wiring Diagram .....	<b>126</b>
<b>Glossary</b>	.....	<b>129</b>
<b>Index</b>	.....	<b>131</b>

---

# Safety Information

---



## Important Information

### NOTICE

Read these instructions carefully, and look at the equipment to become familiar with the device before trying to install, operate, service, or maintain it. The following special messages may appear throughout this documentation or on the equipment to warn of potential hazards or to call attention to information that clarifies or simplifies a procedure.



The addition of this symbol to a “Danger” or “Warning” safety label indicates that an electrical hazard exists which will result in personal injury if the instructions are not followed.



This is the safety alert symbol. It is used to alert you to potential personal injury hazards. Obey all safety messages that follow this symbol to avoid possible injury or death.

## **DANGER**

**DANGER** indicates a hazardous situation which, if not avoided, **will result in** death or serious injury.

## **WARNING**

**WARNING** indicates a hazardous situation which, if not avoided, **could result in** death or serious injury.

## **CAUTION**

**CAUTION** indicates a hazardous situation which, if not avoided, **could result in** minor or moderate injury.

## **NOTICE**

**NOTICE** is used to address practices not related to physical injury.

---

## PLEASE NOTE

Electrical equipment should be installed, operated, serviced, and maintained only by qualified personnel. No responsibility is assumed by Schneider Electric for any consequences arising out of the use of this material.

A qualified person is one who has skills and knowledge related to the construction and operation of electrical equipment and its installation, and has received safety training to recognize and avoid the hazards involved.

---

# About the Book

---



## At a Glance

### Document Scope

This manual describes the hardware implementation of the Modicon TM7 Analog I/O blocks. It provides parts descriptions, specifications, wiring diagrams, installation and setup for Modicon TM7 Analog I/O blocks.

### Validity Note

This document has been updated for the release of SoMachine V4.2.

The technical characteristics of the devices described in this document also appear online. To access this information online:

Step	Action
1	Go to the Schneider Electric home page <a href="http://www.schneider-electric.com">www.schneider-electric.com</a> .
2	In the <b>Search</b> box type the reference of a product or the name of a product range. <ul style="list-style-type: none"><li>● Do not include blank spaces in the reference or product range.</li><li>● To get information on grouping similar modules, use asterisks (*).</li></ul>
3	If you entered a reference, go to the <b>Product Datasheets</b> search results and click on the reference that interests you. If you entered the name of a product range, go to the <b>Product Ranges</b> search results and click on the product range that interests you.
4	If more than one reference appears in the <b>Products</b> search results, click on the reference that interests you.
5	Depending on the size of your screen, you may need to scroll down to see the data sheet.
6	To save or print a data sheet as a .pdf file, click <b>Download XXX product datasheet</b> .

The characteristics that are presented in this manual should be the same as those characteristics that appear online. In line with our policy of constant improvement, we may revise content over time to improve clarity and accuracy. If you see a difference between the manual and online information, use the online information as your reference.

## Related Documents

Title of Documentation	Reference Number
Modicon TM7 Expansion Blocks Configuration Programming Guide	EIO0000000880 (Eng); EIO0000000881 (Fre); EIO0000000882 (Ger); EIO0000000883 (Spa); EIO0000000884 (Ita); EIO0000000885 (Chs)
Modicon M258 Logic Controller Programming Guide	EIO0000000402 (Eng); EIO0000000403 (Fre); EIO0000000404 (Ger); EIO0000000405 (Spa); EIO0000000406 (Ita); EIO0000000407 (Chs)
Modicon LMC058 Motion Controller Programming Guide	EIO0000000408 (Eng); EIO0000000409 (Fre); EIO0000000410 (Ger); EIO0000000411 (Spa); EIO0000000412 (Ita); EIO0000000413 (Chs)
Modicon TM5 / TM7 Flexible System - System Planning and Installation Guide	EIO0000000426 (Eng); EIO0000000427 (Fre); EIO0000000428 (Ger); EIO0000000429 (Spa); EIO0000000430 (Ita); EIO0000000431 (Chs)
Modicon M258 Logic Controller Hardware Guide	EIO0000000432 (Eng); EIO0000000433 (Fre); EIO0000000434 (Ger); EIO0000000435 (Spa); EIO0000000436 (Ita); EIO0000000437 (Chs)
Modicon LMC058 Motion Controller Hardware Guide	EIO0000000438 (Eng); EIO0000000439 (Fre); EIO0000000440 (Ger); EIO0000000441 (Spa); EIO0000000442 (Ita); EIO0000000443 (Chs)
TM7 Analog I/O Blocks Instruction Sheet	S1A3362200

You can download these technical publications and other technical information from our website at <http://download.schneider-electric.com>



---

## Product Related Information

### **DANGER**

#### **HAZARD OF ELECTRIC SHOCK, EXPLOSION OR ARC FLASH**

- Disconnect all power from all equipment including connected devices prior to removing any covers or doors, or installing or removing any accessories, hardware, cables, or wires except under the specific conditions specified in the appropriate hardware guide for this equipment.
- Always use a properly rated voltage sensing device to confirm the power is off where and when indicated.
- Replace and secure all covers, accessories, hardware, cables, and wires and confirm that a proper ground connection exists before applying power to the unit.
- Use only the specified voltage when operating this equipment and any associated products.

**Failure to follow these instructions will result in death or serious injury.**

### **DANGER**

#### **POTENTIAL FOR EXPLOSION**

- Use devices with explosion protection as intended according to these operation instructions and corresponding documents.
- Only permit knowledgeable and qualified personnel to install, maintain and/or operate these devices.
- Conform to valid safety and accident prevention regulations and adhere to standards such as IEC/EN 60079-14.
- Be sure that all other associated equipment, such as cables and connectors, are also suitable for the operating location.
- Ground all devices, using a metal plate, terminal strip or mounting plate securely connected to the housing back plate, to an equalized potential.
- Remove all power from all equipment before installing or removing devices (including other connected devices), accessories, hardware, cables, or wires.
- Devices must remain voltage free until all installation or maintenance work is completed.
- Remove as necessary dust collecting on devices that can cause explosions.
- Be sure that all connectors and sealing plugs on the M8 and M12 connectors are in place and fastened with a torque between 0.2 and 0.4 Nm (1.8 and 3.5 lbf-in) before applying any power.
- Be sure that all connectors are firmly sealed with either properly wired connectors or sealing plugs before applying power during regular operation.

**Failure to follow these instructions will result in death or serious injury.**

## DANGER

### POTENTIAL FOR EXPLOSION

- Only use this equipment in non-hazardous locations or in locations that comply either with the Class I, Division 2, Groups A, B, C and D, or with the ATEX Group II, Zone 2 specifications for hazardous locations, depending on your local and/or national regulations.
- Do not substitute components which would impair compliance to the hazardous location specifications of this equipment.
- Do not connect or disconnect equipment unless power has been removed or the location is known to be non-hazardous.

**Failure to follow these instructions will result in death or serious injury.**

**NOTE:** Additional equipment used in conjunction with the equipment described herein must also be suitable for the operating location.

## WARNING

### LOSS OF CONTROL

- The designer of any control scheme must consider the potential failure modes of control paths and, for certain critical control functions, provide a means to achieve a safe state during and after a path failure. Examples of critical control functions are emergency stop and overtravel stop, power outage and restart.
- Separate or redundant control paths must be provided for critical control functions.
- System control paths may include communication links. Consideration must be given to the implications of unanticipated transmission delays or failures of the link.
- Observe all accident prevention regulations and local safety guidelines.<sup>1</sup>
- Each implementation of this equipment must be individually and thoroughly tested for proper operation before being placed into service.

**Failure to follow these instructions can result in death, serious injury, or equipment damage.**

<sup>1</sup> For additional information, refer to NEMA ICS 1.1 (latest edition), "Safety Guidelines for the Application, Installation, and Maintenance of Solid State Control" and to NEMA ICS 7.1 (latest edition), "Safety Standards for Construction and Guide for Selection, Installation and Operation of Adjustable-Speed Drive Systems" or their equivalent governing your particular location.

## WARNING

### UNINTENDED EQUIPMENT OPERATION

- Only use software approved by Schneider Electric for use with this equipment.
- Update your application program every time you change the physical hardware configuration.

**Failure to follow these instructions can result in death, serious injury, or equipment damage.**

### Terminology Derived from Standards

The technical terms, terminology, symbols and the corresponding descriptions in this manual, or that appear in or on the products themselves, are generally derived from the terms or definitions of international standards.

In the area of functional safety systems, drives and general automation, this may include, but is not limited to, terms such as *safety*, *safety function*, *safe state*, *fault*, *fault reset*, *malfunction*, *failure*, *error*, *error message*, *dangerous*, etc.

Among others, these standards include:

Standard	Description
EN 61131-2:2007	Programmable controllers, part 2: Equipment requirements and tests.
ISO 13849-1:2008	Safety of machinery: Safety related parts of control systems. General principles for design.
EN 61496-1:2013	Safety of machinery: Electro-sensitive protective equipment. Part 1: General requirements and tests.
ISO 12100:2010	Safety of machinery - General principles for design - Risk assessment and risk reduction
EN 60204-1:2006	Safety of machinery - Electrical equipment of machines - Part 1: General requirements
EN 1088:2008 ISO 14119:2013	Safety of machinery - Interlocking devices associated with guards - Principles for design and selection
ISO 13850:2006	Safety of machinery - Emergency stop - Principles for design
EN/IEC 62061:2005	Safety of machinery - Functional safety of safety-related electrical, electronic, and electronic programmable control systems
IEC 61508-1:2010	Functional safety of electrical/electronic/programmable electronic safety-related systems: General requirements.
IEC 61508-2:2010	Functional safety of electrical/electronic/programmable electronic safety-related systems: Requirements for electrical/electronic/programmable electronic safety-related systems.
IEC 61508-3:2010	Functional safety of electrical/electronic/programmable electronic safety-related systems: Software requirements.

Standard	Description
IEC 61784-3:2008	Digital data communication for measurement and control: Functional safety field buses.
2006/42/EC	Machinery Directive
2004/108/EC	Electromagnetic Compatibility Directive
2006/95/EC	Low Voltage Directive

In addition, terms used in the present document may tangentially be used as they are derived from other standards such as:

Standard	Description
IEC 60034 series	Rotating electrical machines
IEC 61800 series	Adjustable speed electrical power drive systems
IEC 61158 series	Digital data communications for measurement and control – Fieldbus for use in industrial control systems

Finally, the term *zone of operation* may be used in conjunction with the description of specific hazards, and is defined as it is for a *hazard zone* or *danger zone* in the *EC Machinery Directive (EC/2006/42)* and *ISO 12100:2010*.

**NOTE:** The aforementioned standards may or may not apply to the specific products cited in the present documentation. For more information concerning the individual standards applicable to the products described herein, see the characteristics tables for those product references.

---

# Part I

## TM7 System General Overview

---

### What Is in This Part?

This part contains the following chapters:

Chapter	Chapter Name	Page
1	TM7 System General Rules for Implementing	15
2	I/O Configuration General Information	33



---

# Chapter 1

## TM7 System General Rules for Implementing

---

### What Is in This Chapter?

This chapter contains the following topics:

Topic	Page
Installation Requirements	16
Wiring Best Practices	19
Environmental Characteristics	21
Installation Guidelines	24
Dimensions	31

## Installation Requirements

### Before Starting

Read and understand this chapter before beginning the installation of your TM7 System.

## DANGER

### POTENTIAL FOR EXPLOSION

- Use devices with explosion protection as intended according to these operation instructions and corresponding documents.
- Only permit knowledgeable and qualified personnel to install, maintain and/or operate these devices.
- Conform to valid safety and accident prevention regulations and adhere to standards such as IEC/EN 60079-14.
- Be sure that all other associated equipment, such as cables and connectors, are also suitable for the operating location.
- Ground all devices, using a metal plate, terminal strip or mounting plate securely connected to the housing back plate, to an equalized potential.
- Remove all power from all equipment before installing or removing devices (including other connected devices), accessories, hardware, cables, or wires.
- Devices must remain voltage free until all installation or maintenance work is completed.
- Remove as necessary dust collecting on devices that can cause explosions.
- Be sure that all connectors and sealing plugs on the M8 and M12 connectors are in place and fastened with a torque between 0.2 and 0.4 Nm (1.8 and 3.5 lbf-in) before applying any power.
- Be sure that all connectors are firmly sealed with either properly wired connectors or sealing plugs before applying power during regular operation.

**Failure to follow these instructions will result in death or serious injury.**

## NOTICE

### ELECTROSTATIC DISCHARGE

- Never touch the pin connectors of the block.
- Always keep the cables or sealing plugs in place during normal operation.

**Failure to follow these instructions can result in equipment damage.**



## Programming Considerations

### WARNING

#### UNINTENDED EQUIPMENT OPERATION

- Only use software approved by Schneider Electric for use with this equipment.
- Update your application program every time you change the physical hardware configuration.

**Failure to follow these instructions can result in death, serious injury, or equipment damage.**

## Operating Environment

### DANGER

#### POTENTIAL FOR EXPLOSION

- Only use this equipment in non-hazardous locations or in locations that comply either with the Class I, Division 2, Groups A, B, C and D, or with the ATEX Group II, Zone 2 specifications for hazardous locations, depending on your local and/or national regulations.
- Do not substitute components which would impair compliance to the hazardous location specifications of this equipment.
- Do not connect or disconnect equipment unless power has been removed or the location is known to be non-hazardous.

**Failure to follow these instructions will result in death or serious injury.**

**NOTE:** Additional equipment used in conjunction with the equipment described herein must also be suitable for the operating location.

Requirements for use in ATEX Group II, Zone 2:

- Install and use the equipment strictly in accordance to the installation and operating instructions found here and in other related documentation.
- Respect and follow all valid safety and accident prevention regulations, as well as adhering to standards such as IEC/EN 60079-14 or those that govern the eventual locality of your application.
- All equipment must be grounded to an equipotential ground plane dimensioned to the power system of your application.
- Equipment must remain unpowered until installation work is completed, including all cable connections with the proper torque having been applied to all connector unions.
- Before applying power, be sure that all connectors that are not being used (open connectors with no cable attached) are capped with suitable sealing plugs.
- During service or maintenance, the equipment must be shut down and protected from being accidentally restarted.
- Do not connect or disconnect cables or sealing plugs under power unless the equipment is in a known non-hazardous location.

** WARNING**

**UNINTENDED EQUIPMENT OPERATION**

Install and operate this equipment according to the conditions described in the Environmental Characteristics.

**Failure to follow these instructions can result in death, serious injury, or equipment damage.**

**Installation Considerations**

** WARNING**

**UNINTENDED EQUIPMENT OPERATION**

- Use appropriate safety interlocks where personnel and/or equipment hazards exist.
- Use the sensor and actuator power supplies only for supplying power to the sensors or actuators connected to the module.
- Power line and output circuits must be wired and fused in compliance with local and national regulatory requirements for the rated current and voltage of the particular equipment.
- Do not use this equipment in safety-critical machine functions.
- Do not disassemble, repair, or modify this equipment.
- Do not connect any wiring to unused connections, or to connections designated as Not Connected (N.C.).

**Failure to follow these instructions can result in death, serious injury, or equipment damage.**

**NOTE:** Use UL-recognized and CSA approved JDYX2 or JDYX8 fuse types.

## Wiring Best Practices

### Introduction

There are several rules that must be followed when wiring a TM7 System. Refer to TM7 Cables (*see Modicon TM5 / TM7 Flexible System, System Planning and Installation Guide*) for additional details.

### Wiring Rules

 **DANGER**

**HAZARD OF ELECTRIC SHOCK, EXPLOSION OR ARC FLASH**

- Disconnect all power from all equipment including connected devices prior to removing any covers or doors, or installing or removing any accessories, hardware, cables, or wires except under the specific conditions specified in the appropriate hardware guide for this equipment.
- Always use a properly rated voltage sensing device to confirm the power is off where and when indicated.
- Replace and secure all covers, accessories, hardware, cables, and wires and confirm that a proper ground connection exists before applying power to the unit.
- Use only the specified voltage when operating this equipment and any associated products.

**Failure to follow these instructions will result in death or serious injury.**

The following rules must be applied when wiring the TM7 System:

- I/O and communication wiring must be kept separate from the power wiring. Route these 2 types of wiring in separate cable ducting.
- Verify that the operating conditions and environment are within the specification values.
- Use proper wire sizes to meet voltage and current requirements.
- Use copper conductors only.
- Use only the TM7 expansion bus cables (*see Modicon TM5 / TM7 Flexible System, System Planning and Installation Guide*).

## TM7 Blocks Grounding

The TM7 System blocks, when using Schneider Electric IP67 pre-fabricated cables, incorporate a grounding system intrinsic to the mounting and connecting hardware. The TM7 System blocks must always be mounted on a conductive backplane. The backplane or object used for mounting the blocks (metal machine frame, mounting rail or mounting plate) must be grounded (PE) according to your local, regional and national requirements and regulations. Refer to grounding of your system blocks (see *Modicon TM5 / TM7 Flexible System, System Planning and Installation Guide*), for more important information.

**NOTE:** If you do not use Schneider Electric IP67 pre-fabricated cables, you must use shielded cables and conductive connectors (metal threads on the connector), and be sure to connect the cable shield to the metal sleeve of the connector.

### **⚠ WARNING**

#### **IMPROPER GROUNDING CONTINUITY**

- Use only cables with insulated, shielded jackets.
- Use only IP67 connectors with metal threads.
- Connect the cable shield to the metal threads of the connectors.
- Always comply with local, regional and/or national wiring requirements.

**Failure to follow these instructions can result in death, serious injury, or equipment damage.**

The following figure shows the grounding of the TM7 System:

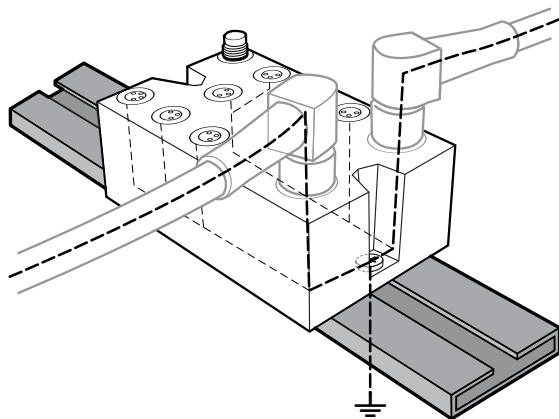

## Environmental Characteristics

### Introduction



The following information describes the system-wide environmental requirements and characteristics for the TM7 System.

The general environmental characteristics are common to all components of the TM7 System.

### Environmental Characteristics

This equipment meets cURus, GOST-R and c-Tick certifications and CE requirements as indicated in the table below. This equipment is intended for use in a Pollution Degree 2 industrial environment.

The table below provides the general environmental characteristics:

Characteristic	Specification	
This product is compliant with Europe RoHS recommendations and China RoHS regulations.		
		
	II 3G	Device group II, Category 3, Zone 2 suitable for explosive gas
	Ex	Protection according to European standards
	nA	Ignition protection "n"
	IIA	Gas group
	T5	Temperature class
	Gc	Equipment protection level (EPL)
	84 °C (183 °F)	Maximum surface temperature
	IP67	Protection index according to EN/IEC 60529
	Ta = 0...60 °C (32...140 °F) <sup>1</sup>	Ambient temperature range
	TÜV 10 ATEX 7939 X	Certificate number
Standard	IEC61131-2 ed. 3 2007	
Agencies	UL 508 CSA 22.2 No. 142-M1987 CSA 22.2 No. 213-M1987	
Ambient operating temperature	-10...60 °C (14...140 °F) <sup>1</sup>	
<sup>1</sup> For compliance to ATEX and Class I, Div 2 environment ratings, do not operate this device in locations with ambient temperatures less than 0 °C (32 °F). <sup>2</sup> Reduction of ambient temperature by 0.5 °C (32.5 °F) for every additional 100 m (328 ft.) of altitude beyond 2000 m (6560 ft.).		

Characteristic	Specification	
Storage temperature		-25...85 °C (-13...185 °F)
Relative humidity		5...95% (non-condensing)
Pollution degree	IEC60664	2 (non-conductive material)
Protection degree	EN/IEC60529	IP67
Operating altitude		0...2000 m (0...6560 ft.)
		2000...3000 m (6560...9842 ft.) <sup>2</sup>
Vibration resistance	IEC60721-3-5 Class 5M3	7.5 mm (0.295 in.) fixed amplitude from 2...8 Hz 20 m/s <sup>2</sup> (2 g <sub>n</sub> ) fixed acceleration from 8...200 Hz 40 m/s <sup>2</sup> (4 g <sub>n</sub> ) fixed acceleration from 200...500 Hz
Mechanical shock resistance	IEC60721-3-5 Class 5M3	300 m/s <sup>2</sup> (30 g <sub>n</sub> ) for a duration of 11 ms, half sine wave, shock type 1
Connection type		M8 or M12 depending on the I/O block
<sup>1</sup> For compliance to ATEX and Class I, Div 2 environment ratings, do not operate this device in locations with ambient temperatures less than 0 °C (32 °F). <sup>2</sup> Reduction of ambient temperature by 0.5 °C (32.5 °F) for every additional 100 m (328 ft.) of altitude beyond 2000 m (6560 ft.).		

### Electromagnetic Susceptibility

The table below provides the TM7 System electromagnetic susceptibility specifications:

Characteristic	Specification	Range
Electrostatic discharge	EN/IEC 61000-4-2	± 8 kV, criteria B (air discharge) ± 6 kV, criteria B (contact discharge)
Electromagnetic fields	EN/IEC 61000-4-3	10 V/m, 80% amplitude modulation at 1 kHz (80 MHz...2 GHz) 1 V/m (2...2.7 GHz)
Fast transients burst	EN/IEC 61000-4-4	Power lines: 2 kV, criteria B I/O: 1 kV, criteria B Shielded cable: 1 kV, criteria B Repetition rate: 5 and 100 kHz
Surge immunity 24 Vdc circuit	EN/IEC 61000-4-5	Power lines: 1 kV (12 Ω), criteria B in common mode 0.5 kV (2 Ω), criteria B in differential mode
		Unshielded lines: 0.5 kV (42 Ω), criteria B in common mode 1 kV (42 Ω), criteria B in differential mode
		Shielded lines: 1 kV (12 Ω), criteria B in common mode 0.5 kV (2 Ω), criteria B in differential mode

Characteristic	Specification	Range
Induced electromagnetic field	EN/IEC 61000-4-6	Network, I/O signal connections > 10 m (32.8 ft.), functional ground connection: 10 V <sub>eff</sub> , criteria A, 80% amplitude modulation at 1 kHz (150...80 MHz)
Conducted emission	EN 55011 (IEC/CISPR11)	150...500 kHz quasi peak 79 dB $\mu$ V
		500 kHz...30 MHz quasi peak 73 dB $\mu$ V
Radiated emission	EN 55011 (IEC/CISPR11)	30...230 MHz, 10 m (32.8 ft)@40 dB ( $\mu$ V/m)
		230 MHz...1 GHz, 10 m (32.8 ft)@47 dB ( $\mu$ V/m)

### Conformity and Test Certification

These devices were developed and tested according to valid European guidelines and standards. Modules labeled ATEX meet the following EU guidelines including all changes:

Characteristic	Specification
Electromagnetic compatibility (EMC)	2004/108/EC
Low voltage (LV)	2006/95/EC
Equipment explosive atmospheres (ATEX)	94/9/EC
Standards met	EN 61131-2, EN 61000-6-2, EN 61000-6-4, EN 60204-1, EN 50178, EN 60079-15

## Installation Guidelines

### Introduction

The TM7 System can be mounted using:

- An aluminium frame with two wedge nuts and M4 screws
- A DIN rail with TM7ACMP mounting plate
- Directly on the machine.

**NOTE:** Mounting on a DIN rail using the TM7ACMP mounting plate is only possible with the size 1 (smallest) block dimension (see *Modicon TM5 / TM7 Flexible System, System Planning and Installation Guide*).

**NOTE:** The TM7 System components must always be mounted to a conductive backplane.

### TM7 Block on an Aluminium Frame

Blocks can be mounted on an aluminium frame with two wedge nuts and M4 screws:

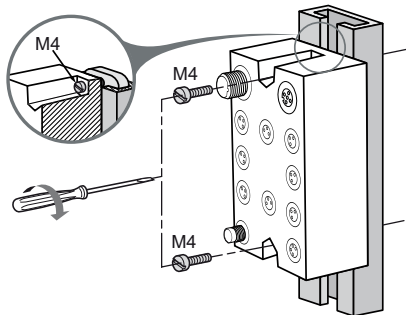

**NOTE:** Maximum torque to fasten the M4 screws is 0.6 N.m (5.3 lbf-in).

## **NOTICE**

### **INOPERABLE EQUIPMENT**

- Ensure that the block is securely affixed to its mounting surface.
- Do not tighten screws beyond the specified maximum torque.

**Failure to follow these instructions can result in equipment damage.**



### TM7 Block on a DIN Rail

You can mount the size 1 blocks on a DIN rail with the TM7ACMP (see *Modicon TM5 / TM7 Flexible System, System Planning and Installation Guide*) mounting plate. For EMC (Electromagnetic Compatibility) compliance, a metal DIN rail must be attached to a flat metal mounting surface or mounted on an EIA (Electronic Industries Alliance) rack or in a NEMA (National Electrical Manufacturers Association) enclosure. In all cases, the mounting surface must be properly grounded (see *Modicon TM5 / TM7 Flexible System, System Planning and Installation Guide*).

You can order a suitable DIN rail from Schneider Electric:

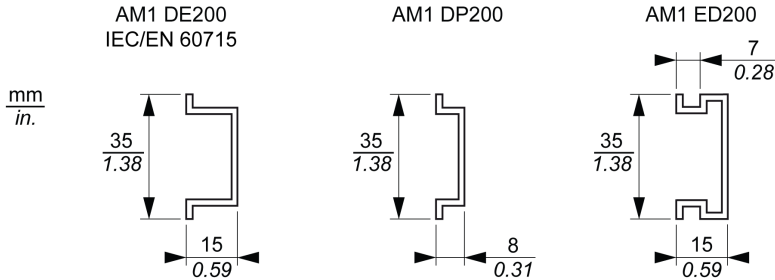

**NOTE:** Only size 1 (smallest) blocks can be installed on DIN rail with the mounting plate.

## **NOTICE**

### **INOPERABLE EQUIPMENT**

- Ensure that the block is securely affixed to its mounting surface.
- Do not tighten screws beyond the specified maximum torque.

**Failure to follow these instructions can result in equipment damage.**

The following procedure gives step by step instructions to assemble and install a block on a DIN rail:

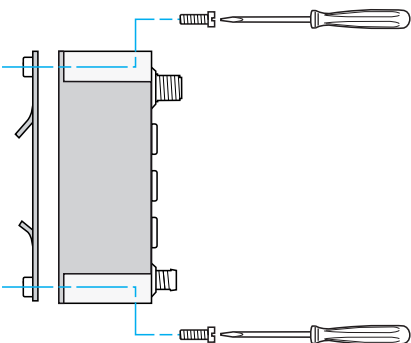
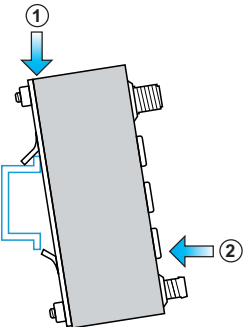
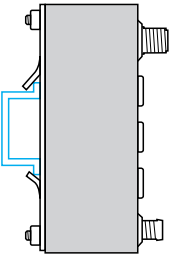
Step	Action	
1	<p>Screw the block to the mounting plate. The required screws are supplied with the mounting plate.</p> <p><b>NOTE:</b> Maximum torque to fasten the required screws is 0.6 Nm (5.3 lbf-in).</p>	
2	<p>Place the upper protruding catches of the mounting plate on the top edge of the DIN rail (1). Rotate the block to the DIN rail until it clicks (2).</p>	
3	<p>The block is correctly installed to the DIN rail</p>	

For more information on mounting the DIN rail refer to the TM5 section DIN Rail Installation (see *Modicon TM5 / TM7 Flexible System, System Planning and Installation Guide*).

**TM7 Block Directly on the Machine**

The TM7 block can be mounted to any bare-metal surface of the machine, provided that the surface is properly grounded (see *Modicon TM5 / TM7 Flexible System, System Planning and Installation Guide*). To mount the block directly on the machine, the following figure gives the drilling template of the blocks:

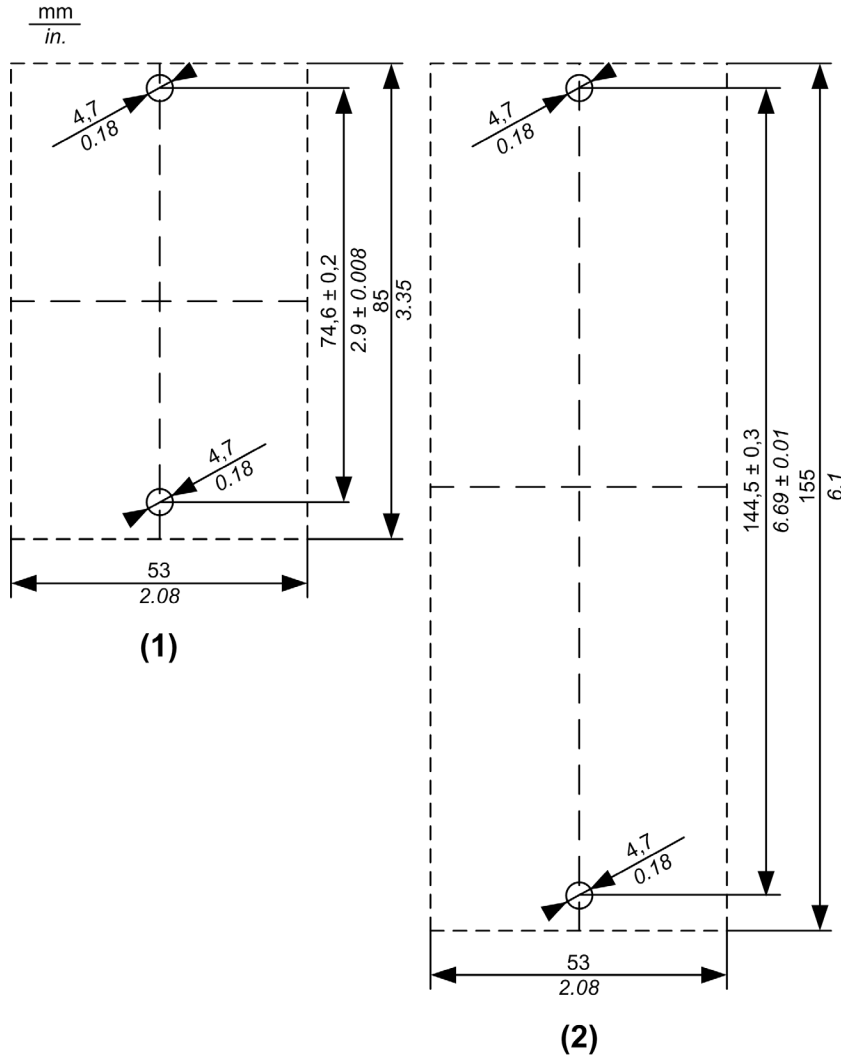

- (1) Size 1
- (2) Size 2

The thickness of the base plate should be taken into consideration when defining the screw length.

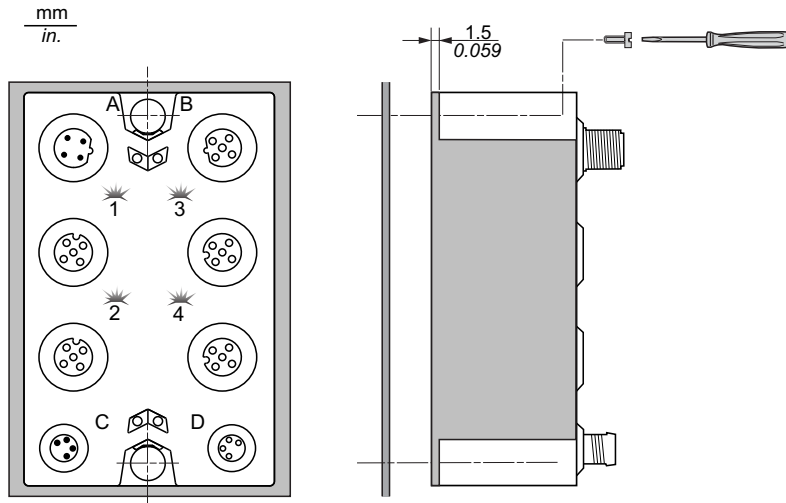

**NOTE:** Maximum torque to fasten the required M4 screws is 0.6 Nm (5.3 lbf-in).

## ***NOTICE***

### **INOPERABLE EQUIPMENT**

- Ensure that the block is securely affixed to its mounting surface.
- Do not tighten screws beyond the specified maximum torque.

**Failure to follow these instructions can result in equipment damage.**

## TM7 Cable Installation

The plug connector of the TM7 cables (see *Modicon TM5 / TM7 Flexible System, System Planning and Installation Guide*) is mounted by hand and then tightened to a defined force with the aid of the torque wrench (see *Modicon TM5 / TM7 Flexible System, System Planning and Installation Guide*):

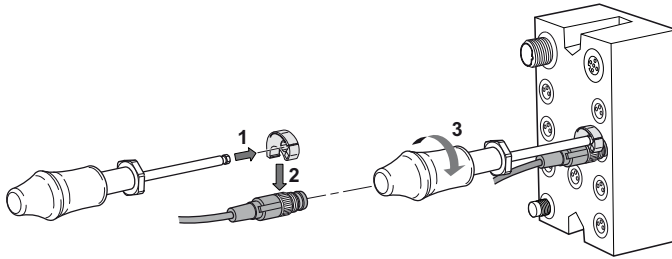

Connector Size	Preset Torque
M8	0.2 Nm (1.8 lbf-in)
M12	0.4 Nm (3.5 lbf-in)

## **⚠ WARNING**

### **IP67 NON-CONFORMANCE**

- Properly fit all connectors with cables or sealing plugs and tighten for IP67 conformance according to the torque values as specified in this document.
- Do not connect or disconnect cables or sealing plugs in the presence of water or moisture.

**Failure to follow these instructions can result in death, serious injury, or equipment damage.**

### Sealing Plug Installation

Open connectors with no cable attached are capped with suitable sealing plugs (see *Modicon TM5 / TM7 Flexible System, System Planning and Installation Guide*):

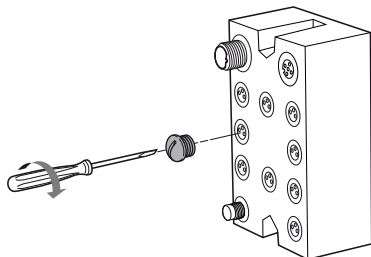

Connector Size	Preset Torque
M8	0.2 Nm (1.8 lbf-in)
M12	0.4 Nm (3.5 lbf-in)

## ⚠ WARNING

### IP67 NON-CONFORMANCE

- Properly fit all connectors with cables or sealing plugs and tighten for IP67 conformance according to the torque values as specified in this document.
- Do not connect or disconnect cables or sealing plugs in the presence of water or moisture.

**Failure to follow these instructions can result in death, serious injury, or equipment damage.**

### TM7 Block Labeling

The support for block label and its label are inserted in the appropriate opening in the top (the figure below) or in the bottom of the block:

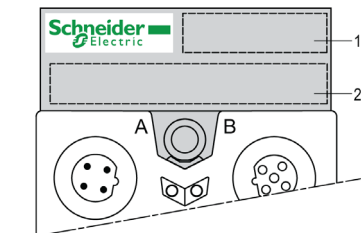

- 1 Reference of the block
- 2 Area for customer

## Dimensions

### Dimensions

The following figures show the dimensions of the TM7 blocks:

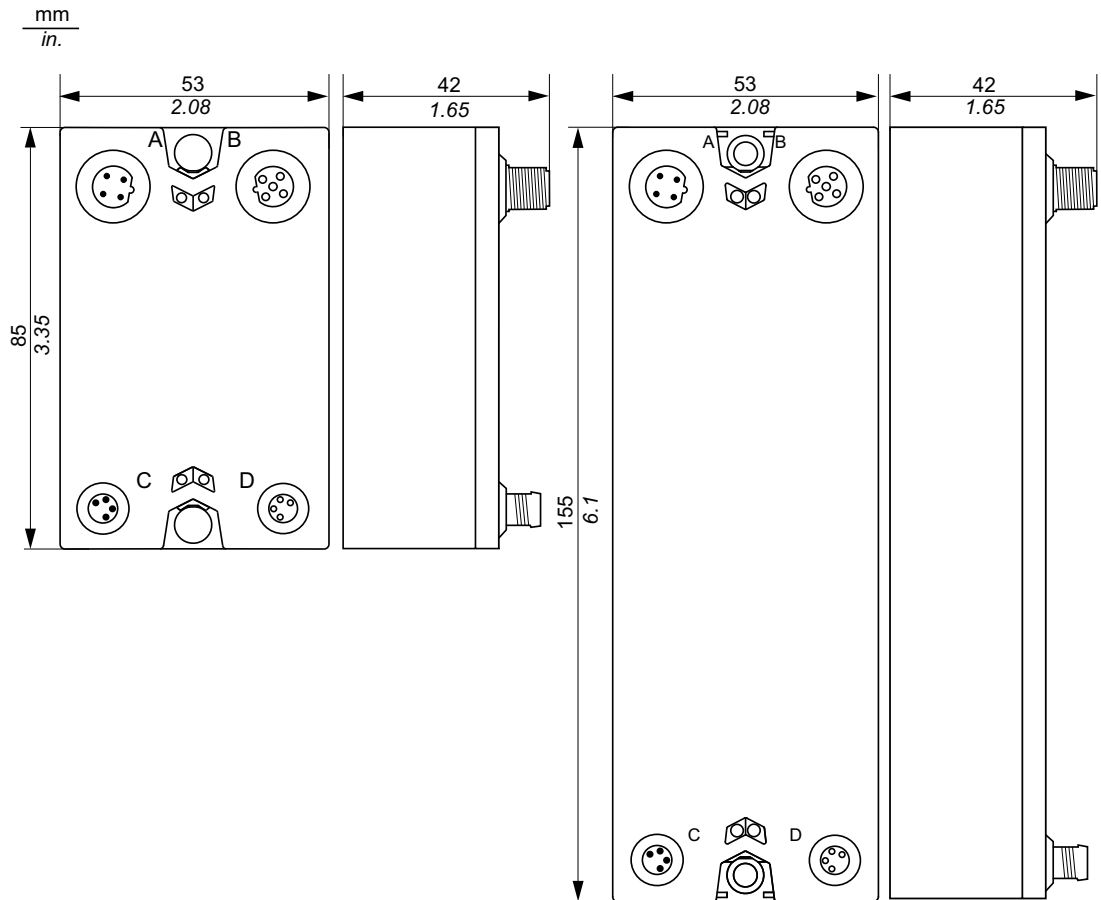





---

# Chapter 2

## I/O Configuration General Information

---

### Introduction

This chapter provides the general considerations to configure I/O expansion blocks.

### What Is in This Chapter?

This chapter contains the following topics:

Topic	Page
General Description	34
Physical Description	36

## General Description

### Introduction

The range of TM7 Analog I/O blocks includes:

- Analog input blocks
- Analog temperature input blocks
- Analog output blocks
- Analog mixed input/output blocks

The TM7 Analog I/O blocks need to be associated with IP67 power cables, TM7 bus cables and I/O cables.

### Analog Input Block Features

Analog input blocks convert measured values (voltages, currents) into numerical values, which can be processed by the controller.

Reference	Number of Channels	Digital Converter Resolution	Voltage/Current	Sensor Connectors
TM7BAI4VLA (see page 43)	4	11 bit + sign	-10...+10 Vdc	M12
TM7BAI4CLA (see page 52)	4	12 bit	0...20 mA	M12

### Analog Temperature Block Features

Temperature measurement values are converted into number values which can be processed by the controller using temperature blocks. For temperature measurements, the temperature block returns the measured value using  $0.1^{\circ}\text{C}$  ( $0.18^{\circ}\text{F}$ ) steps.

The step value  $0.1^{\circ}\text{C}$  ( $0.18^{\circ}\text{F}$ ) is supported as standard by all temperature blocks.

Reference	Number of Channels	Digital Converter Resolution	Sensor Type	Sensor Connectors
TM7BAI4TLA (see page 63)	4	16 bit	PT100 / 1000 KTY10 / KTY84 (Silicon sensor)	M12
TM7BAI4PLA (see page 73)	4	16 bit	Thermocouple J, K, S	M12

### Analog Output Block Features

Analog output blocks convert controller internal numerical values into voltages or currents.

Reference	Number of Channels	Digital Converter Resolution	Voltage/Current	Actuator Connectors
TM7BAO4VLA <i>(see page 87)</i>	4	11 bit + sign	-10...+10 Vdc	M12
TM7BAO4CLA <i>(see page 96)</i>	4	12 bit	0...20 mA	M12

### Analog Mixed Input/Output Block Features

Analog inputs convert measured values (voltages, currents) into numerical values, which can be processed by the controller. Analog outputs convert controller internal numerical values into voltages or currents.

Reference	Number of Channels	Digital Converter Resolution	Voltage/Current	Sensor/Actuator Connectors
TM7BAM4VLA <i>(see page 109)</i>	2 inputs	11 bit + sign	-10...+10 Vdc	M12
	2 outputs	11 bit + sign	-10...+10 Vdc	M12
TM7BAM4CLA <i>(see page 119)</i>	2 inputs	12 bit	0...20 mA	M12
	2 outputs	12 bit	0...20 mA	M12

## Physical Description

### Introduction

The TM7 System consists of IP67 I/O blocks along with field bus, expansion, sensor/actuator and power cables.

A TM7 I/O block can be a:

- digital I/O block, for details, refer to the *Modicon TM7 Digital I/O Blocks Hardware Guide*
- analog I/O block
- Power Distribution Block (PDB), for details, refer to the chapter *TM7SPS1A Power Distribution Block (PDB)* in the *Modicon TM5 / TM7 Flexible System - System Planning and Installation Guide*

### General View of a TM7 I/O Block and Cables

The following figure shows a TM7 I/O block and associated cables:

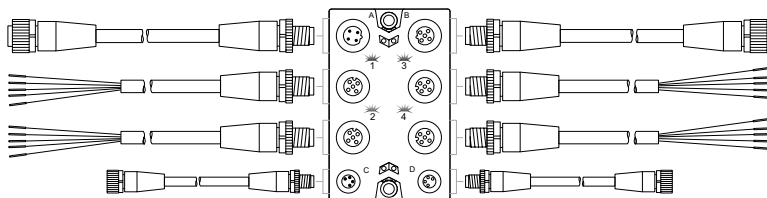

Item	TM7 Cable Type	TM7 Block Connector
A	Expansion bus drop cable	TM7 bus IN
B	Expansion bus drop cable	TM7 bus OUT
1...4	Sensor or actuator cable	I/O connectors
C	Power drop cable	24 Vdc power IN connector
D	Power drop cable	24 Vdc power OUT connector

## **⚠ WARNING**

### **IP67 NON-CONFORMANCE**

- Properly fit all connectors with cables or sealing plugs and tighten for IP67 conformance according to the torque values as specified in this document.
- Do not connect or disconnect cables or sealing plugs in the presence of water or moisture.

**Failure to follow these instructions can result in death, serious injury, or equipment damage.**

## **NOTICE**

### **ELECTROSTATIC DISCHARGE**

- Never touch the pin connectors of the block.
- Always keep the cables or sealing plugs in place during normal operation.

**Failure to follow these instructions can result in equipment damage.**

### **TM7 Cables References**

Refer to TM7 Cables (see *Modicon TM5 / TM7 Flexible System, System Planning and Installation Guide*), for more information on the type and length of cables, along with their references.

### **TM7 I/O Blocks Pin and Connector Assignments**

The following figure shows the connector assignments of a TM7 I/O block:

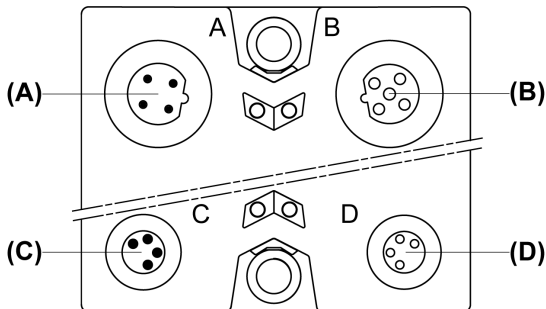

- (A) TM7 bus IN connector M12
- (B) TM7 bus OUT connector M12
- (C) 24 Vdc power IN connector M8
- (D) 24 Vdc power OUT connector M8

The following figure shows the pin assignments of the TM7 bus IN (A) and OUT (B) connectors:

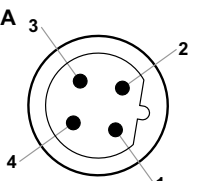
Connection	Pin	Designation
	1	TM7 V+
	2	TM7 Bus Data
	3	TM7 0 Vdc
	4	TM7 Bus $\overline{\text{Data}}$
	5	N.C.

The following figure shows the pin assignments of the 24 Vdc power IN (C) and OUT (D) connectors:

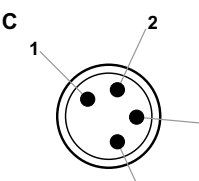
Connection	Pin	Designation
	1	24 Vdc I/O power segment
	2	24 Vdc I/O power segment
	3	0 Vdc
	4	0 Vdc

**NOTE:**

- The status of the LEDs are provided in the *Presentation* section of each I/O block.
- The pin assignments of the I/O connectors are provided in the *Wiring Diagram* section of each I/O block.

---

# Part II

## TM7 System Analog Input Blocks

---

### What Is in This Part?

This part contains the following chapters:

Chapter	Chapter Name	Page
3	TM7BAI4•LA Analog Input Blocks	41
4	TM7BAI4•LA Analog Temperature Input Blocks	61





---

# Chapter 3

## TM7BAI4•LA Analog Input Blocks

---

### What Is in This Chapter?

This chapter contains the following sections:

Section	Topic	Page
3.1	TM7BAI4VLA Block 4AI $\pm 10$ Vdc	42
3.2	TM7BAI4CLA Block 4AI 0-20 mA	51

## Section 3.1

### TM7BAI4VLA Block 4AI $\pm 10$ Vdc

---

#### What Is in This Section?

This section contains the following topics:

Topic	Page
TM7BAI4VLA Presentation	43
TM7BAI4VLA Characteristics	46
TM7BAI4VLA Wiring Diagram	49

## TM7BAI4VLA Presentation

### Main Characteristics

The table below provides the main characteristics of the TM7BAI4VLA block:

Main characteristics	
Number of input channels	4
Signal type	Voltage
Input range	-10...+10 Vdc
Resolution	11 bits + sign
Sensor connection type	M12, A coded, female connector type <i>(see page 49)</i>

### Description

The following figure shows the TM7BAI4VLA block:

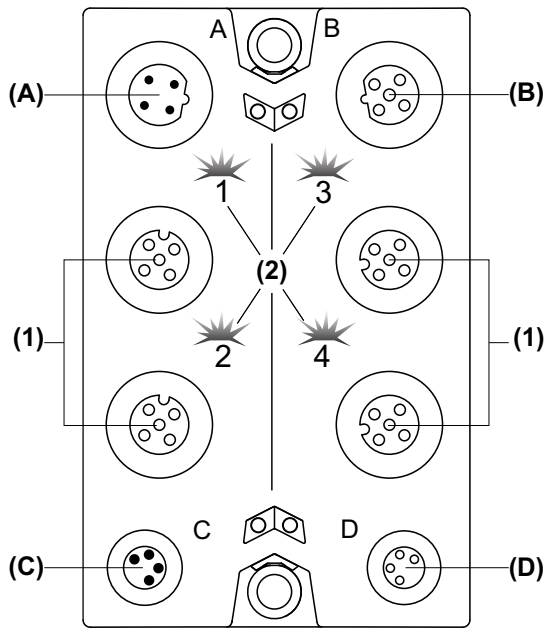

- (A) TM7 bus IN connector
- (B) TM7 bus OUT connector
- (C) 24 Vdc power IN connector
- (D) 24 Vdc power OUT connector
- (1) Input connectors
- (2) Status LEDs

### Connector and Channel Assignments

The table below provides the connector and channel assignments of the TM7BAI4VLA block:

Input connectors	Input status LEDs	Channel type	Channels
1	1	Input	I0
2	2	Input	I1
3	3	Input	I2
4	4	Input	I3

### Status LEDs

The following figure shows the status LEDs of the TM7BAI4VLA block:

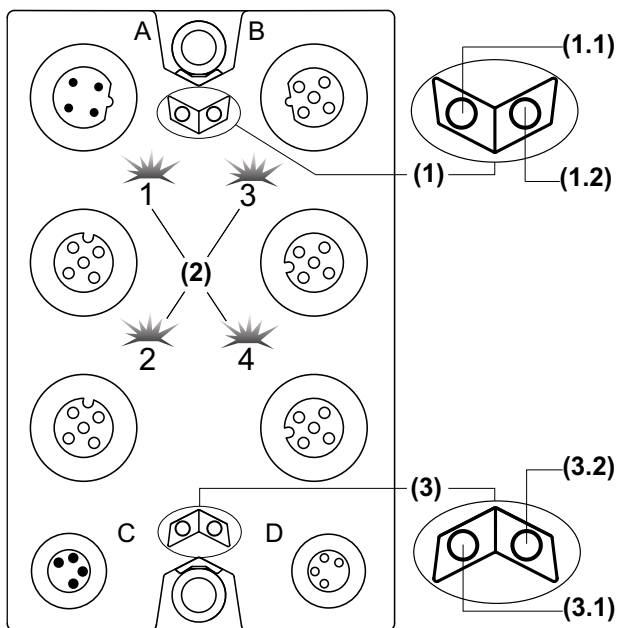

- (1) TM7 bus status LEDs, set of two LEDs: 1.1 (green) and 1.2 (red)
- (2) Input status LEDs, composed of four LEDs: 1, 2, 3 and 4 (green)
- (3) Input block status LEDs, set of two LEDs: 3.1 (green) and 3.2 (red)

The table below provides the TM7 bus status LEDs of the TM7BAI4VLA block:

TM7 bus status LEDs		Description
LED 1.1	LED 1.2	
OFF	OFF	No power supply on TM7 bus
ON	ON	TM7 bus in preoperational state: <ul style="list-style-type: none"> <li>● power supply on TM7 bus and</li> <li>● block not initialized</li> </ul>
ON	OFF	TM7 bus in operational state
OFF	ON	TM7 bus error detected

The table below provides the input status LEDs of the TM7BAI4VLA block:

Channel LEDs	State	Description
1 - 4	OFF	Open connection or sensor is disconnected
	Flashing	Overflow or underflow of the input signal
	ON	The analog/digital converter is running, a value is available

The table below provides the input block status LEDs of the TM7BAI4VLA block:

Block Status LEDs	State	Description
3.1	OFF	No power supply
	Single Flash	Reset state
	Flashing	Preoperational state
	ON	Operational state
3.2	OFF	OK or no power supply
	Single Flash	Detected error for an input channel
	Double Flash	Power supply not in the valid range
	ON	Detected error or reset state

## TM7BAI4VLA Characteristics

### General Characteristics

#### **DANGER**

##### **POTENTIAL FOR EXPLOSION**

- Only use this equipment in non-hazardous locations or in locations that comply either with the Class I, Division 2, Groups A, B, C and D, or with the ATEX Group II, Zone 2 specifications for hazardous locations, depending on your local and/or national regulations.
- Do not substitute components which would impair compliance to the hazardous location specifications of this equipment.
- Do not connect or disconnect equipment unless power has been removed or the location is known to be non-hazardous.

**Failure to follow these instructions will result in death or serious injury.**

**NOTE:** Additional equipment used in conjunction with the equipment described herein must also be suitable for the operating location.

#### **DANGER**

##### **FIRE HAZARD**

Use cable sizes that meet the I/O channel and power supply voltage and current ratings.

**Failure to follow these instructions will result in death or serious injury.**

#### **WARNING**

##### **UNINTENDED EQUIPMENT OPERATION**

Do not exceed any of the rated values specified in the environmental and electrical characteristics tables.

**Failure to follow these instructions can result in death, serious injury, or equipment damage.**

The table below provides the general characteristics of the TM7BAI4VLA block:

General characteristics	
Rated power supply voltage	24 Vdc
Power supply range	18...30 Vdc
24 Vdc I/O power segment current draw	125 mA
TM7 power bus current draw	38 mA
Protection	Against reverse polarity
Power dissipation	3.8 W max.
Weight	200 g (7.05 oz.)
ID code	5873 dec

See also Environmental Characteristics ([see page 21](#)).

### Input Characteristics

The table below provides the input characteristics of the TM7BAI4VLA block:

Input characteristics		
Number of input channels	4	
Wiring type	2 wires	
Input range	-10...+10 Vdc	
Input type	Differential	
Input impedance	20 M $\Omega$ min.	
Sample duration time	400 $\mu$ s for all inputs	
Conversion mode	Successive Approximative Register	
Input filter	Cut-off frequency	1 kHz
	Attenuation	40 dB
Common mode rejection	DC	50 dB min.
	50 Hz	50 dB min.
Input tolerance - maximum deviation at ambient 25° C (77°F)	< 0.1% of the measurement	
Input tolerance - temperature drift	0.011% / °C (0.006% / °F) of the measurement	
Input tolerance - non linearity	< 0.1% of the full scale (20 Vdc)	
Digital resolution	11 bits + sign	
Resolution value	4.882 mV	
Crosstalk rejection between channels	70 dB min.	
Isolation between channels	Not isolated	

Input characteristics	
Isolation between channels and bus	See note <sup>1</sup>
Permitted input signal	±30 Vdc max.
Input protection	Protection against wiring with 24 Vdc supply voltage

<sup>1</sup> The isolation of the block is 500 Vac RMS between the electronics powered by the TM7 power bus and those powered by the 24 Vdc I/O power segment connected to the block. In practice, there is a bridge between the TM7 power bus and the 24 Vdc I/O power segment. The two power circuits reference the same functional ground (FE) through specific components designed to reduce effects of electromagnetic interference. These components are rated at 30 Vdc or 60 Vdc. This effectively reduces isolation of the entire system from the 500 Vac RMS.

### Sensor Supply

The table below provides the power supply for the sensors of the TM7BAI4VLA block:

Supply	
Voltage	24 Vdc I/O power segment supply less voltage drop for internal protection
Voltage drop for internal protection at 500 mA	2 Vdc max.
Supply current (for all powered connected sensors)	500 mA max.
Internal protection	Overcurrent and short circuit



## TM7BAI4VLA Wiring Diagram

### Pin Assignments

The following figure shows the pin assignments for the input connectors of the TM7BAI4VLA block:

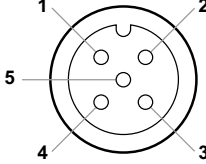
Connection	Pin	M12 input
	1	24 Vdc sensor supply
	2	Analog input +
	3	0 Vdc
	4	Analog input -
	5	Shield

## **⚠ DANGER**

### **FIRE HAZARD**

Use cable sizes that meet the I/O channel and power supply voltage and current ratings.

**Failure to follow these instructions will result in death or serious injury.**

If you do not properly wire the cable, you could introduce electromagnetic interference into the I/O block.

## **⚠ WARNING**

### **ELECTROMAGNETIC INTERFERENCE**

- Do not connect cables to connectors that are not properly wired to the sensor or actuator.
- Always use sealing plugs for any unused connectors.

**Failure to follow these instructions can result in death, serious injury, or equipment damage.**

Use shielded, properly grounded cables for all analog and high-speed inputs or outputs and communication connections. If you do not use shielded cable for these connections, electromagnetic interference can cause signal degradation. Degraded signals can cause the controller or attached modules and equipment to perform in an unintended manner.

** WARNING**

**UNINTENDED EQUIPMENT OPERATION**

- Use shielded cables for all fast I/O, analog I/O and communication signals.
- Ground cable shields for all analog I/O, fast I/O and communication signals at a single point<sup>1</sup>.
- Route communication and I/O cables separately from power cables.

**Failure to follow these instructions can result in death, serious injury, or equipment damage.**

<sup>1</sup>Multipoint grounding is permissible if connections are made to an equipotential ground plane dimensioned to help avoid cable shield damage in the event of power system short-circuit currents.

** WARNING**

**IP67 NON-CONFORMANCE**

- Properly fit all connectors with cables or sealing plugs and tighten for IP67 conformance according to the torque values as specified in this document.
- Do not connect or disconnect cables or sealing plugs in the presence of water or moisture.

**Failure to follow these instructions can result in death, serious injury, or equipment damage.**

---

## Section 3.2

### TM7BAI4CLA Block 4AI 0-20 mA

---

#### What Is in This Section?

This section contains the following topics:

Topic	Page
TM7BAI4CLA Presentation	52
TM7BAI4CLA Characteristics	55
TM7BAI4CLA Wiring Diagram	58

## TM7BAI4CLA Presentation

### Main Characteristics

The table below provides the main characteristics of the TM7BAI4CLA block:

Main characteristics	
Number of input channels	4
Signal type	Current
Input range	0...20 mA
Resolution	12 bits
Sensor connection type	M12, A coded, female connector type (see page 58)

### Description

The following figure shows the TM7BAI4CLA block:

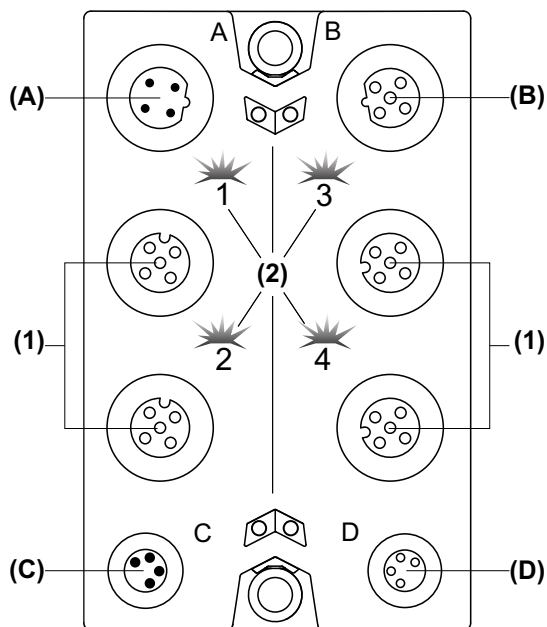

- (A) TM7 bus IN connector
- (B) TM7 bus OUT connector
- (C) 24 Vdc power IN connector
- (D) 24 Vdc power OUT connector
- (1) Input connectors
- (2) Status LEDs

### Connector and Channel Assignments

The table below provides the connector and channel assignments of the TM7BAI4CLA block:

Input connectors	Input status LEDs	Channel type	Channels
1	1	Input	I0
2	2	Input	I1
3	3	Input	I2
4	4	Input	I3

### Status LEDs

The following figure shows the status LEDs of the TM7BAI4CLA block:

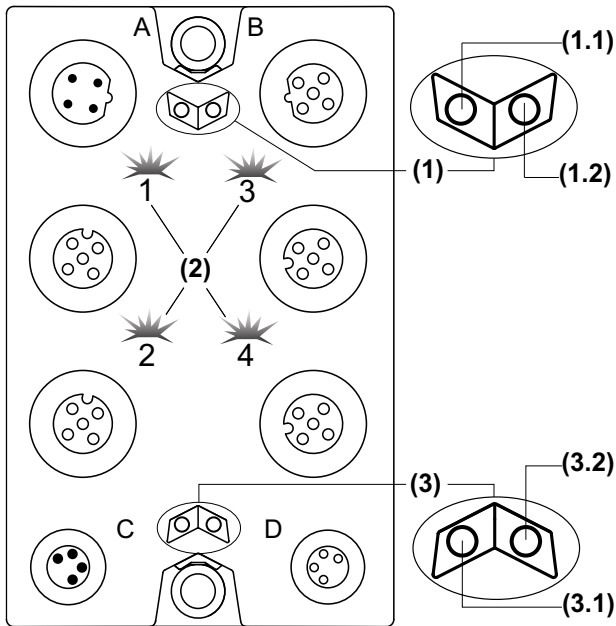

- (1) TM7 bus status LEDs, set of two LEDs: 1.1 (green) and 1.2 (red)
- (2) Input status LEDs, composed of four LEDs: 1, 2, 3 and 4 (green)
- (3) Input block status LEDs, set of two LEDs: 3.1 (green) and 3.2 (red)

The table below provides describes the TM7 bus status LEDs of the TM7BAI4CLA block:

TM7 bus status LEDs		Description
LED 1.1	LED 1.2	
OFF	OFF	No power supply on TM7 bus
ON	ON	TM7 bus in preoperational state: <ul style="list-style-type: none"> <li>● power supply on TM7 bus and</li> <li>● block not initialized</li> </ul>
ON	OFF	TM7 bus in operational state
OFF	ON	TM7 bus error detected

The table below provides the input status LEDs of the TM7BAI4CLA block:

Channel LEDs	State	Description
1 - 4	OFF	Open connection or sensor is disconnected
	Flashing	Overflow or underflow of the input signal
	ON	The analog/digital converter is running, a value is available

The table below provides the input block status LEDs of the TM7BAI4CLA block:

Block Status LEDs	State	Description
3.1	OFF	No power supply
	Single Flash	Reset state
	Flashing	Preoperational state
	ON	Operational state
3.2	OFF	OK or no power supply
	Single Flash	Detected error for an input channel
	Double Flash	Power supply not in the valid range
	ON	Detected error or reset state

## TM7BAI4CLA Characteristics

### General Characteristics

#### DANGER

##### POTENTIAL FOR EXPLOSION

- Only use this equipment in non-hazardous locations or in locations that comply either with the Class I, Division 2, Groups A, B, C and D, or with the ATEX Group II, Zone 2 specifications for hazardous locations, depending on your local and/or national regulations.
- Do not substitute components which would impair compliance to the hazardous location specifications of this equipment.
- Do not connect or disconnect equipment unless power has been removed or the location is known to be non-hazardous.

**Failure to follow these instructions will result in death or serious injury.**

**NOTE:** Additional equipment used in conjunction with the equipment described herein must also be suitable for the operating location.

#### DANGER

##### FIRE HAZARD

Use cable sizes that meet the I/O channel and power supply voltage and current ratings.

**Failure to follow these instructions will result in death or serious injury.**

#### WARNING

##### UNINTENDED EQUIPMENT OPERATION

Do not exceed any of the rated values specified in the environmental and electrical characteristics tables.

**Failure to follow these instructions can result in death, serious injury, or equipment damage.**

The table below provides the general characteristics of the TM7BAI4CLA block:

General characteristics	
Rated power supply voltage	24 Vdc
Power supply range	18...30 Vdc
24 Vdc I/O power segment current draw	125 mA
TM7 power bus current draw	38 mA
Protection	Against reverse polarity
Power dissipation	3.8 W max.
Weight	200 g (7.05 oz.)
ID code	5874 dec

See also Environmental Characteristics ([see page 21](#)).

### Input Characteristics

The table below provides the input characteristics of the TM7BAI4CLA block:

Input characteristics		
Number of input channels	4	
Wiring type	2 wires	
Input range	0...20 mA	
Input type	Differential	
Input load	300 Ω max.	
Voltage drop at 20 mA	4.5 Vdc	
Sample duration time	400 μs for all inputs	
Input type	Differential	
Conversion mode	Successive Approximative Register	
Input filter	Cut-off frequency	1 kHz
	Attenuation	40 dB
Input tolerance - maximum deviation at ambient 25° C (77°F)	< 0.1% of the measurement	
Input tolerance - temperature drift	0.013% / °C (0.007% / °F) of the measurement	
Input tolerance - non linearity	< 0.1% of the full scale (20 mA)	
Digital resolution	12 bits	
Resolution value	4.883 μA	



Input characteristics		
Common mode rejection	DC	50 dB min.
	50 Hz	50 dB min.
Crosstalk rejection between channels	70 dB min.	
Isolation between channels	Not isolated	
Isolation between channels and bus	See note <sup>1</sup>	
Permitted input signal	±30 Vdc max.	
Input protection	Protection against wiring with 24 Vdc supply voltage	

<sup>1</sup> The isolation of the block is 500 Vac RMS between the electronics powered by the TM7 power bus and those powered by the 24 Vdc I/O power segment connected to the block. In practice, there is a bridge between the TM7 power bus and the 24 Vdc I/O power segment. The two power circuits reference the same functional ground (FE) through specific components designed to reduce effects of electromagnetic interference. These components are rated at 30 Vdc or 60 Vdc. This effectively reduces isolation of the entire system from the 500 Vac RMS.

### Sensor Supply

The table below provides the power supply for the sensors of the TM7BAI4CLA block:

Supply	
Voltage	24 Vdc I/O power segment supply less voltage drop for internal protection
Voltage drop for internal protection at 500 mA	2 Vdc max.
Supply current (for all powered connected sensors)	500 mA max.
Internal protection	Overcurrent and short circuit

## TM7BAI4CLA Wiring Diagram

### Pin Assignments

The following figure shows the pin assignments for the input connectors of the TM7BAI4CLA block:

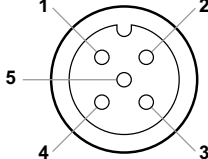
Connection	Pin	M12 input
	1	24 Vdc sensor supply
	2	Analog input +
	3	0 Vdc
	4	Analog input -
	5	Shield

## DANGER

### FIRE HAZARD

Use cable sizes that meet the I/O channel and power supply voltage and current ratings.

**Failure to follow these instructions will result in death or serious injury.**

If you do not properly wire the cable, you could introduce electromagnetic interference into the I/O block.

## WARNING

### ELECTROMAGNETIC INTERFERENCE

- Do not connect cables to connectors that are not properly wired to the sensor or actuator.
- Always use sealing plugs for any unused connectors.

**Failure to follow these instructions can result in death, serious injury, or equipment damage.**

Use shielded, properly grounded cables for all analog and high-speed inputs or outputs and communication connections. If you do not use shielded cable for these connections, electromagnetic interference can cause signal degradation. Degraded signals can cause the controller or attached modules and equipment to perform in an unintended manner.

** WARNING****UNINTENDED EQUIPMENT OPERATION**

- Use shielded cables for all fast I/O, analog I/O and communication signals.
- Ground cable shields for all analog I/O, fast I/O and communication signals at a single point<sup>1</sup>.
- Route communication and I/O cables separately from power cables.

**Failure to follow these instructions can result in death, serious injury, or equipment damage.**

<sup>1</sup>Multipoint grounding is permissible if connections are made to an equipotential ground plane dimensioned to help avoid cable shield damage in the event of power system short-circuit currents.

** WARNING****IP67 NON-CONFORMANCE**

- Properly fit all connectors with cables or sealing plugs and tighten for IP67 conformance according to the torque values as specified in this document.
- Do not connect or disconnect cables or sealing plugs in the presence of water or moisture.

**Failure to follow these instructions can result in death, serious injury, or equipment damage.**



---

# Chapter 4

## TM7BAI4•LA Analog Temperature Input Blocks

---

### What Is in This Chapter?

This chapter contains the following sections:

Section	Topic	Page
4.1	TM7BAI4TLA Block 4AI PT100/PT1000	62
4.2	TM7BAI4PLA Block 4AI Thermocouple J/K/S	72

# Section 4.1

## TM7BAI4TLA Block 4AI PT100/PT1000

---

### What Is in This Section?

This section contains the following topics:

Topic	Page
TM7BAI4TLA Presentation	63
TM7BAI4TLA Characteristics	66
TM7BAI4TLA Wiring Diagram	69

## TM7BAI4TLA Presentation

### Main Characteristics

The table below provides the main characteristics of the TM7BAI4TLA block:

Main characteristics	
Number of input channels	4
Measurement type	Temperature
Input sensor type	PT100 / PT1000 KTY10 / KTY84 (silicon sensor)
Resolution	16 bits
Sensor connection type	M12, A coded, female connector type ( <i>see page 69</i> )

### Description

The following figure shows the TM7BAI4TLA block:

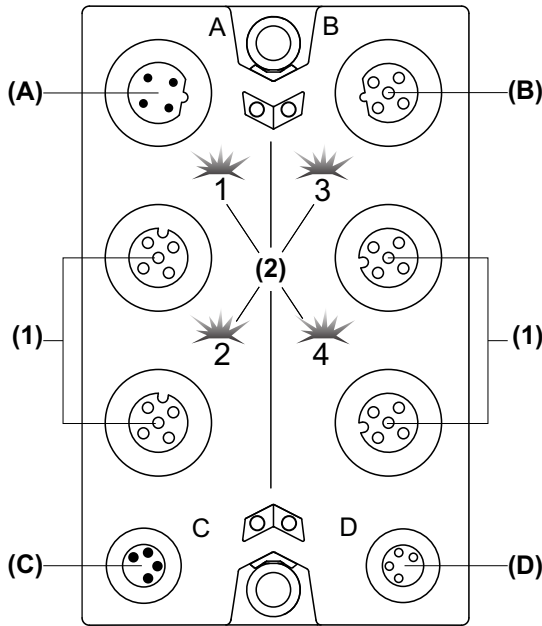

- (A) TM7 bus IN connector
- (B) TM7 bus OUT connector
- (C) 24 Vdc power IN connector
- (D) 24 Vdc power OUT connector
- (1) Input connectors
- (2) Status LEDs

### Connector and Channel Assignments

The table below provides the connector and channel assignments of the TM7BAI4TLA block:

Input connectors	Input status LEDs	Channel type	Channels
1	1	Input	I0
2	2	Input	I1
3	3	Input	I2
4	4	Input	I3

### Status LEDs

The following figure shows the status LEDs of the TM7BAI4TLA block:

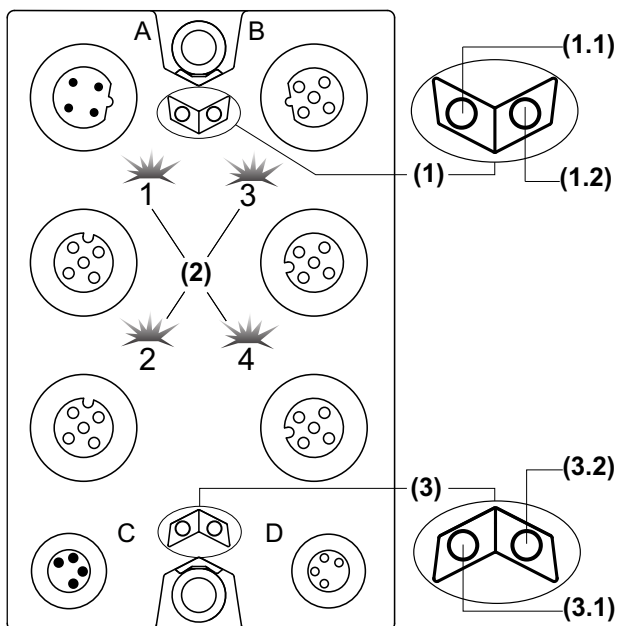

- (1) TM7 bus status LEDs, set of two LEDs: 1.1 (green) and 1.2 (red)
- (2) Input status LEDs, composed of four LEDs: 1, 2, 3 and 4 (green)
- (3) Input block status LEDs, set of two LEDs: 3.1 (green) and 3.2 (red)



The table below provides the TM7 bus status LEDs of the TM7BAI4TLA block:

TM7 bus status LEDs		Description
LED 1.1	LED 1.2	
OFF	OFF	No power supply on TM7 bus
ON	ON	TM7 bus in preoperational state: <ul style="list-style-type: none"> <li>● power supply on TM7 bus and</li> <li>● block not initialized</li> </ul>
ON	OFF	TM7 bus in operational state
OFF	ON	TM7 bus error detected

The table below provides the input status LEDs of the TM7BAI4TLA block:

Channel LEDs	State	Description
1 - 4	OFF	Open connection or sensor is disconnected or not used
	Flashing	Overflow or underflow of the input signal or connection interrupted
	ON	The analog/digital converter is running, a value is available

The table below provides the input block status LEDs of the TM7BAI4TLA block:

Block Status LEDs	State	Description
3.1	OFF	No power supply
	Single Flash	Reset state
	Flashing	Preoperational state
	ON	Operational state
3.2	OFF	OK or no power supply
	Single Flash	Detected error for an input channel.
	Double Flash	Power supply not in the valid range
	ON	Detected error or reset state

## TM7BAI4TLA Characteristics

### General Characteristics

#### **DANGER**

##### **POTENTIAL FOR EXPLOSION**

- Only use this equipment in non-hazardous locations or in locations that comply either with the Class I, Division 2, Groups A, B, C and D, or with the ATEX Group II, Zone 2 specifications for hazardous locations, depending on your local and/or national regulations.
- Do not substitute components which would impair compliance to the hazardous location specifications of this equipment.
- Do not connect or disconnect equipment unless power has been removed or the location is known to be non-hazardous.

**Failure to follow these instructions will result in death or serious injury.**

**NOTE:** Additional equipment used in conjunction with the equipment described herein must also be suitable for the operating location.

#### **DANGER**

##### **FIRE HAZARD**

Use cable sizes that meet the I/O channel and power supply voltage and current ratings.

**Failure to follow these instructions will result in death or serious injury.**

#### **WARNING**

##### **UNINTENDED EQUIPMENT OPERATION**

Do not exceed any of the rated values specified in the environmental and electrical characteristics tables.

**Failure to follow these instructions can result in death, serious injury, or equipment damage.**

The table below provides the general characteristics of the TM7BAI4TLA block:

General characteristics	
Rated power supply voltage	24 Vdc
Power supply range	18...30 Vdc
24 Vdc I/O power segment current draw	63 mA
TM7 power bus current draw	38 mA
Protection	Against reverse polarity
Power dissipation	2.3 W max.
Weight	195 g (6.87 oz.)
ID code	5256 dec

### Input Characteristics

The table below provides the input characteristics of the TM7BAI4TLA block:

Input characteristics		
Number of input channels	4	
Wiring type	2, 3 or 4 wires	
Input sensor type	PT100/PT1000 KTY10/KTY84 (silicon sensor)	
Input temperature range	PT100: -200...850°C (-328...1562°F) PT1000: -200...850°C (-328...1562°F) KTY10: -50...145°C (-58...293°F) KTY84: -40...300°C (-40...572°F)	
Resistance measurement range (software configurable)	1 <sup>st</sup> mode: 0.1...3276 Ω 2 <sup>nd</sup> mode: 0.05...1638 Ω	
Measuring current	250 μA ± 1.25%	
Sample duration time	75 ms per input (with 50 Hz filter) 195 ms per input with different configuration	
Conversion mode	Sigma delta type	
Linearization mode	Software	
Input filter	Cut-off frequency	Low pass 1 <sup>st</sup> order / 115 Hz
	Attenuation	20 dB
	Filter time	2...20 ms using configuration software
Input tolerance - maximum deviation at ambient 25°C (77°F)	0.01% of the measurement	
Input tolerance - temperature drift	0.003% / °C (0.001% / °F) of the measurement	
Input tolerance - non linearity	0.002% of the entire resistance range (4500 Ω)	

Input characteristics		
Digital resolution		16 bits
Resolution value		65536 increments
Resolution temperature value		0.1 °C (0.18°F)
Resolution resistance value		1 <sup>st</sup> mode: 0.1 Ω 2 <sup>nd</sup> mode: 0.05 Ω
Common mode rejection	DC	50 dB min.
	50 Hz	50 dB min.
Crosstalk rejection between channels		70 dB min.
Isolation between channels		Not isolated
Isolation between channels and bus		See note <sup>1</sup>
Input protection		Protection against wiring with 24 Vdc supply voltage

<sup>1</sup> The isolation of the block is 500 Vac RMS between the electronics powered by the TM7 power bus and those powered by the 24 Vdc I/O power segment connected to the block. In practice, there is a bridge between the TM7 power bus and the 24 Vdc I/O power segment. The two power circuits reference the same functional ground (FE) through specific components designed to reduce effects of electromagnetic interference. These components are rated at 30 Vdc or 60 Vdc. This effectively reduces isolation of the entire system from the 500 Vac RMS.

## TM7BAI4TLA Wiring Diagram

### Pin Assignments

The following figure shows the pin assignments for the input connectors of the TM7BAI4TLA block:

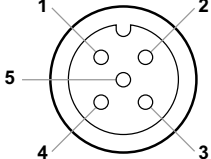
Connection	Pin	M12 input
	1	Sensor +
	2	Sense +
	3	Sensor -
	4	Sense -
	5	Shield

### Wiring Considerations

#### **⚠ DANGER**

##### **FIRE HAZARD**

Use cable sizes that meet the I/O channel and power supply voltage and current ratings.

**Failure to follow these instructions will result in death or serious injury.**

If you do not properly wire the cable, you could introduce electromagnetic interference into the I/O block.

#### **⚠ WARNING**

##### **ELECTROMAGNETIC INTERFERENCE**

- Do not connect cables to connectors that are not properly wired to the sensor or actuator.
- Always use sealing plugs for any unused connectors.

**Failure to follow these instructions can result in death, serious injury, or equipment damage.**

Use shielded, properly grounded cables for all analog and high-speed inputs or outputs and communication connections. If you do not use shielded cable for these connections, electromagnetic interference can cause signal degradation. Degraded signals can cause the controller or attached modules and equipment to perform in an unintended manner.

## ⚠ WARNING

### UNINTENDED EQUIPMENT OPERATION

- Use shielded cables for all fast I/O, analog I/O and communication signals.
- Ground cable shields for all analog I/O, fast I/O and communication signals at a single point<sup>1</sup>.
- Route communication and I/O cables separately from power cables.

**Failure to follow these instructions can result in death, serious injury, or equipment damage.**

<sup>1</sup>Multipoint grounding is permissible if connections are made to an equipotential ground plane dimensioned to help avoid cable shield damage in the event of power system short-circuit currents.

## ⚠ WARNING

### IP67 NON-CONFORMANCE

- Properly fit all connectors with cables or sealing plugs and tighten for IP67 conformance according to the torque values as specified in this document.
- Do not connect or disconnect cables or sealing plugs in the presence of water or moisture.

**Failure to follow these instructions can result in death, serious injury, or equipment damage.**

## 2 Wires Sensor Wiring

The following figure shows the 2 wires sensor and pin assignments for the input connectors of the TM7BAI4TLA block:

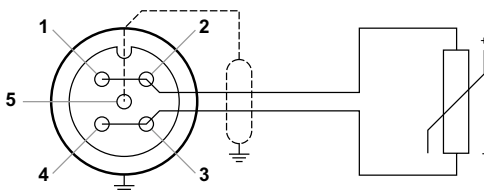

Pin	Description
1	Sensor + ( <sup>1</sup> )
2	Sense + ( <sup>1</sup> )
3	Sensor - ( <sup>2</sup> )

Pin	Description
4	Sense - ( <sup>2</sup> )
5	Shield

The following M12 connector pins must be bridged together:

- <sup>1</sup>: Pins 1 and 2
- <sup>2</sup>: Pins 3 and 4

### 4 Wires Sensor Wiring

The following figure shows the 4 wires sensor and pin assignments for the input connectors of the TM7BAI4TLA block:

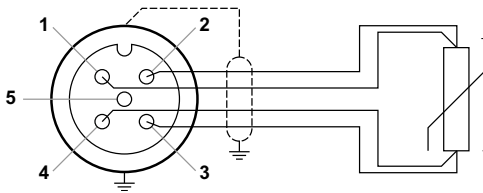

Pin	Description	Color ( <sup>1</sup> )
1	Sensor +	Brown
2	Sense +	White
3	Sensor -	Black
4	Sense -	Blue
5	Shield	–

<sup>1</sup> The colors used are specific to Schneider Electric.

For further information, refer to cable references (see *Modicon TM5 / TM7 Flexible System, System Planning and Installation Guide*)

## ⚠ CAUTION

### INOPERABLE EQUIPMENT

Wire the sensor power supply positive pole to the sensor input positive pole and the sensor power supply negative pole to the sensor input negative pole within the connector.

**Failure to follow these instructions can result in injury or equipment damage.**

## Section 4.2

### TM7BAI4PLA Block 4AI Thermocouple J/K/S

---

#### What Is in This Section?

This section contains the following topics:

Topic	Page
TM7BAI4PLA Presentation	73
TM7BAI4PLA Characteristics	78
TM7BAI4PLA Wiring Diagram	81



## TM7BAI4PLA Presentation

### Main Characteristics

The table below provides the main characteristics of the TM7BAI4PLA block:

Main characteristics	
Number of input channels	4
Measurement type	Temperature
Input sensor type	J, K and S thermocouple sensors
Resolution	16 bits
Sensor connection type	M12, A coded, female connector type ( <i>see page 81</i> )

The thermocouple blocks are configured as a whole for the same type of thermocouple sensor. You cannot mix thermocouple sensor types on the same block, otherwise the temperature readings will not be correct.

### WARNING

#### UNINTENDED EQUIPMENT OPERATION

- Only connect thermocouple sensors of the same type to the temperature block.
- Configure the block for the correct type of thermocouple.

**Failure to follow these instructions can result in death, serious injury, or equipment damage.**

### Description

The following figure shows the TM7BAI4PLA block:

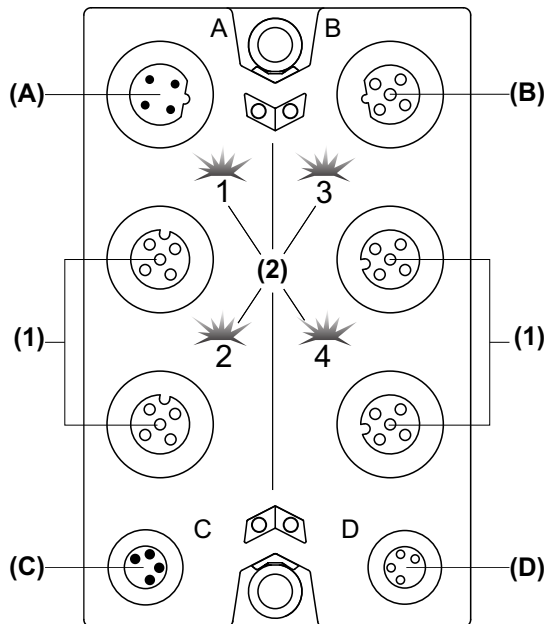

- (A) TM7 bus IN connector
- (B) TM7 bus OUT connector
- (C) 24 Vdc power IN connector
- (D) 24 Vdc power OUT connector
- (1) Input connectors
- (2) Status LEDs

### Connector and Channel Assignments

The table below provides the connector and channel assignments of the TM7BAI4PLA block:

Input connectors	Input status LEDs	Channel type	Channels
1	1	Input	I0
2	2	Input	I1
3	3	Input	I2
4	4	Input	I3

**Status LEDs**

The following figure shows the status LEDs of the TM7BAI4PLA block:

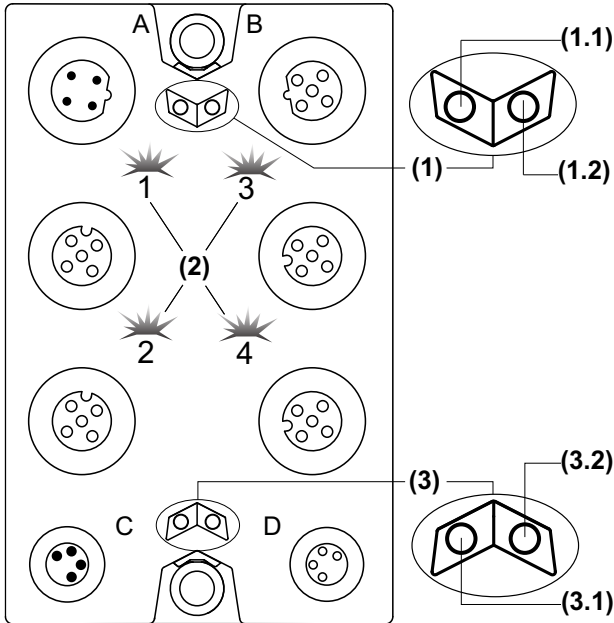

- (1) TM7 bus status LEDs, set of two LEDs: 1.1 (green) and 1.2 (red)
- (2) Input status LEDs, composed of four LEDs: 1, 2, 3 and 4 (green)
- (3) Input block status LEDs, set of two LEDs: 3.1 (green) and 3.2 (red)

The table below provides the TM7 bus status LEDs of the TM7BAI4PLA block:

TM7 bus status LEDs		Description
LED 1.1	LED 1.2	
OFF	OFF	No power supply on TM7 bus
ON	ON	TM7 bus in preoperational state: <ul style="list-style-type: none"> <li>● power supply on TM7 bus and</li> <li>● block not initialized</li> </ul>
ON	OFF	TM7 bus in operational state
OFF	ON	TM7 bus error detected

The table below provides the input status LEDs of the TM7BAI4PLA block:

Channel LEDs	State	Description
1 - 4	OFF	Open connection or sensor is disconnected or not used
	Flashing	Overflow or underflow of the input signal
	ON	The analog/digital converter is running, a value is available

The table below provides the input block status LEDs of the TM7BAI4PLA block:

Block Status LEDs	State	Description
3.1	OFF	No power supply
	Single Flash	Reset state
	Flashing	Preoperational state
	ON	Operational state
3.2	OFF	OK or no power supply
	Single Flash	Detected error for an input channel. Overflow or underflow of the input signal
	Double Flash	Power supply not in the valid range
	ON	Detected error or reset state

### Terminal Temperature (Cold Junction) Compensation

When using thermocouples, it is necessary to measure the temperature at the terminal connections of the TM7BAI4PLA in order to calculate an accurate absolute temperature at the measuring point of the thermocouple. The sensor used to measure the terminal temperature is integrated in the TM7ACTHA thermocouple connector.

**NOTE:** At least one terminal temperature sensor TM7ACTHA is required to determine the temperature measured by the connected thermocouples. Otherwise, a value of 7FFF hex is calculated for all the connected thermocouples.

The accuracy of the temperature measurement of the connected thermocouples is a function of the number of terminal temperature sensors connected to the block.

The table below provides examples for the possible configurations:

TM7ACTHA connected on the input connector	Description
1	The terminal temperature compensation for all 4 channels is performed using the temperature measured on connector 1.
1 and 3	The terminal temperature compensation for channels I0 and I1 is performed using the temperature measured on connector 1. The terminal temperature compensation for channels I2 and I3 is performed using the temperature measured on connector 3.
1, 2, 3 and 4	The terminal temperature compensation is performed using the temperature measured on the respective connector.
<b>NOTE:</b> For the correspondence between the connectors and channels, refer to Connector and Channel Assignments ( <a href="#">see page 74</a> ).	

### TM7ACTHA Presentation

The TM7ACTHA thermocouple plug is used for compensation of the temperature at measurements points. The sensor to measure the terminal temperature is integrated in the thermocouple plug.

The following figure shows the TM7ACTHA:

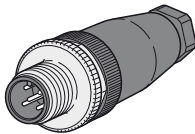

See also TM7ACTHA Characteristics ([see page 80](#)) and Wiring.

## TM7BAI4PLA Characteristics

### General Characteristics

#### **DANGER**

##### **POTENTIAL FOR EXPLOSION**

- Only use this equipment in non-hazardous locations or in locations that comply either with the Class I, Division 2, Groups A, B, C and D, or with the ATEX Group II, Zone 2 specifications for hazardous locations, depending on your local and/or national regulations.
- Do not substitute components which would impair compliance to the hazardous location specifications of this equipment.
- Do not connect or disconnect equipment unless power has been removed or the location is known to be non-hazardous.

**Failure to follow these instructions will result in death or serious injury.**

**NOTE:** Additional equipment used in conjunction with the equipment described herein must also be suitable for the operating location.

#### **DANGER**

##### **FIRE HAZARD**

Use cable sizes that meet the I/O channel and power supply voltage and current ratings.

**Failure to follow these instructions will result in death or serious injury.**

#### **WARNING**

##### **UNINTENDED EQUIPMENT OPERATION**

Do not exceed any of the rated values specified in the environmental and electrical characteristics tables.

**Failure to follow these instructions can result in death, serious injury, or equipment damage.**

The table below provides the general characteristics of the TM7BAI4PLA block:

General characteristics	
Rated power supply voltage	24 Vdc
Power supply range	18...30 Vdc
24 Vdc I/O power segment current draw	108 mA
TM7 power bus current draw	38 mA
Protection	Against reverse polarity
Power dissipation	3.4 W max.
Weight	200 g (7.05 oz.)
ID code	5254 dec

See also Environmental Characteristics ([see page 21](#)).

### Input Characteristics

The table below provides the input characteristics of the TM7BAI4PLA block:

Input characteristics		
Input sensor type	Thermocouple	
Input temperature range	Type J: -210...1200°C (-344...2192°F) Type K: -270...1372°C (-454...2501°F) Type S: -50...1768°C (-56...3214°F)	
Input voltage range (software configurable)	1 <sup>st</sup> mode: ± 65.534 mV 2 <sup>nd</sup> mode: ± 32.765 mV	
Sample duration time	62 ms per input (with 50 Hz filter)	
Sample duration time for terminal temperature measurement	62 ms (with 50 Hz filter)	
Conversion mode	Sigma delta type	
Linearization mode	Software	
Input filter	Cut-off frequency	Low pass 1 <sup>st</sup> order / 4 Hz
	Attenuation	20 dB
	Filter time	2...20 ms using configuration software
Input time	1...66.7 ms configured by software	
Input tolerance - maximum deviation at ambient 25°C (77°F)	Type J: ± 0.064% of the measurement Type K: ± 0.07% of the measurement Type S: ± 0.128% of the measurement	
Input tolerance - temperature drift	0.0123% / °C (0.006% / °F) of the measurement	
Input tolerance - non linearity	± 0.002% of the entire measurement range	

Input characteristics		
Input tolerance - terminal temperature compensation		$\pm 2^{\circ}\text{C}$ ( $35.6^{\circ}\text{F}$ ) after 10 mn
Digital resolution		16-bit
Resolution value		65536 increments
Resolution temperature value		$0.1^{\circ}\text{C}$ ( $0.18^{\circ}\text{F}$ )
Resolution voltage value		1 <sup>st</sup> mode: $2\ \mu\text{V}$ 2 <sup>nd</sup> mode: $1\ \mu\text{V}$
Common mode rejection	DC	70 dB min.
	50 Hz	70 dB min.
Crosstalk rejection between channels		70 dB min.
Isolation between channels		Not isolated
Isolation between channels and bus		See note <sup>1</sup>
Permitted input signal		$\pm 30\ \text{Vdc}$ max.
Input protection		Protection against wiring with 24 Vdc supply voltage

<sup>1</sup> The isolation of the block is 500 Vac RMS between the electronics powered by the TM7 power bus and those powered by the 24 Vdc I/O power segment connected to the block. In practice, there is a bridge between the TM7 power bus and the 24 Vdc I/O power segment. The two power circuits reference the same functional ground (FE) through specific components designed to reduce effects of electromagnetic interference. These components are rated at 30 Vdc or 60 Vdc. This effectively reduces isolation of the entire system from the 500 Vac RMS.

### TM7ACTHA Characteristics

The table below provides the TM7ACTHA thermocouple plug characteristics:

TM7ACTHA thermocouple plug characteristics	
Connector type	M12, A coded 5-pin, male, straight connector type
Compensation sensor	PT1000
Internal terminal type	Screw



## TM7BAI4PLA Wiring Diagram

### Pin Assignments

The following figure shows the pin assignments for the input connectors and terminal temperature compensation of the TM7BAI4PLA:

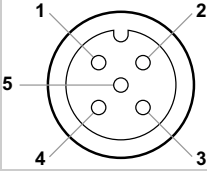
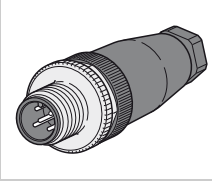
Pin	M12 input connectors	TM7BAI4PLA thermocouple plug
		
1	N.C.	Temperature compensation input
2	Analog input +	Analog input +
3	0 Vdc	0 Vdc
4	Analog input -	Analog input -
5	Shield	Shield

## **⚠ DANGER**

### **FIRE HAZARD**

Use cable sizes that meet the I/O channel and power supply voltage and current ratings.

**Failure to follow these instructions will result in death or serious injury.**

If you do not properly wire the cable, you could introduce electromagnetic interference into the I/O block.

## **⚠ WARNING**

### **ELECTROMAGNETIC INTERFERENCE**

- Do not connect cables to connectors that are not properly wired to the sensor or actuator.
- Always use sealing plugs for any unused connectors.

**Failure to follow these instructions can result in death, serious injury, or equipment damage.**

Use shielded, properly grounded cables for all analog and high-speed inputs or outputs and communication connections. If you do not use shielded cable for these connections, electromagnetic interference can cause signal degradation. Degraded signals can cause the controller or attached modules and equipment to perform in an unintended manner.

** WARNING**

**UNINTENDED EQUIPMENT OPERATION**

- Use shielded cables for all fast I/O, analog I/O and communication signals.
- Ground cable shields for all analog I/O, fast I/O and communication signals at a single point<sup>1</sup>.
- Route communication and I/O cables separately from power cables.

**Failure to follow these instructions can result in death, serious injury, or equipment damage.**

<sup>1</sup>Multipoint grounding is permissible if connections are made to an equipotential ground plane dimensioned to help avoid cable shield damage in the event of power system short-circuit currents.

** WARNING**

**IP67 NON-CONFORMANCE**

- Properly fit all connectors with cables or sealing plugs and tighten for IP67 conformance according to the torque values as specified in this document.
- Do not connect or disconnect cables or sealing plugs in the presence of water or moisture.

**Failure to follow these instructions can result in death, serious injury, or equipment damage.**

---

# Part III

## TM7 System Analog Output Blocks

---



---

# Chapter 5

## TM7BAO4•LA Analog Output Blocks

---

### What Is in This Chapter?

This chapter contains the following sections:

Section	Topic	Page
5.1	TM7BAO4VLA Block 4AO $\pm 10$ Vdc	86
5.2	TM7BAO4CLA Block 4AO 0-20 mA	95

## Section 5.1

### TM7BAO4VLA Block 4AO $\pm 10$ Vdc

---

#### What Is in This Section?

This section contains the following topics:

Topic	Page
TM7BAO4VLA Presentation	87
TM7BAO4VLA Characteristics	90
TM7BAO4VLA Wiring Diagram	93

## TM7BAO4VLA Presentation

### Main Characteristics

The table below provides the main characteristics of the TM7BAO4VLA block:

Main characteristics	
Number of output channels	4
Signal type	Voltage
Output range	-10...+10 Vdc
Resolution	11 bits + sign
Actuator connection type	M12, A coded, female connector type (see page 93)

### Description

The following figure shows the TM7BAO4VLA block:

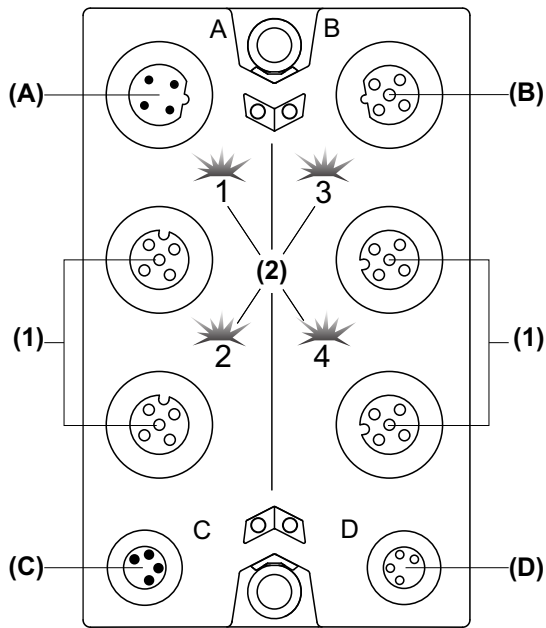

- (A) TM7 bus IN connector
- (B) TM7 bus OUT connector
- (C) 24 Vdc power IN connector
- (D) 24 Vdc power OUT connector
- (1) Output connectors
- (2) Status LEDs

### Connector and Channel Assignments

The table below provides the connector and channel assignments of the TM7BAO4VLA block:

Output connectors	Output status LEDs	Channel type	Channels
1	1	Output	Q0
2	2	Output	Q1
3	3	Output	Q2
4	4	Output	Q3

### Status LEDs

The following figure shows the status LEDs of the TM7BAO4VLA block:

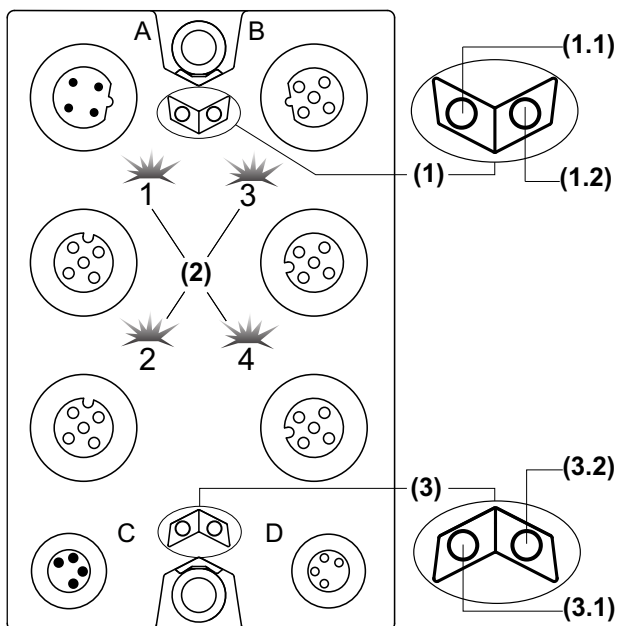

- (1) TM7 bus status LEDs, set of two LEDs: 1.1 (green) and 1.2 (red)
- (2) Output status LEDs, composed of four LEDs: 1, 2, 3 and 4 (yellow)
- (3) Output block status LEDs, set of two LEDs: 3.1 (green) and 3.2 (red)



The table below provides the TM7 bus status LEDs of the TM7BAO4VLA block:

TM7 bus status LEDs		Description
LED 1.1	LED 1.2	
OFF	OFF	No power supply on TM7 bus
ON	ON	TM7 bus in preoperational state: <ul style="list-style-type: none"> <li>● power supply on TM7 bus and</li> <li>● block not initialized</li> </ul>
ON	OFF	TM7 bus in operational state
OFF	ON	TM7 bus error detected

The table below provides the output status LEDs of the TM7BAO4VLA block:

Channel LEDs	State	Description
1 - 4	OFF	Open connection or actuator is disconnected
	ON	The analog/digital converter is running, a value is available

The table below provides the output block status LEDs of the TM7BAO4VLA block:

Block status LEDs	State	Description
3.1	OFF	No power supply
	Single Flash	Reset state
	Flashing	Preoperational state
	ON	Operational state
3.2	OFF	OK or no power supply
	Double Flash	Power supply not in the valid range
	ON	Detected error or reset state

## TM7BAO4VLA Characteristics

### General Characteristics

#### **DANGER**

##### **POTENTIAL FOR EXPLOSION**

- Only use this equipment in non-hazardous locations or in locations that comply either with the Class I, Division 2, Groups A, B, C and D, or with the ATEX Group II, Zone 2 specifications for hazardous locations, depending on your local and/or national regulations.
- Do not substitute components which would impair compliance to the hazardous location specifications of this equipment.
- Do not connect or disconnect equipment unless power has been removed or the location is known to be non-hazardous.

**Failure to follow these instructions will result in death or serious injury.**

**NOTE:** Additional equipment used in conjunction with the equipment described herein must also be suitable for the operating location.

#### **DANGER**

##### **FIRE HAZARD**

Use cable sizes that meet the I/O channel and power supply voltage and current ratings.

**Failure to follow these instructions will result in death or serious injury.**

#### **WARNING**

##### **UNINTENDED EQUIPMENT OPERATION**

Do not exceed any of the rated values specified in the environmental and electrical characteristics tables.

**Failure to follow these instructions can result in death, serious injury, or equipment damage.**

The table below provides the general characteristics of the TM7BAO4VLA block:

General characteristics	
Rated power supply voltage	24 Vdc
Power supply range	18...30 Vdc
24 Vdc I/O power segment current draw	167 mA
TM7 power bus current draw	38 mA
Protection	Against reverse polarity
Power dissipation	3.8 W max.
Weight	200 g (7.05 oz.)
ID code	5875 dec

See also Environmental Characteristics ([see page 21](#)).

### Output Characteristics

The table below provides the output characteristics of the TM7BAO4VLA block:

Output characteristics		
Number of output channels	4	
Wiring type	2 or 4 wires	
Output range	-10...10 Vdc	
Load impedance	1 k $\Omega$ min.	
Rated current	$\pm$ 10 mA max.	
Current limitation	$\pm$ 40 mA max.	
Sample duration time	400 $\mu$ s for all outputs	
Setting time	1 ms of the full scale (20 Vdc)	
Output filter	Cut-off frequency	2.5 kHz
	Type	Low pass 1 <sup>st</sup> order
Output tolerance - maximum deviation at ambient 25° C (77°F)	< 0.15% of the measurement	
Output tolerance - temperature drift	0.015% / °C (0.008% / °F) of the measurement	
Output tolerance - non linearity	< 0.15% of the full scale (20 Vdc)	
Output tolerance - maximum deviation caused by load	< 0.01% (from 10 M $\Omega$ to 1k $\Omega$ , resistive)	
Digital resolution	11 bits + sign	
Resolution value	4.882 mV	
Isolation between channels	Not isolated	

Output characteristics	
Isolation between channels and bus	See note <sup>1</sup>
Output protection	Protection against wiring with 24 Vdc supply voltage and short-circuit

<sup>1</sup> The isolation of the block is 500 Vac RMS between the electronics powered by the TM7 power bus and those powered by the 24 Vdc I/O power segment connected to the block. In practice, there is a bridge between the TM7 power bus and the 24 Vdc I/O power segment. The two power circuits reference the same functional ground (FE) through specific components designed to reduce effects of electromagnetic interference. These components are rated at 30 Vdc or 60 Vdc. This effectively reduces isolation of the entire system from the 500 Vac RMS.

### Actuator Supply

The table below provides the actuators supply of the TM7BAO4VLA block:

Supply	
Voltage	24 Vdc I/O power segment supply less voltage drop for internal protection
Voltage drop for internal protection at 500 mA	2 Vdc max.
Supply current (for all powered connected actuators)	500 mA max.
Internal protection	Overcurrent and short circuit

## TM7BAO4VLA Wiring Diagram

### Pin Assignments

The following figure shows the pin assignments for the output connectors of the TM7BAO4VLA block:

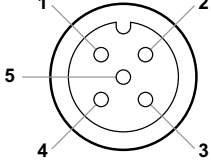
Connection	Pin	M12 Output
	1	Analog output +
	2	24 Vdc actuator supply
	3	Analog output - (0 Vdc)
	4	0 Vdc
	5	Shield

## DANGER

### FIRE HAZARD

Use cable sizes that meet the I/O channel and power supply voltage and current ratings.

**Failure to follow these instructions will result in death or serious injury.**

If you do not properly wire the cable, you could introduce electromagnetic interference into the I/O block.

## WARNING

### ELECTROMAGNETIC INTERFERENCE

- Do not connect cables to connectors that are not properly wired to the sensor or actuator.
- Always use sealing plugs for any unused connectors.

**Failure to follow these instructions can result in death, serious injury, or equipment damage.**

Use shielded, properly grounded cables for all analog and high-speed inputs or outputs and communication connections. If you do not use shielded cable for these connections, electromagnetic interference can cause signal degradation. Degraded signals can cause the controller or attached modules and equipment to perform in an unintended manner.

** WARNING**

**UNINTENDED EQUIPMENT OPERATION**

- Use shielded cables for all fast I/O, analog I/O and communication signals.
- Ground cable shields for all analog I/O, fast I/O and communication signals at a single point<sup>1</sup>.
- Route communication and I/O cables separately from power cables.

**Failure to follow these instructions can result in death, serious injury, or equipment damage.**

<sup>1</sup>Multipoint grounding is permissible if connections are made to an equipotential ground plane dimensioned to help avoid cable shield damage in the event of power system short-circuit currents.

** WARNING**

**IP67 NON-CONFORMANCE**

- Properly fit all connectors with cables or sealing plugs and tighten for IP67 conformance according to the torque values as specified in this document.
- Do not connect or disconnect cables or sealing plugs in the presence of water or moisture.

**Failure to follow these instructions can result in death, serious injury, or equipment damage.**

---

## Section 5.2

### TM7BAO4CLA Block 4AO 0-20 mA

---

#### What Is in This Section?

This section contains the following topics:

Topic	Page
TM7BAO4CLA Presentation	96
TM7BAO4CLA Characteristics	99
TM7BAO4CLA Wiring Diagram	102

## TM7BAO4CLA Presentation

### Main Characteristics

The table below provides the main characteristics of the TM7BAO4CLA block:

Main characteristics	
Number of output channels	4
Signal type	Current
Output range	0...20 mA
Resolution	12 bits
Actuator connection type	M12, A coded, female connector type (see page 102)

### Description

The following figure shows the TM7BAO4CLA block:

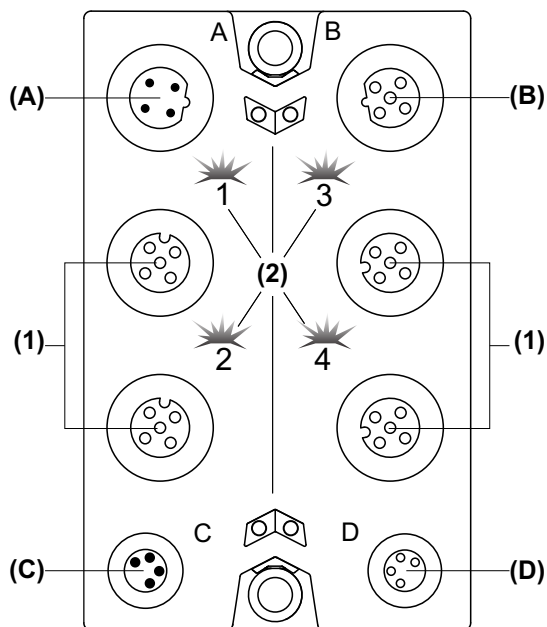

- (A) TM7 bus IN connector
- (B) TM7 bus OUT connector
- (C) 24 Vdc power IN connector
- (D) 24 Vdc power OUT connector
- (1) Output connectors
- (2) Status LEDs



### Connector and Channel Assignments

The table below provides the connector and channel assignments of the TM7BAO4CLA block:

Output connectors	Output status LEDs	Channel type	Channels
1	1	Output	Q0
2	2	Output	Q1
3	3	Output	Q2
4	4	Output	Q3

### Status LEDs

The following figure shows the status LEDs of the TM7BAO4CLA block:

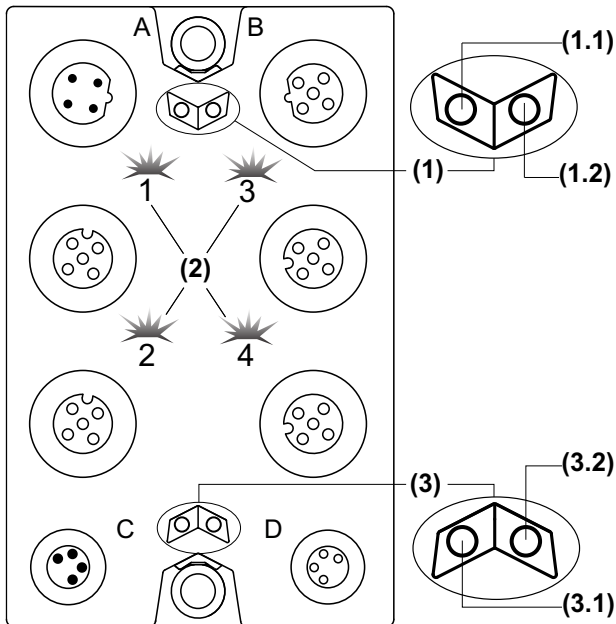

- (1) TM7 bus status LEDs, set of two LEDs: 1.1 (green) and 1.2 (red)
- (2) Output status LEDs, composed of four LEDs: 1, 2, 3 and 4 (yellow)
- (3) Output block status LEDs, set of two LEDs: 3.1 (green) and 3.2 (red)

The table below provides the TM7 bus status LEDs of the TM7BAO4CLA block:

TM7 bus status LEDs		Description
LED 1.1	LED 1.2	
OFF	OFF	No power supply on TM7 bus
ON	ON	TM7 bus in preoperational state: <ul style="list-style-type: none"> <li>● power supply on TM7 bus and</li> <li>● block not initialized</li> </ul>
ON	OFF	TM7 bus in operational state
OFF	ON	TM7 bus error detected

The table below provides the output status LEDs of the TM7BAO4CLA block:

Channel LEDs	State	Description
1 - 4	OFF	Open connection or actuator is disconnected
	ON	The analog/digital converter is running, a value is available

The table below provides the output block status LEDs of the TM7BAO4CLA block:

Block status LEDs	State	Description
3.1	OFF	No power supply
	Single Flash	Reset state
	Flashing	Preoperational state
	ON	Operational state
3.2	OFF	OK or no power supply
	Double Flash	Power supply not in the valid range
	ON	Detected error or reset state

## TM7BAO4CLA Characteristics

### General Characteristics

#### DANGER

##### POTENTIAL FOR EXPLOSION

- Only use this equipment in non-hazardous locations or in locations that comply either with the Class I, Division 2, Groups A, B, C and D, or with the ATEX Group II, Zone 2 specifications for hazardous locations, depending on your local and/or national regulations.
- Do not substitute components which would impair compliance to the hazardous location specifications of this equipment.
- Do not connect or disconnect equipment unless power has been removed or the location is known to be non-hazardous.

**Failure to follow these instructions will result in death or serious injury.**

**NOTE:** Additional equipment used in conjunction with the equipment described herein must also be suitable for the operating location.

#### DANGER

##### FIRE HAZARD

Use cable sizes that meet the I/O channel and power supply voltage and current ratings.

**Failure to follow these instructions will result in death or serious injury.**

#### WARNING

##### UNINTENDED EQUIPMENT OPERATION

Do not exceed any of the rated values specified in the environmental and electrical characteristics tables.

**Failure to follow these instructions can result in death, serious injury, or equipment damage.**

The table below provides the general characteristics of the TM7BAO4CLA block:

General characteristics	
Rated power supply voltage	24 Vdc
Power supply range	18...30 Vdc
24 Vdc I/O Power segment current draw	188 mA
TM7 power bus current draw	38 mA
Protection	Against reverse polarity
Power dissipation	5.3 W max.
Weight	200 g (7.05 oz.)
ID code	5876 (decimal)

See also Environmental Characteristics ([see page 21](#)).

### Output Characteristics

The table below provides the output characteristics of the TM7BAO4CLA block:

Output characteristics		
Number of output channels	4	
Wiring type	2 or 4 wires	
Output range	0...20 mA	
Load impedance	400 Ω max.	
Current limitation	±40 mA max.	
Sample duration time	400 μs for all outputs	
Setting time	1 ms of the full scale (20 mA)	
Output filter	Cut-off frequency	1.5 kHz
	Type	Low pass 1 <sup>st</sup> order
Output tolerance - maximum deviation at ambient 25° C (77°F)	< 0.2% of the measurement	
Output tolerance - temperature drift	0.032% / °C (0.017% / °F) of the measurement	
Output tolerance - non linearity	< 0.1% of the full scale (20 mA)	
Output tolerance - maximum deviation caused by load	< 0.5% (from 1 Ω to 400 Ω, resistive)	
Digital resolution	12 bits	
Resolution value	4.883 μA	
Isolation between channels	Not isolated	

Output characteristics	
Isolation between channels and bus	See note <sup>1</sup>
Output protection	Protection against wiring with 24 Vdc supply voltage and short-circuit

<sup>1</sup> The isolation of the block is 500 Vac RMS between the electronics powered by the TM7 power bus and those powered by the 24 Vdc I/O power segment connected to the block. In practice, there is a bridge between the TM7 power bus and the 24 Vdc I/O power segment. The two power circuits reference the same functional ground (FE) through specific components designed to reduce effects of electromagnetic interference. These components are rated at 30 Vdc or 60 Vdc. This effectively reduces isolation of the entire system from the 500 Vac RMS.

### Actuator Supply

The table below provides the actuators supply of the TM7BAO4CLA block:

Supply	
Voltage	24 Vdc I/O Power segment supply less voltage drop for internal protection
Voltage drop for internal protection at 500 mA	2 Vdc max.
Supply current (for all powered connected actuators)	500 mA max.
Internal protection	Overcurrent and short circuit

## TM7BAO4CLA Wiring Diagram

### Pin Assignments

The following figure shows the pin assignments for the output connectors of the TM7BAO4CLA block:

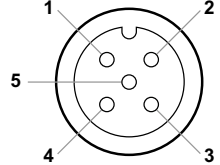
Connection	Pin	M12 Output
	1	Analog output +
	2	24 Vdc actuator supply
	3	Analog output - (0 Vdc)
	4	0 Vdc
	5	Shield

## DANGER

### FIRE HAZARD

Use cable sizes that meet the I/O channel and power supply voltage and current ratings.

**Failure to follow these instructions will result in death or serious injury.**

If you do not properly wire the cable, you could introduce electromagnetic interference into the I/O block.

## WARNING

### ELECTROMAGNETIC INTERFERENCE

- Do not connect cables to connectors that are not properly wired to the sensor or actuator.
- Always use sealing plugs for any unused connectors.

**Failure to follow these instructions can result in death, serious injury, or equipment damage.**

Use shielded, properly grounded cables for all analog and high-speed inputs or outputs and communication connections. If you do not use shielded cable for these connections, electromagnetic interference can cause signal degradation. Degraded signals can cause the controller or attached modules and equipment to perform in an unintended manner.

## **WARNING**

### **UNINTENDED EQUIPMENT OPERATION**

- Use shielded cables for all fast I/O, analog I/O and communication signals.
- Ground cable shields for all analog I/O, fast I/O and communication signals at a single point<sup>1</sup>.
- Route communication and I/O cables separately from power cables.

**Failure to follow these instructions can result in death, serious injury, or equipment damage.**

<sup>1</sup>Multipoint grounding is permissible if connections are made to an equipotential ground plane dimensioned to help avoid cable shield damage in the event of power system short-circuit currents.

## **WARNING**

### **IP67 NON-CONFORMANCE**

- Properly fit all connectors with cables or sealing plugs and tighten for IP67 conformance according to the torque values as specified in this document.
- Do not connect or disconnect cables or sealing plugs in the presence of water or moisture.

**Failure to follow these instructions can result in death, serious injury, or equipment damage.**





---

# Part IV

## TM7 System Analog Mixed Blocks

---



---

# Chapter 6

## TM7BAM4•LA Analog Mixed Blocks

---

### What Is in This Chapter?

This chapter contains the following sections:

Section	Topic	Page
6.1	TM7BAM4VLA Block 2AI/2AO $\pm 10$ Vdc	108
6.2	TM7BAM4CLA Block 2AI/2AO 0-20 mA	118

# Section 6.1

## TM7BAM4VLA Block 2AI/2AO $\pm 10$ Vdc

---

### What Is in This Section?

This section contains the following topics:

Topic	Page
TM7BAM4VLA Presentation	109
TM7BAM4VLA Characteristics	112
TM7BAM4VLA Wiring Diagram	116

## TM7BAM4VLA Presentation

### Main Characteristics

The table below provides the main characteristics of the TM7BAM4VLA block:

Main characteristics	
Number of input channels	2
Number of output channels	2
Signal type	Voltage
Input range	-10...+10 Vdc
Output range	-10...+10 Vdc
Resolution	11 bits + sign
Sensor and actuator connection type	M12, A coded, female connector type (see page 116)

### Description

The following figure shows the TM7BAM4VLA block:

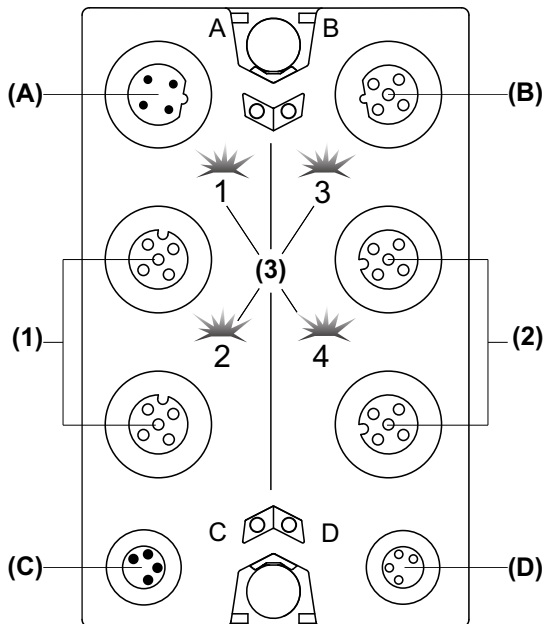

- (A) TM7 bus IN connector
- (B) TM7 bus OUT connector
- (C) 24 Vdc power IN connector
- (D) 24 Vdc power OUT connector
- (1) Input connectors
- (2) Output connectors
- (3) Status LEDs

### Connector and Channel Assignments

The table below provides the connector and channel assignments of the TM7BAM4VLA block. For further information, refer to I/O Configuration Tab:

I/O connectors	I/O status LEDs	Channel type	Channels
1	1	Input	I0
2	2	Input	I1
3	3	Output	Q0
4	4	Output	Q1

### Status LEDs

The following figure shows the status LEDs of the TM7BAM4VLA block:

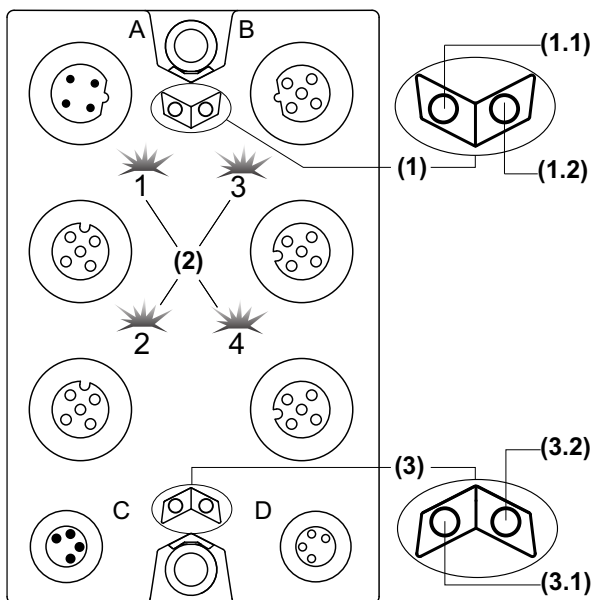

- (1) TM7 bus status LEDs, set of two LEDs: 1.1 (green) and 1.2 (red)
- (2) I/O status LEDs, composed of two sets of two LEDs: 1 and 2 (green), 3 and 4 (yellow)
- (3) I/O block status LEDs, set of two LEDs: 3.1 (green) and 3.2 (red)

The table below provides the TM7 bus status LEDs of the TM7BAM4VLA block:

TM7 bus status LEDs		Description
LEDs 1.1	LEDs 1.2	
OFF	OFF	No power supply on TM7 bus
ON	ON	TM7 bus in preoperational state: <ul style="list-style-type: none"> <li>● power supply on TM7 bus and</li> <li>● block not initialized</li> </ul>
ON	OFF	TM7 bus in operational state
OFF	ON	TM7 bus error detected

The table below provides the I/O status LEDs of the TM7BAM4VLA block:

Channel LEDs	State	Description
1 and 2	OFF	Open connection or sensor/actuator is disconnected
	Flashing	Overflow or underflow of the input signal
	ON	The analog/digital converter is running, a value is available
3 and 4	OFF	The enable relay is not closed yet, there is not any value available other than 0
	ON	The analog/digital converter is running, a value is available

The table below provides the I/O block status LEDs of the TM7BAM4VLA block:

Block status LEDs	State	Description
3.1	OFF	No power supply
	Single Flash	Reset state
	Flashing	Preoperational state
	ON	Operational state
3.2	OFF	OK or no power supply
	Single Flash	Detected error for an I/O channel. Overflow or underflow of the input signal
	Double Flash	Power supply not in the valid range
	ON	Detected error or reset state

## TM7BAM4VLA Characteristics

### General Characteristics

#### **DANGER**

##### **POTENTIAL FOR EXPLOSION**

- Only use this equipment in non-hazardous locations or in locations that comply either with the Class I, Division 2, Groups A, B, C and D, or with the ATEX Group II, Zone 2 specifications for hazardous locations, depending on your local and/or national regulations.
- Do not substitute components which would impair compliance to the hazardous location specifications of this equipment.
- Do not connect or disconnect equipment unless power has been removed or the location is known to be non-hazardous.

**Failure to follow these instructions will result in death or serious injury.**

**NOTE:** Additional equipment used in conjunction with the equipment described herein must also be suitable for the operating location.

#### **DANGER**

##### **FIRE HAZARD**

Use cable sizes that meet the I/O channel and power supply voltage and current ratings.

**Failure to follow these instructions will result in death or serious injury.**

#### **WARNING**

##### **UNINTENDED EQUIPMENT OPERATION**

Do not exceed any of the rated values specified in the environmental and electrical characteristics tables.

**Failure to follow these instructions can result in death, serious injury, or equipment damage.**



The table below provides the general characteristics of the TM7BAM4VLA block:

General characteristics	
Rated power supply voltage	24 Vdc
Power supply range	18...30 Vdc
24 Vdc I/O power segment current draw	125 mA
TM7 power bus current draw	38 mA
Protection	Against reverse polarity
Power dissipation	3.8 W max.
Weight	200 g (7.05 oz.)
ID code	5221 dec

See also Environmental Characteristics ([see page 21](#)).

### Input Characteristics

The table below provides the input characteristics of the TM7BAM4VLA block:

Input characteristics		
Number of input channels	2	
Wiring type	2 or 4 wires	
Input range	-10...+10 Vdc	
Input type	Differential	
Input impedance	20 M $\Omega$ min.	
Sample duration time	400 $\mu$ s for all inputs	
Conversion mode	Successive Approximative Register	
Input filter	Cut-off frequency	300 Hz
	Attenuation	40 dB
Input tolerance - maximum deviation at ambient 25° C (77°F)	< 0.1% of the measurement	
Input tolerance - temperature drift	0.011% / °C (0.006% / °F) of the measurement	
Input tolerance - non linearity	< 0.1% of the full scale (20 Vdc)	
Digital resolution	11 bits + sign	
Resolution value	4.882 mV	
Common mode rejection	DC	50 dB min.
	50 Hz	50 dB min.
Crosstalk rejection between channels	70 dB min.	
Isolation between channels	Not isolated	

Input characteristics	
Isolation between channels and bus	See note <sup>1</sup>
Permitted input signal	±30 Vdc max.
Input protection	Protection against wiring with 24 Vdc supply voltage

<sup>1</sup> The isolation of the block is 500 Vac RMS between the electronics powered by the TM7 power bus and those powered by the 24 Vdc I/O power segment connected to the block. In practice, there is a bridge between the TM7 power bus and the 24 Vdc I/O power segment. The two power circuits reference the same functional ground (FE) through specific components designed to reduce effects of electromagnetic interference. These components are rated at 30 Vdc or 60 Vdc. This effectively reduces isolation of the entire system from the 500 Vac RMS.

### Output Characteristics

The table below provides the output characteristics of the TM7BAM4VLA block:

Output characteristics		
Number of output channels	2	
Wiring type	2 or 4 wires	
Output range	-10... +10 Vdc	
Load impedance	1 kΩ min.	
Rated current	±10 mA max.	
Current limitation	±40 mA max.	
Sample duration time	400 μs for all outputs	
Setting time	1 ms of the full scale (20 Vdc)	
Output filter	Cut-off frequency	2.5 kHz
	Type	Low pass 1 <sup>st</sup> order
Output tolerance - maximum deviation at ambient 25° C (77°F)	< 0.15% of the measurement	
Output tolerance - temperature drift	0.015% / °C (0.008% / °F) of the measurement	
Output tolerance - non linearity	< 0.15% of the full scale (20 Vdc)	
Output tolerance - maximum deviation caused by load	< 0.01% (from 10 MΩ to 1 kΩ, resistive)	
Digital resolution	11 bits + sign	
Resolution value	4.882 mV	
Isolation between channels	Not isolated	

Output characteristics	
Isolation between channels and bus	See note <sup>1</sup>
Output protection	Protection against wiring with 24 Vdc supply voltage and short-circuit

<sup>1</sup> The isolation of the block is 500 Vac RMS between the electronics powered by the TM7 power bus and those powered by the 24 Vdc I/O power segment connected to the block. In practice, there is a bridge between the TM7 power bus and the 24 Vdc I/O power segment. The two power circuits reference the same functional ground (FE) through specific components designed to reduce effects of electromagnetic interference. These components are rated at 30 Vdc or 60 Vdc. This effectively reduces isolation of the entire system from the 500 Vac RMS.

### Sensor and Actuator Supply

The table below provides the power supply for the sensors and actuators of the TM7BAM4VLA block:

Supply	
Voltage	24 Vdc I/O power segment supply less voltage drop for internal protection
Voltage drop for internal protection at 500 mA	2 Vdc max.
Supply current (for all powered connected sensors and actuators)	500 mA max.
Internal protection	Overcurrent and short circuit

## TM7BAM4VLA Wiring Diagram

### Pin Assignments

The following figure shows the pin assignments for the I/O connectors of the TM7BAM4VLA block:

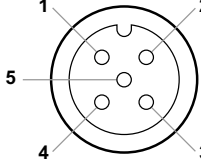
Connection	Pin	M12 Input	M12 Output
	1	24 Vdc sensor supply	Analog output +
	2	Analog input +	24 Vdc actuator supply
	3	0 Vdc	Analog output - (0 Vdc)
	4	Analog input -	0 Vdc
	5	Shield	Shield

### **⚠ DANGER**

#### **FIRE HAZARD**

Use cable sizes that meet the I/O channel and power supply voltage and current ratings.

**Failure to follow these instructions will result in death or serious injury.**

If you do not properly wire the cable, you could introduce electromagnetic interference into the I/O block.

### **⚠ WARNING**

#### **ELECTROMAGNETIC INTERFERENCE**

- Do not connect cables to connectors that are not properly wired to the sensor or actuator.
- Always use sealing plugs for any unused connectors.

**Failure to follow these instructions can result in death, serious injury, or equipment damage.**

Use shielded, properly grounded cables for all analog and high-speed inputs or outputs and communication connections. If you do not use shielded cable for these connections, electromagnetic interference can cause signal degradation. Degraded signals can cause the controller or attached modules and equipment to perform in an unintended manner.

 **WARNING****UNINTENDED EQUIPMENT OPERATION**

- Use shielded cables for all fast I/O, analog I/O and communication signals.
- Ground cable shields for all analog I/O, fast I/O and communication signals at a single point<sup>1</sup>.
- Route communication and I/O cables separately from power cables.

**Failure to follow these instructions can result in death, serious injury, or equipment damage.**

<sup>1</sup>Multipoint grounding is permissible if connections are made to an equipotential ground plane dimensioned to help avoid cable shield damage in the event of power system short-circuit currents.

 **WARNING****IP67 NON-CONFORMANCE**

- Properly fit all connectors with cables or sealing plugs and tighten for IP67 conformance according to the torque values as specified in this document.
- Do not connect or disconnect cables or sealing plugs in the presence of water or moisture.

**Failure to follow these instructions can result in death, serious injury, or equipment damage.**

## Section 6.2

### TM7BAM4CLA Block 2AI/2AO 0-20 mA

---

#### What Is in This Section?

This section contains the following topics:

Topic	Page
TM7BAM4CLA Presentation	119
TM7BAM4CLA Characteristics	122
TM7BAM4CLA Wiring Diagram	126

## TM7BAM4CLA Presentation

### Main Characteristics

The table below provides the main characteristics of the TM7BAM4CLA block:

Main characteristics	
Number of input channels	2
Number of output channels	2
Signal type	Current
Input range	0...20 mA
Output range	0...20 mA
Resolution	12 bits
Sensor / actuator connection type	M12, A coded, female connector type ( <i>see page 126</i> )

### Description

The following figure shows the TM7BAM4CLA block:

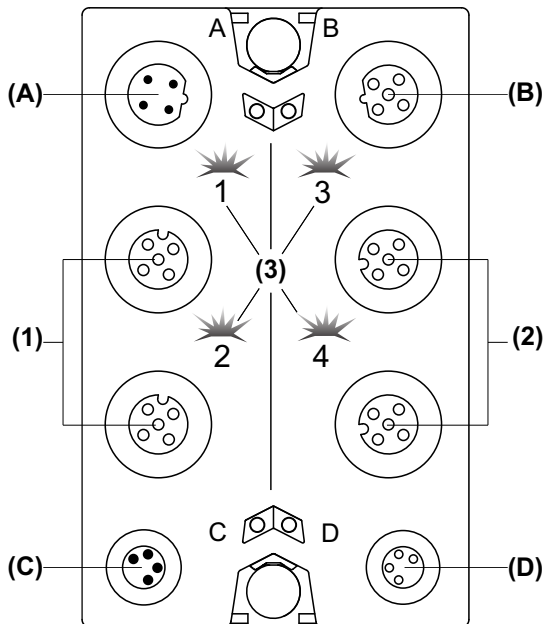

- (A) TM7 bus IN connector
- (B) TM7 bus OUT connector
- (C) 24 Vdc power IN connector
- (D) 24 Vdc power OUT connector
- (1) Input connectors
- (2) Output connectors
- (3) Status LEDs

### Connector and Channel Assignments

The table below provides the connector and channel assignments of the TM7BAM4CLA block. For further information, refer to I/O Configuration Tab:

I/O connectors	I/O status LEDs	Channel type	Channels
1	1	Input	I0
2	2	Input	I1
3	3	Output	Q0
4	4	Output	Q1

### Status LEDs

The following figure shows the status LEDs of the TM7BAM4CLA block:

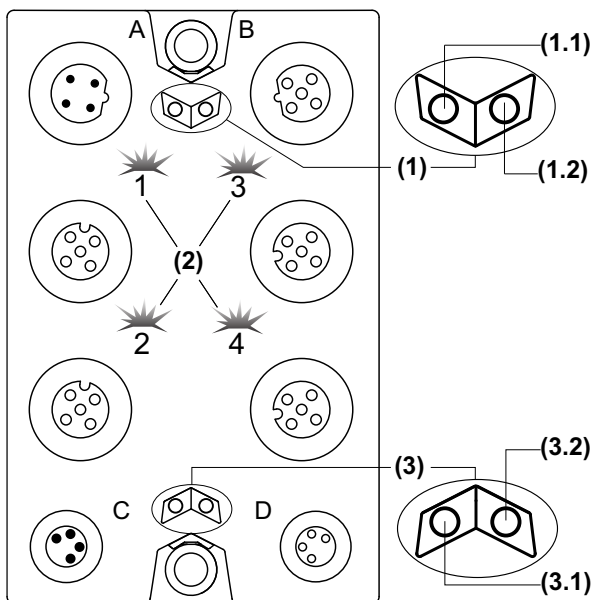

- (1) TM7 bus status LEDs, set of two LEDs: 1.1 (green) and 1.2 (red)
- (2) I/O status LEDs, composed of two sets of two LEDs: 1 and 2 (green), 3 and 4 (yellow)
- (3) I/O block status LEDs, set of two LEDs: 3.1 (green) and 3.2 (red)



The table below provides the TM7 bus status LEDs of the TM7BAM4VLA block:

TM7 bus status LEDs		Description
LEDs 1.1	LEDs 1.2	
OFF	OFF	No power supply on TM7 bus
ON	ON	TM7 bus in preoperational state: <ul style="list-style-type: none"> <li>● power supply on TM7 bus and</li> <li>● block not initialized</li> </ul>
ON	OFF	TM7 bus in operational state
OFF	ON	TM7 bus error detected

The table below provides the I/O status LEDs of the TM7BAM4VLA block:

Channel LEDs	State	Description
1 and 2	OFF	Open connection or sensor/actuator is disconnected
	Flashing	Overflow or underflow of the input signal
	ON	The analog/digital converter is running, a value is available
3 and 4	OFF	The enable relay is not closed yet, there is not any value available other than 0
	ON	The analog/digital converter is running, a value is available

The table below provides the I/O block status LEDs of the TM7BAM4VLA block:

Block status LEDs	State	Description
3.1	OFF	No power supply
	Single Flash	Reset state
	Flashing	Preoperational state
	ON	Operational state
3.2	OFF	OK or no power supply
	Single Flash	Detected error for an I/O channel. Overflow or underflow of the input signal
	Double Flash	Power supply not in the valid range
	ON	Detected error or reset state

## TM7BAM4CLA Characteristics

### General Characteristics

#### DANGER

##### POTENTIAL FOR EXPLOSION

- Only use this equipment in non-hazardous locations or in locations that comply either with the Class I, Division 2, Groups A, B, C and D, or with the ATEX Group II, Zone 2 specifications for hazardous locations, depending on your local and/or national regulations.
- Do not substitute components which would impair compliance to the hazardous location specifications of this equipment.
- Do not connect or disconnect equipment unless power has been removed or the location is known to be non-hazardous.

**Failure to follow these instructions will result in death or serious injury.**

**NOTE:** Additional equipment used in conjunction with the equipment described herein must also be suitable for the operating location.

#### DANGER

##### FIRE HAZARD

Use cable sizes that meet the I/O channel and power supply voltage and current ratings.

**Failure to follow these instructions will result in death or serious injury.**

#### WARNING

##### UNINTENDED EQUIPMENT OPERATION

Do not exceed any of the rated values specified in the environmental and electrical characteristics tables.

**Failure to follow these instructions can result in death, serious injury, or equipment damage.**

The table below provides the general characteristics of the TM7BAM4CLA block:

General characteristics	
Rated power supply voltage	24 Vdc
Power supply range	18...30 Vdc
24 Vdc I/O power segment current draw	125 mA
TM7 power bus current draw	38 mA
Protection	Against reverse polarity
Power dissipation	3.8 W max.
Weight	200 g (7.05 oz.)
ID code	5222 dec

See also Environmental Characteristics ([see page 21](#)).

### Input Characteristics

The table below provides the input characteristics of the TM7BAM4CLA block:

Input characteristics		
Number of input channels	2	
Wiring type	2 or 4 wires	
Input range	0...20 mA	
Input type	Differential	
Input load	300 $\Omega$ max.	
Voltage drop at 20 mA	4.5 Vdc	
Sample duration time	400 $\mu$ s for all inputs	
Conversion mode	Successive Approximative Register	
Input filter	Cut-off frequency	300 Hz
	Attenuation	40 dB
Input tolerance - maximum deviation at ambient 25° C (77°F)	< 0.1% of the measurement	
Input tolerance - temperature drift	0.013% / °C (0.007% / °F) of the measurement	
Input tolerance - non linearity	< 0.1% of the full scale (20 mA)	
Digital resolution	12 bits	
Resolution value	4.883 $\mu$ A	
Common mode rejection	DC	50 dB min.
	50 Hz	50 dB min.
Crosstalk rejection between channels	70 dB min.	

Input characteristics	
Isolation between channels	Not isolated
Isolation between channels and bus	See note <sup>1</sup>
Permitted input signal	±30 Vdc max.
Input protection	Protection against wiring with 24 Vdc supply voltage
Common mode voltage allowable between channels	±30 mA max.

<sup>1</sup> The isolation of the block is 500 Vac RMS between the electronics powered by the TM7 power bus and those powered by the 24 Vdc I/O power segment connected to the block. In practice, there is a bridge between the TM7 power bus and the 24 Vdc I/O power segment. The two power circuits reference the same functional ground (FE) through specific components designed to reduce effects of electromagnetic interference. These components are rated at 30 Vdc or 60 Vdc. This effectively reduces isolation of the entire system from the 500 Vac RMS.

### Output Characteristics

The table below provides the output characteristics of the TM7BAM4CLA block:

Output characteristics		
Number of output channels	2	
Wiring type	2 or 4 wires	
Output range	0...20 mA	
Load impedance	400 Ω max.	
Current limitation	±40 mA max.	
Sample duration time	400 μs for all outputs	
Setting time	1 ms of the full scale (20 mA)	
Output filter	Cut-off frequency	1.5 kHz
	Type	Low pass 1 <sup>st</sup> order
Output tolerance - maximum deviation at ambient 25° C (77°F)	< 0.2% of the measurement	
Output tolerance - temperature drift	0.032% / °C (0.017% / °F) of the measurement	
Output tolerance - non linearity	< 0.1% of the full scale (20 mA)	
Output tolerance - maximum deviation caused by load	< 0.5% (from 1 Ω to 400 Ω, resistive)	
Digital resolution	12 bits	
Resolution value	4.883 μA	
Isolation between channels	Not isolated	

Output characteristics	
Isolation between channels and bus	See note <sup>1</sup>
Output protection	Protection against wiring with 24 Vdc supply voltage and short-circuit

<sup>1</sup> The isolation of the block is 500 Vac RMS between the electronics powered by the TM7 power bus and those powered by the 24 Vdc I/O power segment connected to the block. In practice, there is a bridge between the TM7 power bus and the 24 Vdc I/O power segment. The two power circuits reference the same functional ground (FE) through specific components designed to reduce effects of electromagnetic interference. These components are rated at 30 Vdc or 60 Vdc. This effectively reduces isolation of the entire system from the 500 Vac RMS.

### Sensor / Actuator Supply

The table below provides the sensors and actuators supply of the TM7BAM4CLA block:

Supply	
Voltage	24 Vdc I/O power segment supply less voltage drop for internal protection
Voltage drop for internal protection at 500 mA	2 Vdc max.
Supply current (for all powered connected sensors / actuators)	500 mA max.
Internal protection	Overcurrent and short circuit

## TM7BAM4CLA Wiring Diagram

### Pin Assignments

The following figure shows the pin assignments for the I/O connectors of the TM7BAM4CLA block:

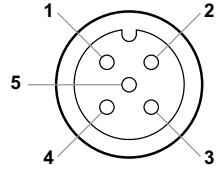
Connection	Pin	M12 Input	M12 Output
	1	24 Vdc sensor supply	Analog output +
	2	Analog input +	24 Vdc actuator supply
	3	0 Vdc	Analog output - (0 Vdc)
	4	Analog input -	0 Vdc
	5	Shield	Shield

## DANGER

### FIRE HAZARD

Use cable sizes that meet the I/O channel and power supply voltage and current ratings.

**Failure to follow these instructions will result in death or serious injury.**

If you do not properly wire the cable, you could introduce electromagnetic interference into the I/O block.

## WARNING

### ELECTROMAGNETIC INTERFERENCE

- Do not connect cables to connectors that are not properly wired to the sensor or actuator.
- Always use sealing plugs for any unused connectors.

**Failure to follow these instructions can result in death, serious injury, or equipment damage.**

Use shielded, properly grounded cables for all analog and high-speed inputs or outputs and communication connections. If you do not use shielded cable for these connections, electromagnetic interference can cause signal degradation. Degraded signals can cause the controller or attached modules and equipment to perform in an unintended manner.

 **WARNING****UNINTENDED EQUIPMENT OPERATION**

- Use shielded cables for all fast I/O, analog I/O and communication signals.
- Ground cable shields for all analog I/O, fast I/O and communication signals at a single point<sup>1</sup>.
- Route communication and I/O cables separately from power cables.

**Failure to follow these instructions can result in death, serious injury, or equipment damage.**

<sup>1</sup>Multipoint grounding is permissible if connections are made to an equipotential ground plane dimensioned to help avoid cable shield damage in the event of power system short-circuit currents.

 **WARNING****IP67 NON-CONFORMANCE**

- Properly fit all connectors with cables or sealing plugs and tighten for IP67 conformance according to the torque values as specified in this document.
- Do not connect or disconnect cables or sealing plugs in the presence of water or moisture.

**Failure to follow these instructions can result in death, serious injury, or equipment damage.**





---

# Glossary

---



## A

### **analog input**

Converts received voltage or current levels into numerical values. You can store and process these values within the logic controller.

### **analog output**

Converts numerical values within the logic controller and sends out proportional voltage or current levels.

### **A coded**

Connectors that have 1 raised key on the male connector and 1 mating slot on the female connector. This is the standard coding used for sensors and distribution box applications.

## C

### **crosstalk**

An undesired signal caused by a capacitive, inductive, or conductive coupling between 2 channels.

## D

### **DIN**

(*Deutsches Institut für Normung*) A German institution that sets engineering and dimensional standards.

## E

### **EN**

EN identifies one of many European standards maintained by CEN (*European Committee for Standardization*), CENELEC (*European Committee for Electrotechnical Standardization*), or ETSI (*European Telecommunications Standards Institute*).

## I

### IEC

(*international electrotechnical commission*) A non-profit and non-governmental international standards organization that prepares and publishes international standards for electrical, electronic, and related technologies.

### input filter

A special function that helps reject extraneous signals on input lines due to such things as contact bounce and inducted electrical transients. Inputs provide a level of input filtering using the hardware. Additional filtering with software is also configurable through the programing or the configuration software.

### IP 67

(*ingress protection*) The protection classification according to IEC 60529. IP 67 modules are protected against ingress of dust, contact, and water up to an immersion depth of 1 m.

## P

### Pt100/Pt1000

(*platinum 100/1000*) Resistance thermometers, also referred to as resistance temperature detectors, are sensors used to measure temperature by correlating electrical resistance with temperature. As the temperature changes, the resistance to an electrical current passing through them predictably changes likewise. They are characterized by their nominal resistance  $R_0$  at a temperature of 0 °C.

- Pt100 ( $R_0 = 100 \Omega$ )
- Pt1000 ( $R_0 = 1 \text{ k}\Omega$ )



## B

- blocks overview
  - general description, 34
  - physical description, 36

## C

- characteristics
  - environmental, 21
  - TM7ACTHA, 80
  - TM7BAI4CLA, 55
  - TM7BAI4PLA, 78
  - TM7BAI4TLA, 66
  - TM7BAI4VLA, 46
  - TM7BAM4CLA, 122
  - TM7BAM4VLA, 112
  - TM7BAO4CLA, 99
  - TM7BAO4VLA, 90

## I

- installation
  - dimensions, 31
  - requirements, 16

## L

- labeling
  - TM7 block, 30

## P

- presentation
  - TM7ACTHA, 77
  - TM7BAI4CLA, 52
  - TM7BAI4PLA, 73
  - TM7BAI4TLA, 63
  - TM7BAI4VLA, 43
  - TM7BAM4CLA, 119
  - TM7BAM4VLA, 109
  - TM7BAO4CLA, 96
  - TM7BAO4VLA, 87

## T

- TM7, 33
- TM7 analog, 33
  - TM7BAI4CLA, 51
  - TM7BAI4PLA, 72
  - TM7BAI4TLA, 62
  - TM7BAI4VLA, 42
  - TM7BAM4CLA, 118
  - TM7BAM4VLA, 108
  - TM7BAO4CLA, 95
  - TM7BAO4VLA, 86
- TM7 digital, 33
- TM7 power distribution, 33
- TM7ACTHA
  - characteristics, 80
  - presentation, 77
- TM7BAI4CLA, 33, 51
  - characteristics, 55
  - presentation, 52
  - wiring, 58
- TM7BAI4PLA, 33, 72
  - characteristics, 78
  - presentation, 73
  - wiring, 81
- TM7BAI4TLA, 33, 62
  - characteristics, 66
  - presentation, 63
  - wiring, 69

TM7BAI4VLA, 33, 42  
    characteristics, 46  
    presentation, 43  
    wiring, 49  
TM7BAM4CLA, 33, 118  
    characteristics, 122  
    presentation, 119  
    wiring, 126  
TM7BAM4VLA, 33, 108  
    characteristics, 112  
    presentation, 109  
    wiring, 116  
TM7BAO4CLA, 33, 95  
    characteristics, 99  
    presentation, 96  
    wiring, 102  
TM7BAO4VLA, 33, 86  
    characteristics, 90  
    presentation, 87  
    wiring, 93  
TM7BDI16A, 33  
TM7BDI16B, 33  
TM7BDI8B, 33  
TM7BDM16A, 33  
TM7BDM16B, 33  
TM7BDM8B, 33  
TM7BDO8TAB, 33  
TM7SPS1A, 33

## W

### wiring

    TM7BAI4CLA, 58  
    TM7BAI4PLA, 81  
    TM7BAI4TLA, 69  
    TM7BAI4VLA, 49  
    TM7BAM4CLA, 126  
    TM7BAM4VLA, 116  
    TM7BAO4CLA, 102  
    TM7BAO4VLA, 93  
wiring rules, 19