

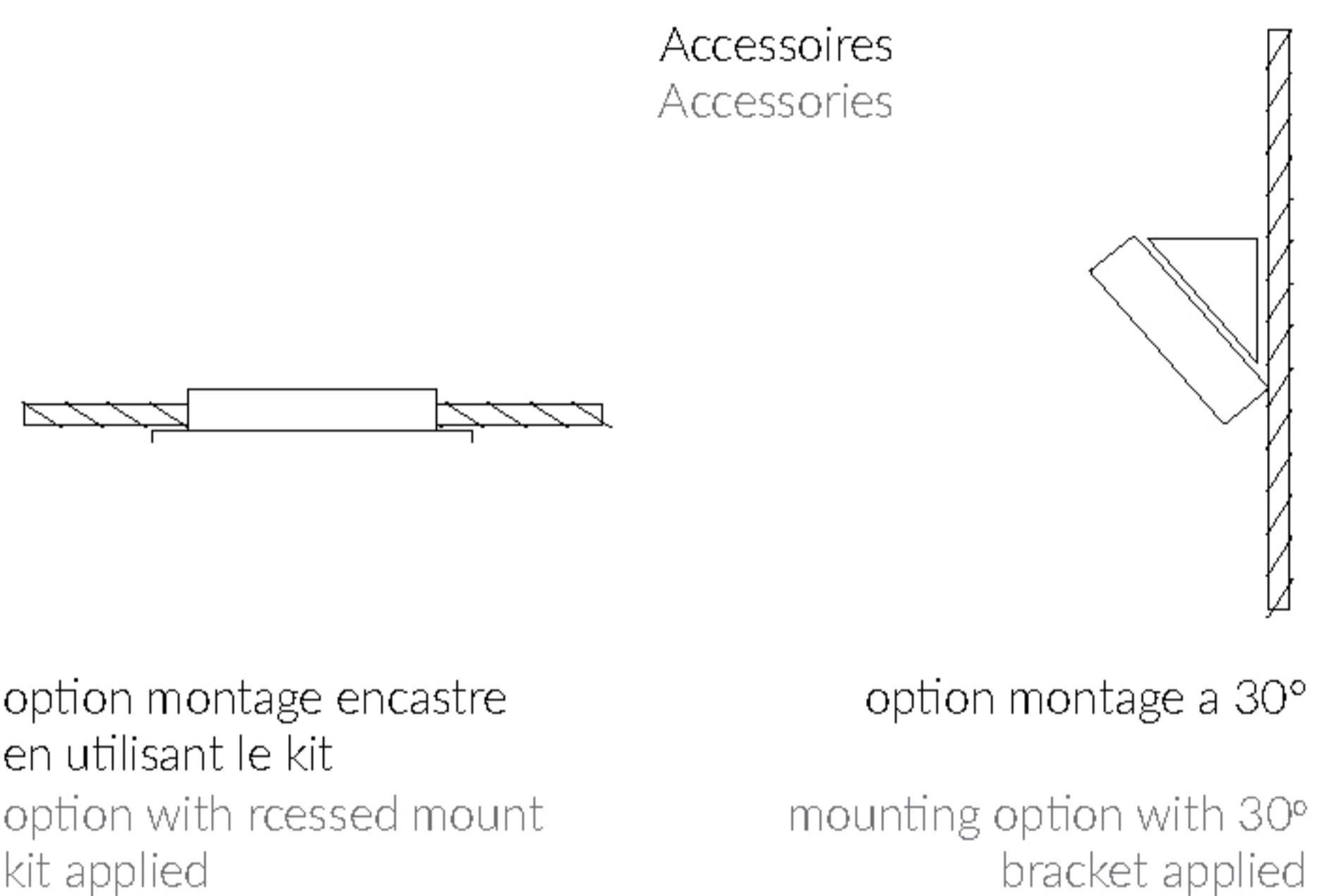

# BLOCTECH S

A1S

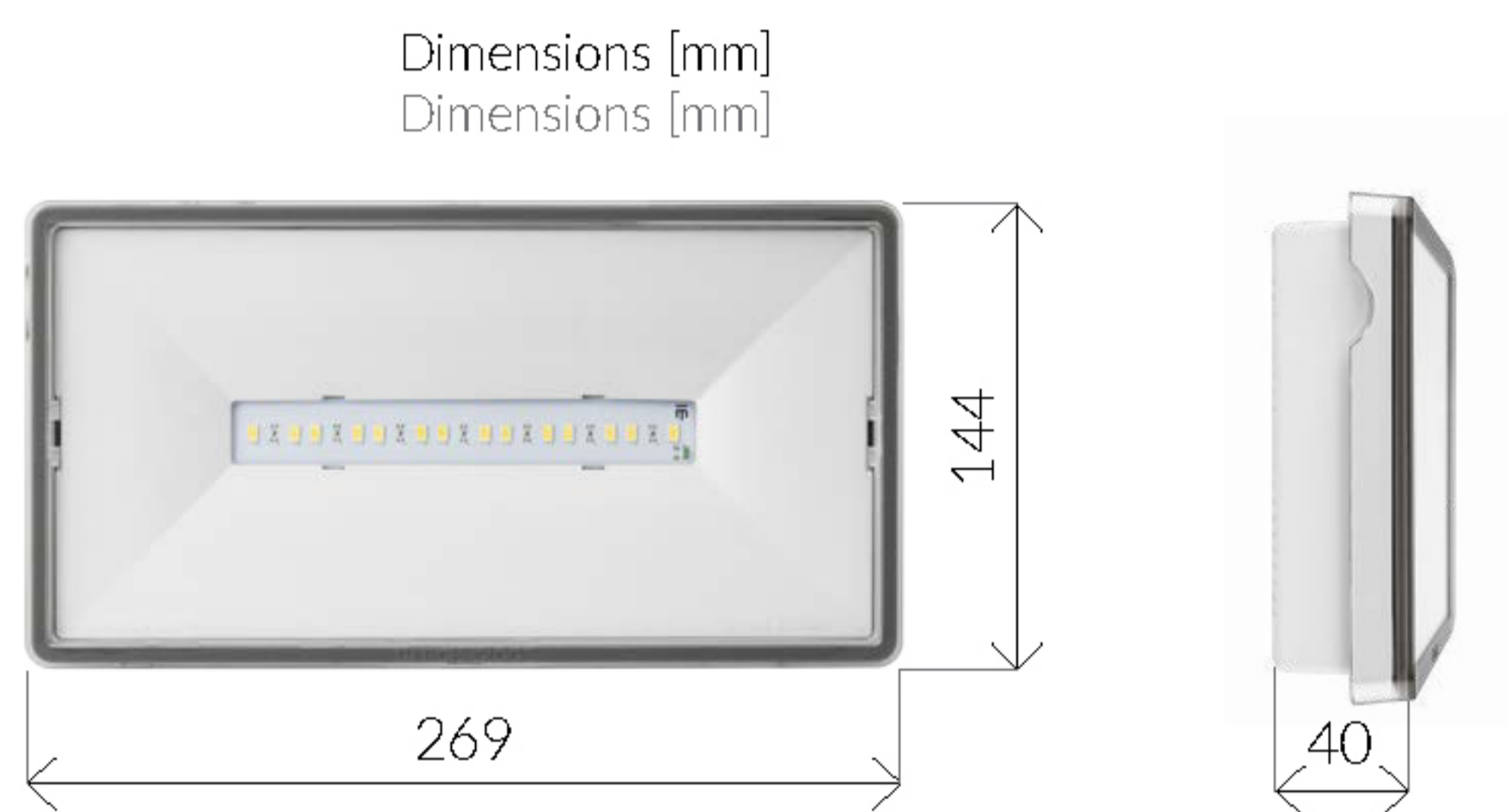

BAES Ambience - IP65 / IP44 de 390 lm  
Antipanic lighting - IP65 / IP44 of 390 lm

Model		
<b>BLOCTECH S A1S 1H 320 TC</b>	1 h	LiFePO4 3.2 V 1.5 AAh
<b>BLOCTECH S A1S 1H 320 D2</b>	1 h	LiFePO4 3.2 V 1.5 AAh

**Principales spécifications techniques**  
Technical parameters

Application Application	BAES Ambience Antipanic lighting
Source lumineuse Light source	<b>14 LED</b>
Autonomie de la batterie Battery operating time	1 h
Consommation max batterie en charge Consommation moyenne batterie chargée	<b>1.2 Wh</b> 0.3 Wh
Flux lumineux Luminous flux	390 lm
Test Testing	D2: DATA/Supervision controle TC: Performance SATI
Alimentation électrique Power supply	210÷250 V AC 50÷60Hz;
Indice de protection Protection degree	IP65 / IP44
Indice Impacts mécaniques externes Protection against mechanical impacts	IK08
Classe d'isolation Insulation class	II
Températures de fonctionnement Temperature range	t <sub>a</sub> +10 °C ÷ +40 °C
Couleurs Colour	<input type="checkbox"/> RAL 9003 <input checked="" type="checkbox"/> RAL gray or black

**Photometrie**  
Photometry

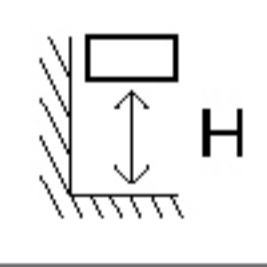
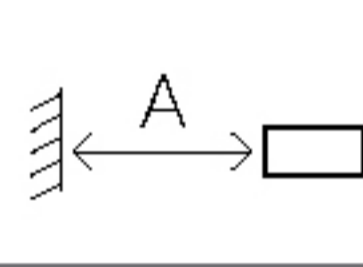
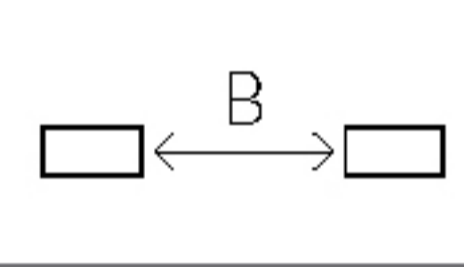
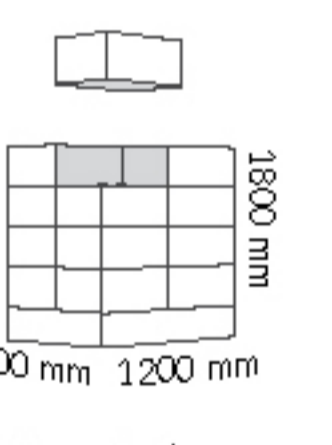
[m]	H	A	B	270,5 x 40,5 x 150
				
2,5		3,7	9,0	700 szt. / pcs
3,0		4,0	9,6	
4,0		4,3	11,4	
5,0		4,6	12,5	
6,0		4,7	13,4	
7,0		4,8	14,1	
8,0		4,8	14,5	
9,0		4,5	14,8	
10,0		4,0	15,2	

