



PNS125-169

SICK
Sensor Intelligence.



Ordering information

Type	Part no.
PNS125-169	1019434

Other models and accessories → www.sick.com/

Detailed technical data

Technical specifications

Accessory group	Deflector mirrors
Description	Horizontal deflection
Scanning range from ... to	4 m ... 15 m
Suitable for protective field height	150 mm ... 1,650 mm
Mirror material	Glass
Items supplied	Incl. mounting kit swivel mount

Classifications

ECLASS 5.0	27279207
ECLASS 5.1.4	27279207
ECLASS 6.0	27279207
ECLASS 6.2	27279207
ECLASS 7.0	27279207
ECLASS 8.0	27279207
ECLASS 8.1	27279207
ECLASS 9.0	27273605
ECLASS 10.0	27273605
ECLASS 11.0	27273605
ECLASS 12.0	27273605
ETIM 5.0	EC002467
ETIM 6.0	EC002467
ETIM 7.0	EC002467
ETIM 8.0	EC002467
UNSPSC 16.0901	39111827

Dimensional drawing (Dimensions in mm (inch))

PNS125

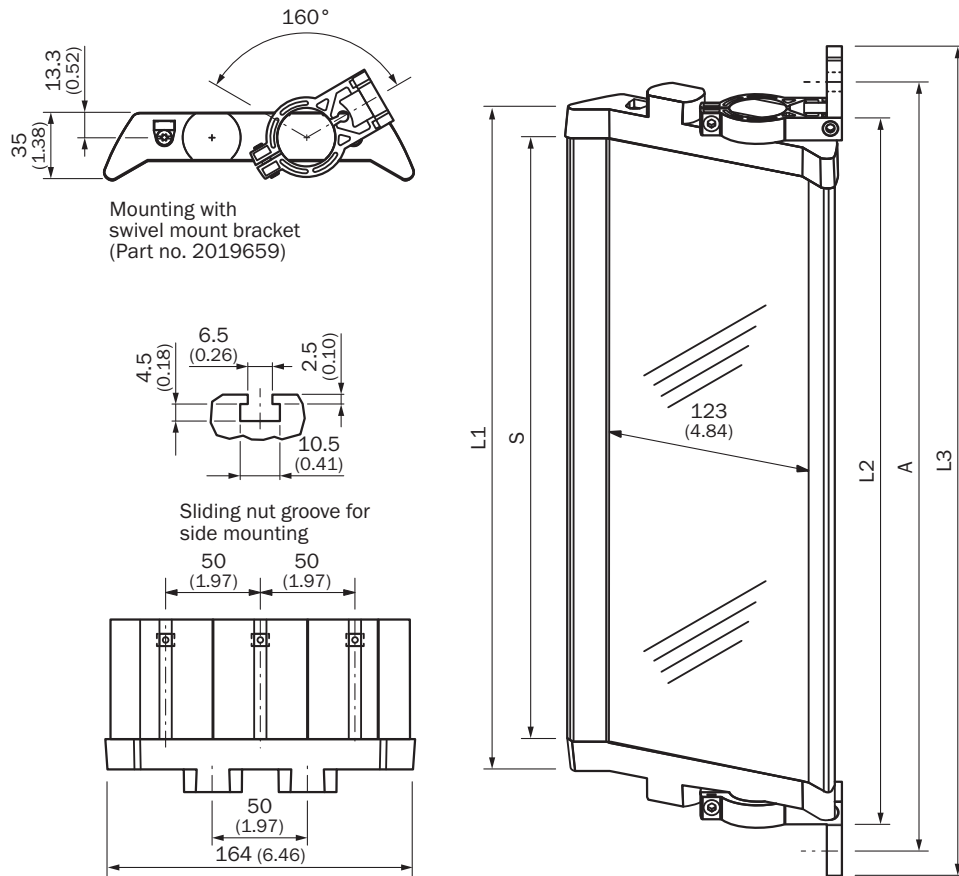

	L1	L2	L3	A
340	372	396	460	440
490	522	546	610	590
640	672	696	760	740
790	822	846	910	890
940	972	996	1,060	1,040
1,090	1,122	1,146	1,210	1,190
1,240	1,272	1,296	1,360	1,340
1,390	1,422	1,446	1,510	1,490
1,540	1,572	1,596	1,660	1,640
1,690	1,722	1,746	1,810	1,790
1,840	1,872	1,896	1,960	1,940
1,990	2,022	2,046	2,110	2,090
2,140	2,172	2,196	2,260	2,240

SICK AT A GLANCE

SICK is one of the leading manufacturers of intelligent sensors and sensor solutions for industrial applications. A unique range of products and services creates the perfect basis for controlling processes securely and efficiently, protecting individuals from accidents and preventing damage to the environment.

We have extensive experience in a wide range of industries and understand their processes and requirements. With intelligent sensors, we can deliver exactly what our customers need. In application centers in Europe, Asia and North America, system solutions are tested and optimized in accordance with customer specifications. All this makes us a reliable supplier and development partner.

Comprehensive services complete our offering: SICK LifeTime Services provide support throughout the machine life cycle and ensure safety and productivity.

For us, that is “Sensor Intelligence.”

WORLDWIDE PRESENCE:

Contacts and other locations –www.sick.com