

Chemin de câbles fil
(Mesh tray)

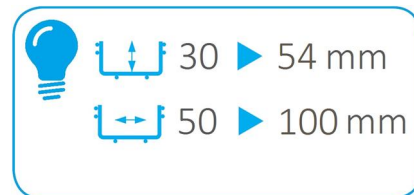
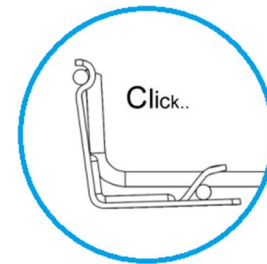
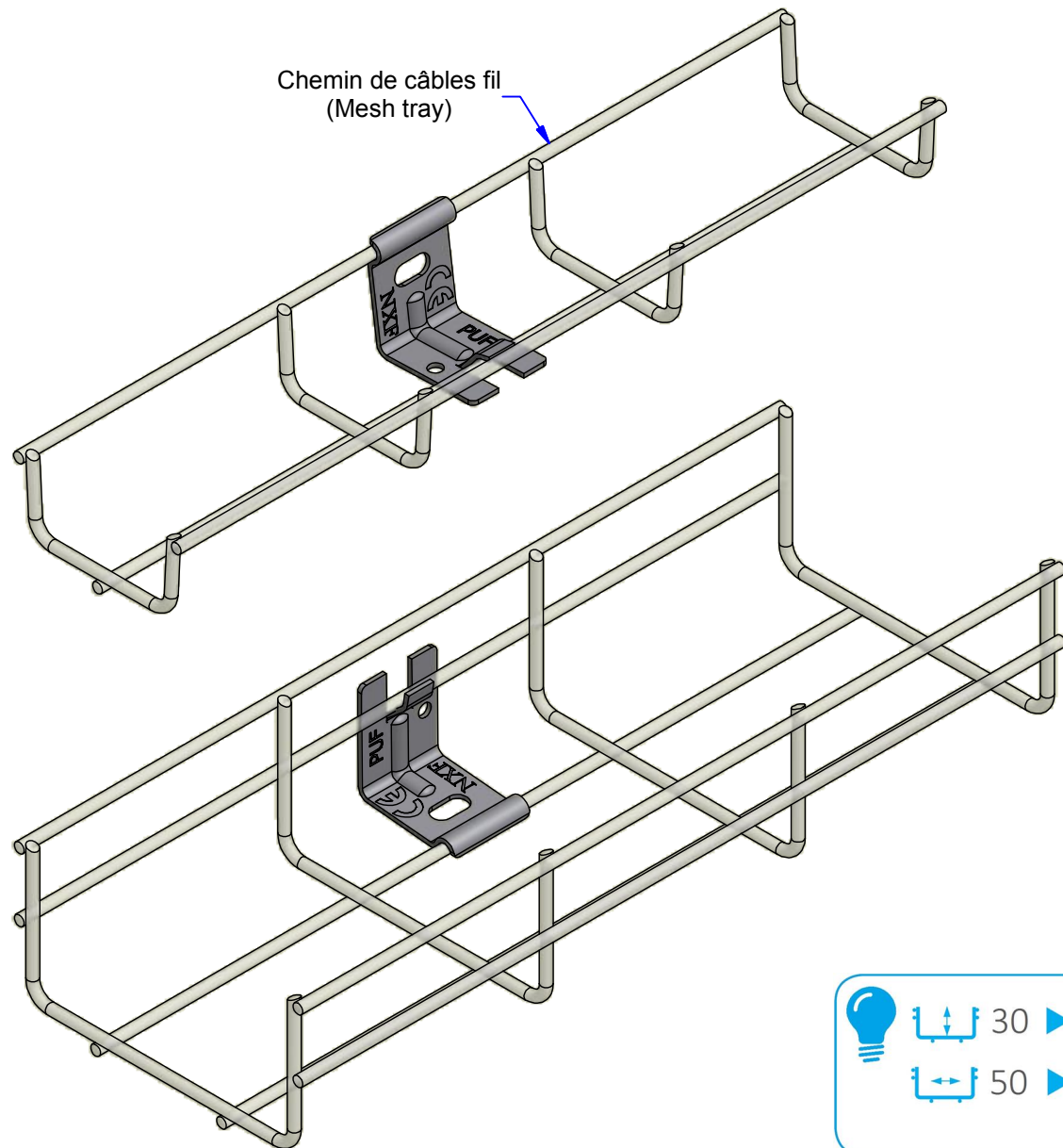

www.niedaxfrance.fr

Description	Code	Masse/Weight Kg/p	Ep./Th. mm	daN	daN
PUF I2	554036	0,026	1,50	20	20

SS304L : Stainless steel according to NF EN 10088-2 (304L).
I2 : Tôle d'acier inoxydable suivant NF EN 10088-2 (304L).

PATTE MULTI PUF I2
 PUF BRACKET SS304L



ASSISTANCE TECHNIQUE
 +33 (0)1 55 95 92 17
 pole.technique@niedax.fr

FT02556

NIEDAX
 France

