

1SNA235830R0000 ✓ ACTIVE

ENTRELEC | ENTRELEC HTP600

TE Internal #: 1SNA235830R0000

Terminal Block & Strip Marking Accessories, Label, Blank Mark Details, White, 14 – 122 °F [-10 – 50 °C], UL 94V-0, ENTRELEC HTP600

[View on TE.com >](#)



Connectors > Terminal Blocks & Strips > Terminal Block & Strip Accessories > Terminal Block & Strip Marking Accessories

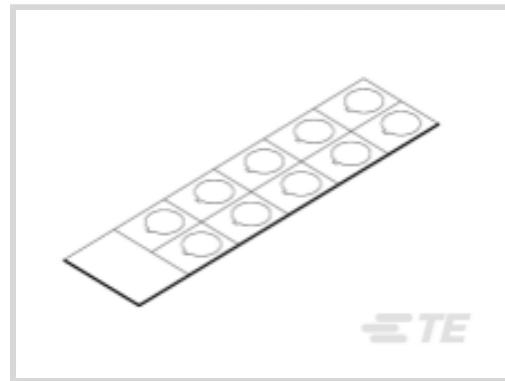

Marking Product Type: **Label**

Pre-Printed Mark Details: **Blank**

Primary Product Color: **White**

Operating Temperature Range: **-10 – 50 °C [14 – 122 °F]**

UL Flammability Rating: **UL 94V-0**

Features

Product Type Features

Marking Product Type	Label
----------------------	-------

Configuration Features

Number of Cards per Package	44
Pre-Printed Mark Details	Blank

Body Features

Primary Product Color	White
-----------------------	-------

Usage Conditions

Operating Temperature Range	-10 – 50 °C[14 – 122 °F]
-----------------------------	--------------------------

Industry Standards

UL Flammability Rating	UL 94V-0
------------------------	----------

Product Compliance

[For compliance documentation, visit the product page on TE.com>](#)

EU RoHS Directive 2011/65/EU	Compliant
EU ELV Directive 2000/53/EC	Compliant
China RoHS 2 Directive MIIT Order No 32, 2016	No Restricted Materials Above Threshold
EU REACH Regulation (EC) No. 1907/2006	



Current ECHA Candidate List: JUNE 2022 (224)
 Candidate List Declared Against: JUNE 2022 (224)
 Does not contain REACH SVHC

Halogen Content	Not Yet Reviewed for halogen content
Solder Process Capability	Not applicable for solder process capability

Product Compliance Disclaimer

This information is provided based on reasonable inquiry of our suppliers and represents our current actual knowledge based on the information they provided. This information is subject to change. The part numbers that TE has identified as EU RoHS compliant have a maximum concentration of 0.1% by weight in homogenous materials for lead, hexavalent chromium, mercury, PBB, PBDE, DBP, BBP, DEHP, DIBP, and 0.01% for cadmium, or qualify for an exemption to these limits as defined in the Annexes of Directive 2011/65/EU (RoHS2). Finished electrical and electronic equipment products will be CE marked as required by Directive 2011/65/EU. Components may not be CE marked. Additionally, the part numbers that TE has identified as EU ELV compliant have a maximum concentration of 0.1% by weight in homogenous materials for lead, hexavalent chromium, and mercury, and 0.01% for cadmium, or qualify for an exemption to these limits as defined in the Annexes of Directive 2000/53/EC (ELV). Regarding the REACH Regulation, the information TE provides on SVHC in articles for this part number is based on the latest European Chemicals Agency (ECHA) 'Guidance on requirements for substances in articles' posted at this URL: <https://echa.europa.eu/guidance-documents/guidance-on-reach>

Compatible Parts



Also in the Series | ENTRELEC HTP600

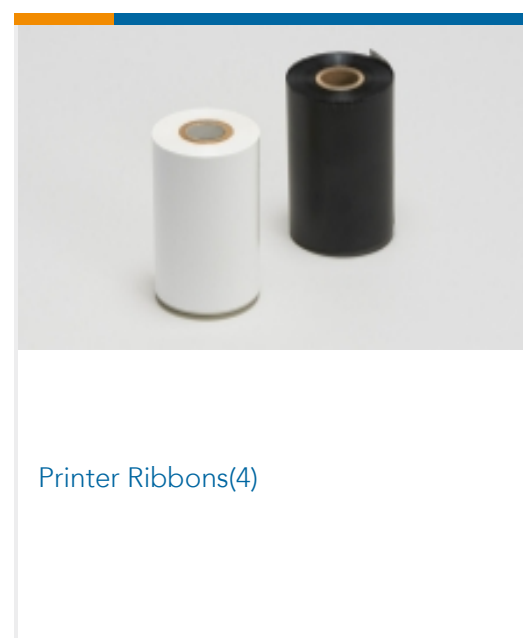
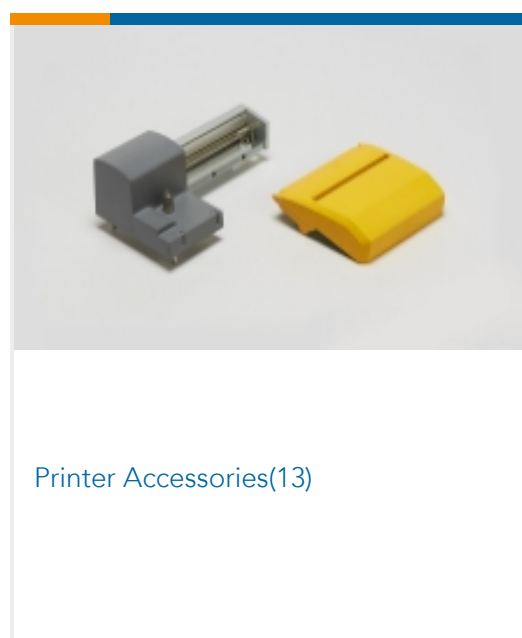

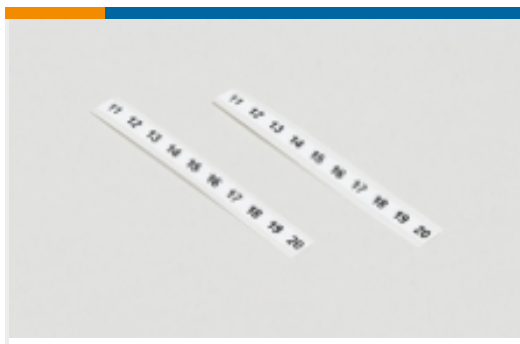

Terminal Block & Strip Marking Accessories(115)

Customers Also Bought



TE Part #1SNA235094R1500
WMTT18



TE Part #1SNA235533R0000
PM187



TE Part #1SNA235534R0000
PM1810



TE Part #1SNA235545R0000
PM307



TE Part #1SNA235590R0000
WMTT30



TE Part #1SNA235714R2600
HTP500-CLEAN

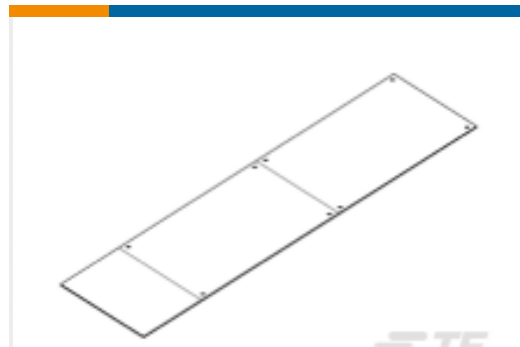

TE Part #1SNA235884R0000
PPT60100



TE Part #1SNA235887R0000
PLHA43015

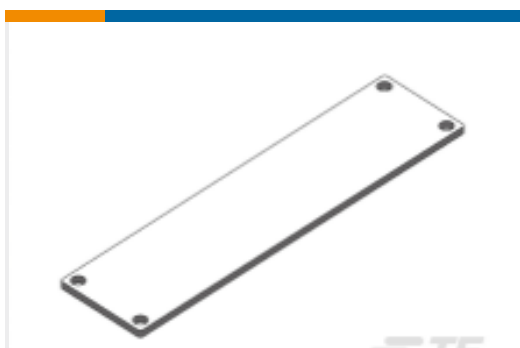

TE Part #1SNA235115R1600
PPT12030

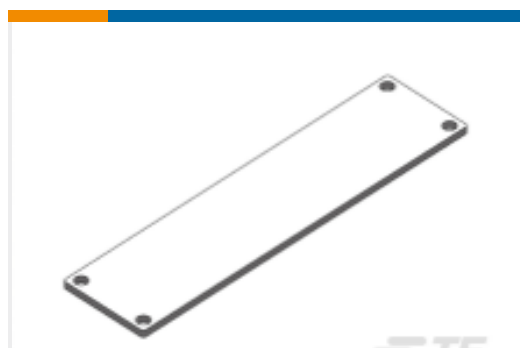

TE Part #1SNA235116R1700
PPT18050

Documents

Product Drawings

[PTS22.5-3040](#)

English

Datasheets & Catalog Pages

[Catalogue - HTP600 Thermal Transfer Printer and Markers](#)

English

[Datasheet - Htp600](#)

French

1SNA235830R0000

Terminal Block & Strip Marking Accessories, Label, Blank Mark Details, White, 14 –
122 °F [-10 – 50 °C], UL 94V-0, ENTRELEC HTP600



[Datasheet - Htp600 Thermal-Transfer-Printer-Marker](#)

English

[Datasheet - Htp600 Thermal-Transfer-Printer-Marker](#)

French