



# IMB12-08NPSVUDKS22

IMB

INDUCTIVE PROXIMITY SENSORS

**SICK**  
Sensor Intelligence.



Illustration may differ



### Ordering information

Type	Part no.
IMB12-08NPSVUDKS22	1137042

**Included in delivery:** BEF-MU-M12N (1)

Other models and accessories → [www.sick.com/IMB](http://www.sick.com/IMB)

### Detailed technical data

#### Features

<b>Housing</b>	Cylindrical thread design
<b>Housing</b>	Short-body
<b>Thread size</b>	M12 x 1
<b>Diameter</b>	Ø 12 mm
<b>Sensing range <math>S_n</math></b>	8 mm
<b>Safe sensing range <math>S_a</math></b>	6.48 mm
<b>Installation type</b>	Non-flush
<b>Switching frequency</b>	2,000 Hz
<b>Connection type</b>	Cable, 3-wire, 2.5 m
<b>Switching output</b>	PNP
<b>Output function</b>	NO
<b>Electrical wiring</b>	DC 3-wire
<b>Enclosure rating</b>	IP68 <sup>1)</sup> IP69K <sup>2)</sup>
<b>Special features</b>	Resistant against coolant lubricants, Visual adjustment indicator, IO-Link, Temperature resistance
<b>Special applications</b>	Zones with coolants and lubricants, Mobile machines, Difficult application conditions
<b>Items supplied</b>	Mounting nut, V2A stainless steel, with locking teeth (2x)

<sup>1)</sup> According to EN 60529.

<sup>2)</sup> According to ISO 20653:2013-03.

## Mechanics/electronics

<b>Supply voltage</b>	10 V DC ... 30 V DC
<b>Ripple</b>	≤ 10 %
<b>Voltage drop</b>	≤ 2 V <sup>1)</sup>
<b>Hysteresis</b>	3 % ... 20 %
<b>Reproducibility</b>	≤ 2 % <sup>2) 3)</sup>
<b>Temperature drift (of S<sub>r</sub>)</b>	± 10 %
<b>EMC</b>	According to EN 60947-5-2
<b>Continuous current I<sub>a</sub></b>	≤ 200 mA
<b>No load current</b>	≤ 10 mA
<b>Cable material</b>	PUR
<b>Conductor size</b>	0.34 mm <sup>2</sup>
<b>Cable diameter</b>	Ø 4.5 mm
<b>Short-circuit protection</b>	✓
<b>Reverse polarity protection</b>	✓
<b>Power-up pulse protection</b>	✓
<b>Shock and vibration resistance</b>	100 g / 2 ms / 500 cycles; 150 g / 1 Mio cycles; 10 Hz ... 55 Hz / 1 mm; 55 Hz ... 500 Hz / 60 g
<b>Ambient operating temperature</b>	-40 °C ... +100 °C
<b>Housing material</b>	Stainless steel V2A, DIN 1.4305 / AISI 303
<b>Sensing face material</b>	Plastic, LCP
<b>Housing length</b>	34 mm
<b>Thread length</b>	25 mm
<b>Tightening torque, max.</b>	Typ. 20 Nm <sup>4)</sup> Typ. 32 Nm <sup>5)</sup>
<b>Protection class</b>	III
<b>UL File No.</b>	E181493

<sup>1)</sup> At I<sub>a</sub> max.

<sup>2)</sup> Supply voltage U<sub>B</sub> and constant ambient temperature T<sub>a</sub>.

<sup>3)</sup> Of S<sub>r</sub>.

<sup>4)</sup> When using the non-toothed side of the nut.

<sup>5)</sup> Valid if toothed side of nut is used.

## Safety-related parameters

<b>MTTF<sub>D</sub></b>	1,971 years
<b>DC<sub>avg</sub></b>	0 %

## Communication interface

<b>Communication interface</b>	IO-Link V1.0
<b>Communication Interface detail</b>	COM2 (38,4 kBaud)
<b>Process data length</b>	1 Byte
<b>Process data structure</b>	Bit 0 = S <sub>r</sub> reached Bit 1 = S <sub>a</sub> reached

### Reduction factors

<b>Note</b>	The values are reference values which may vary
<b>St37 steel (Fe)</b>	1
<b>Stainless steel (V2A, 304)</b>	Approx. 0.67
<b>Aluminum (Al)</b>	Approx. 0.42
<b>Copper (Cu)</b>	Approx. 0.35
<b>Brass (Br)</b>	Approx. 0.42

### Installation note

<b>Remark</b>	Associated graphic see "Installation"
<b>A</b>	12 mm
<b>B</b>	24 mm
<b>C</b>	12 mm
<b>D</b>	24 mm
<b>E</b>	16 mm
<b>F</b>	64 mm

### Classifications

<b>ECLASS 5.0</b>	27270101
<b>ECLASS 5.1.4</b>	27270101
<b>ECLASS 6.0</b>	27270101
<b>ECLASS 6.2</b>	27270101
<b>ECLASS 7.0</b>	27270101
<b>ECLASS 8.0</b>	27270101
<b>ECLASS 8.1</b>	27270101
<b>ECLASS 9.0</b>	27270101
<b>ECLASS 10.0</b>	27270101
<b>ECLASS 11.0</b>	27270101
<b>ECLASS 12.0</b>	27274001
<b>ETIM 5.0</b>	EC002714
<b>ETIM 6.0</b>	EC002714
<b>ETIM 7.0</b>	EC002714
<b>ETIM 8.0</b>	EC002714
<b>UNSPSC 16.0901</b>	39122230

### Adjustments

#### Installation aid

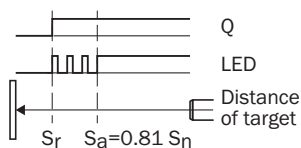

### Installation note

Non-flush installation



### Connection diagram

Cd-452

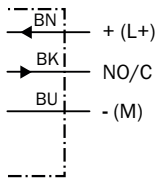

### Response diagram

Response diagram

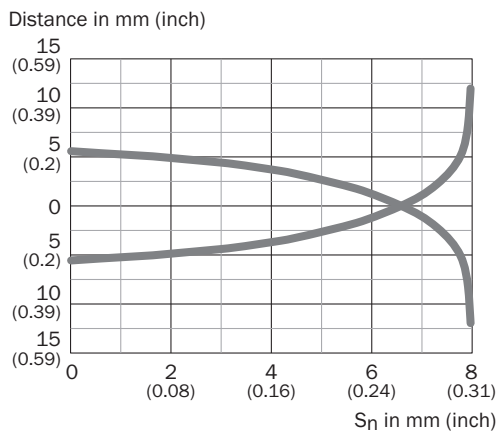

### Dimensional drawing (Dimensions in mm (inch))



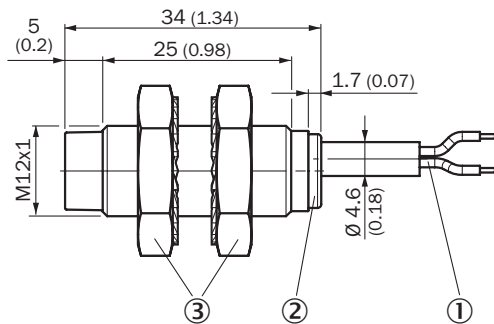



IMB12 Short-body housing, cable, non-flush



- ① Connection
- ② Display LED
- ③ Fastening nuts (2 x); width across 17, stainless steel V2A

### Recommended accessories

Other models and accessories → [www.sick.com/IMB](http://www.sick.com/IMB)

	Brief description	Type	Part no.
<b>Universal bar clamp systems</b>			
	Plate N05N for universal clamp bracket, M12, Stainless steel 1.4571 (sheet), Stainless steel 1.4408 (clamp), Universal clamp (5322627), mounting hardware	BEF-KHS-N05N	2051621
<b>Mounting brackets and plates</b>			
	Mounting plate for M12 sensors, stainless steel, without mounting hardware	BEF-WG-M12N	5320950
	Mounting bracket for M12 housing, stainless steel, without mounting hardware	BEF-WN-M12N	5320949
<b>Plug connectors and cables</b>			
	<ul style="list-style-type: none"> <li>• <b>Connection type head A:</b> Female connector, M12, 4-pin, straight</li> <li>• <b>Description:</b> Unshielded</li> <li>• <b>Connection systems:</b> Screw-type terminals</li> <li>• <b>Permitted cross-section:</b> ≤ 0.75 mm<sup>2</sup></li> <li>• <b>Application:</b> Hygienic and washdown zones</li> </ul>	DOS-1204-GN	6028357
	<ul style="list-style-type: none"> <li>• <b>Connection type head A:</b> Female connector, M12, 4-pin, angled</li> <li>• <b>Description:</b> Unshielded</li> <li>• <b>Connection systems:</b> Screw-type terminals</li> <li>• <b>Permitted cross-section:</b> ≤ 0.75 mm<sup>2</sup></li> <li>• <b>Application:</b> Hygienic and washdown zones</li> </ul>	DOS-1204-WN	6028358
	<ul style="list-style-type: none"> <li>• <b>Connection type head A:</b> Male connector, M12, 4-pin, straight</li> <li>• <b>Description:</b> Unshielded</li> <li>• <b>Connection systems:</b> Screw-type terminals</li> <li>• <b>Permitted cross-section:</b> ≤ 0.75 mm<sup>2</sup></li> <li>• <b>Application:</b> Hygienic and washdown zones</li> </ul>	STE-1204-GN	6028359

	Brief description	Type	Part no.
	<ul style="list-style-type: none"><li>• <b>Connection type head A:</b> Male connector, M12, 4-pin, straight</li><li>• <b>Description:</b> Unshielded</li><li>• <b>Connection systems:</b> Screw-type terminals</li><li>• <b>Permitted cross-section:</b> <math>\leq 0.75 \text{ mm}^2</math></li><li>• <b>Note:</b> For 2 cable connections</li><li>• <b>Application:</b> Hygienic and washdown zones</li></ul>	STE-1204-TN	6028360

## SICK AT A GLANCE

SICK is one of the leading manufacturers of intelligent sensors and sensor solutions for industrial applications. A unique range of products and services creates the perfect basis for controlling processes securely and efficiently, protecting individuals from accidents and preventing damage to the environment.

We have extensive experience in a wide range of industries and understand their processes and requirements. With intelligent sensors, we can deliver exactly what our customers need. In application centers in Europe, Asia and North America, system solutions are tested and optimized in accordance with customer specifications. All this makes us a reliable supplier and development partner.

Comprehensive services complete our offering: SICK LifeTime Services provide support throughout the machine life cycle and ensure safety and productivity.

For us, that is “Sensor Intelligence.”

## WORLDWIDE PRESENCE:

Contacts and other locations –[www.sick.com](http://www.sick.com)