

STADIUMPRO | 2

SPATIUMPRO | 2

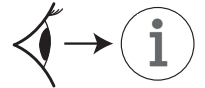

GWP30023/GWP30024 - DALI
GWP30025/GWP30026 - 0-10V



IP66

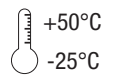

	⊗		V	I	Uout
STADIUMPRO 2	DALI		220-240V 50/60Hz	Max 1,2A	Max 600V ⁻⁻⁻
	0-10V				
SPATIUMPRO 2	DALI		220-240V 50/60Hz	Max 0,95A	Max 600V ⁻⁻⁻
	0-10V				

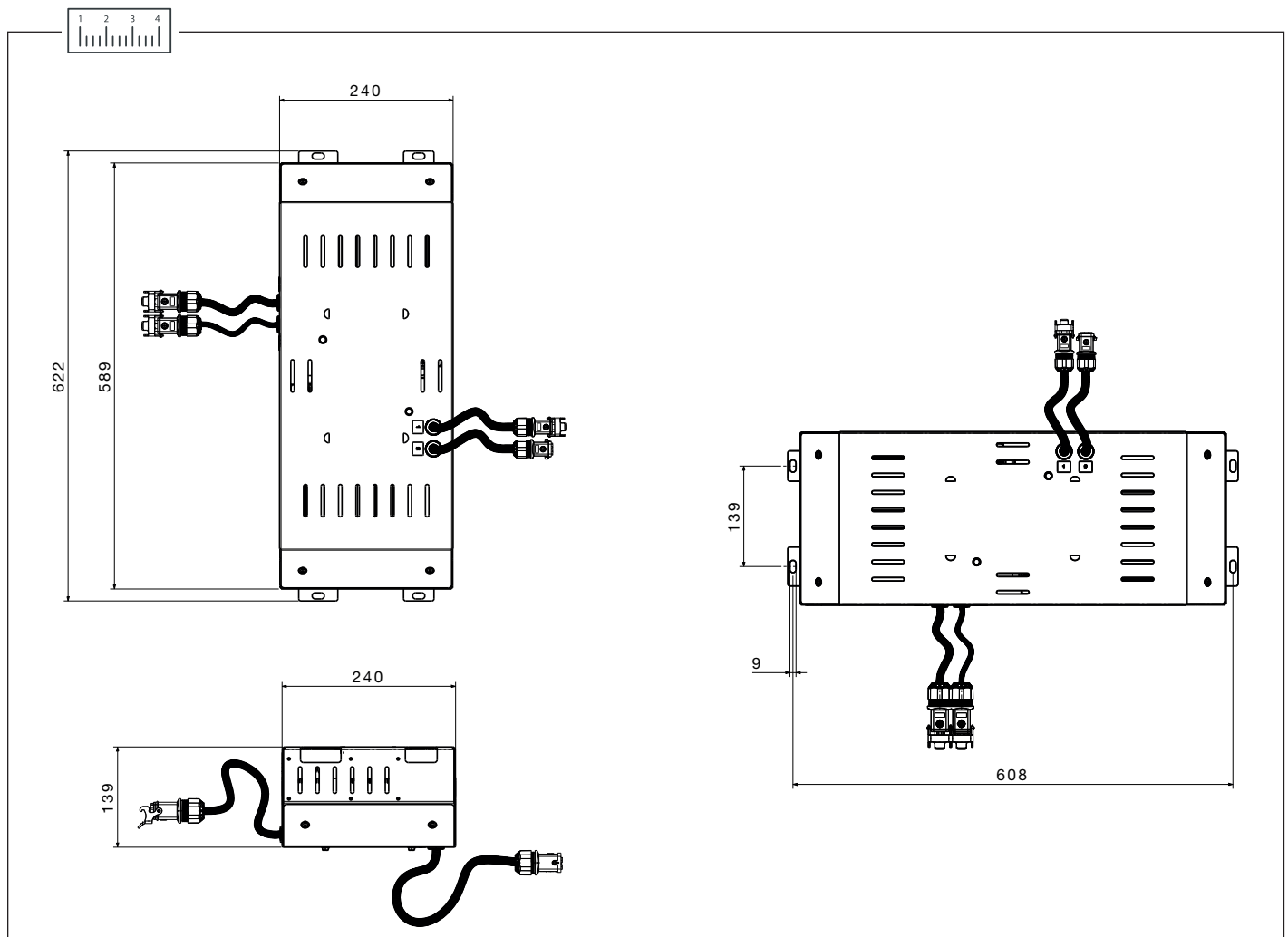

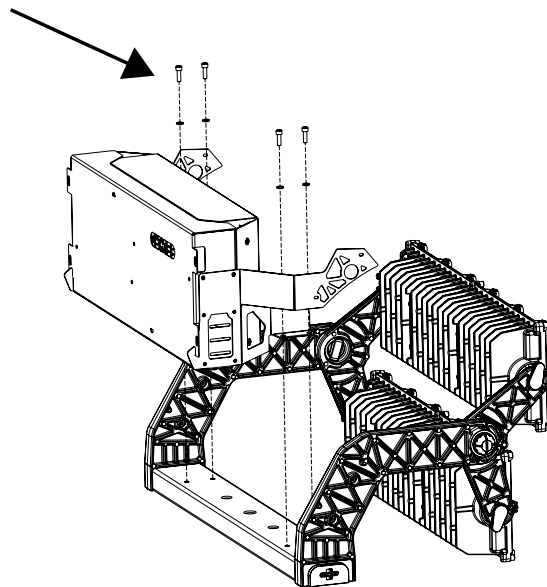
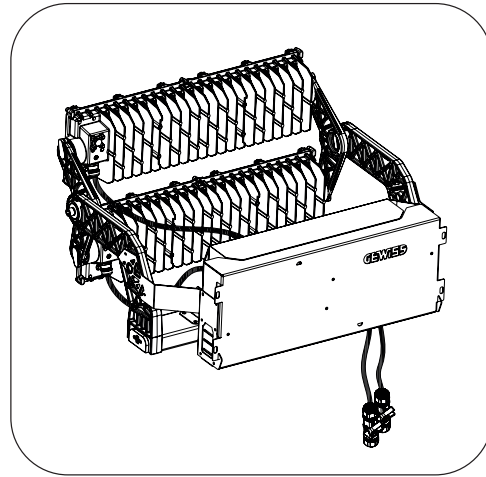
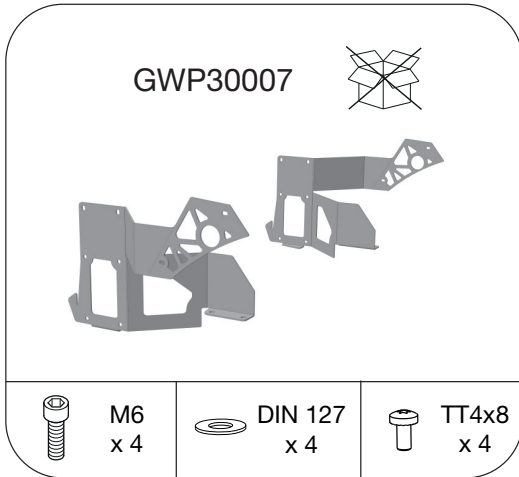

Inrush Current (peak)		
V_{in}	I_{peak}	Half Value time
220 Vac	28,6	2,4 ms

# GWP3002x for MCB - 220V				
	10A	16A	20A	25A
Type B:	1	1	2	2
Type C:	1	1	2	2
Type D:	1	2	2	3

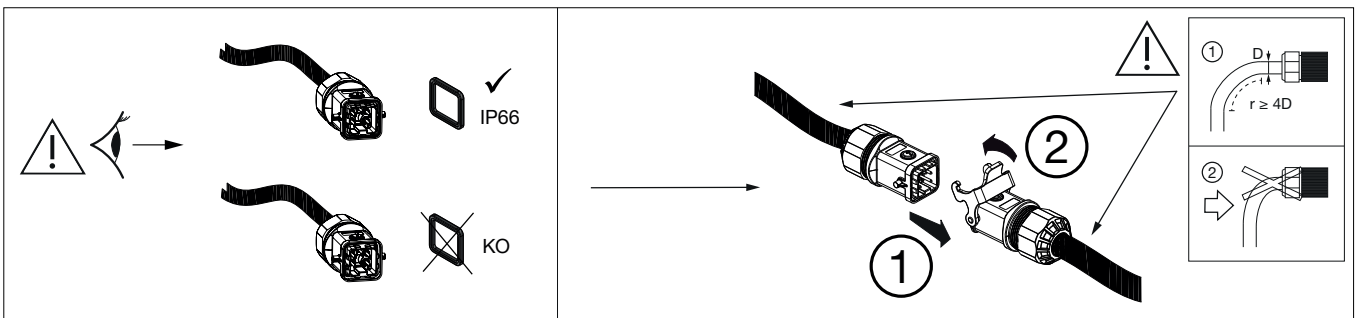
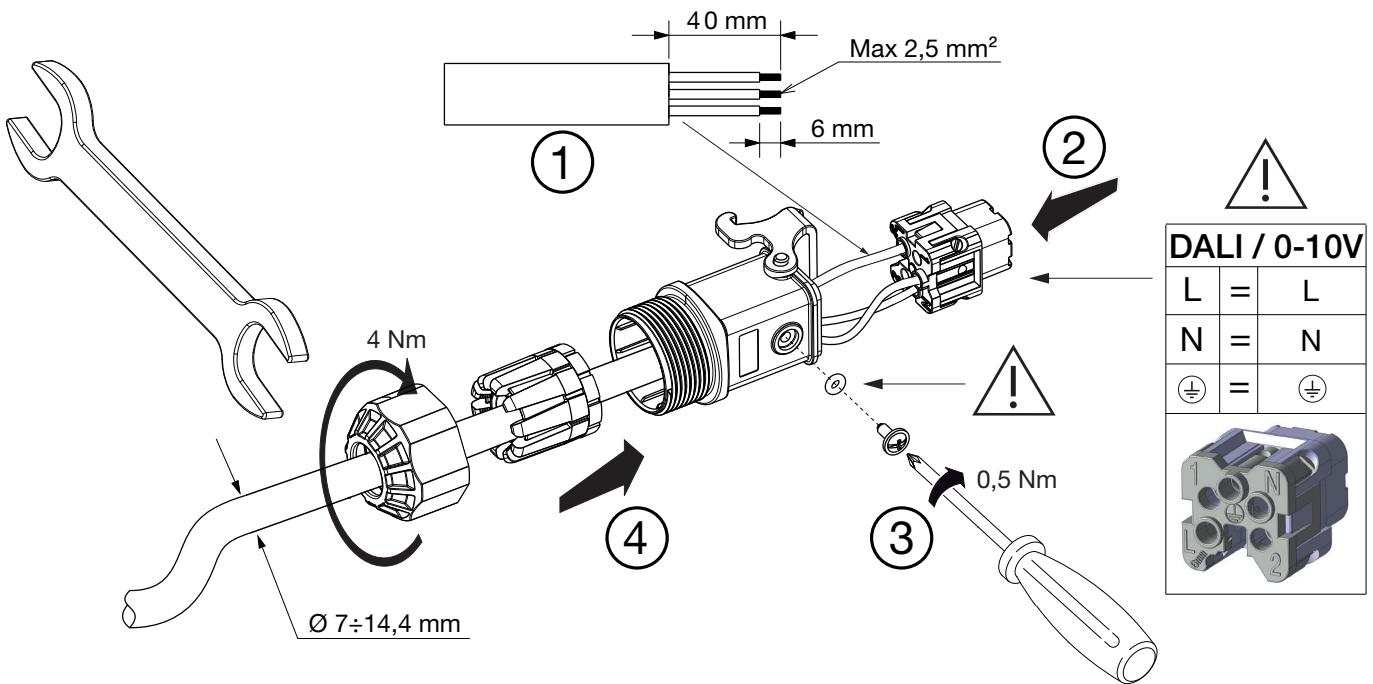
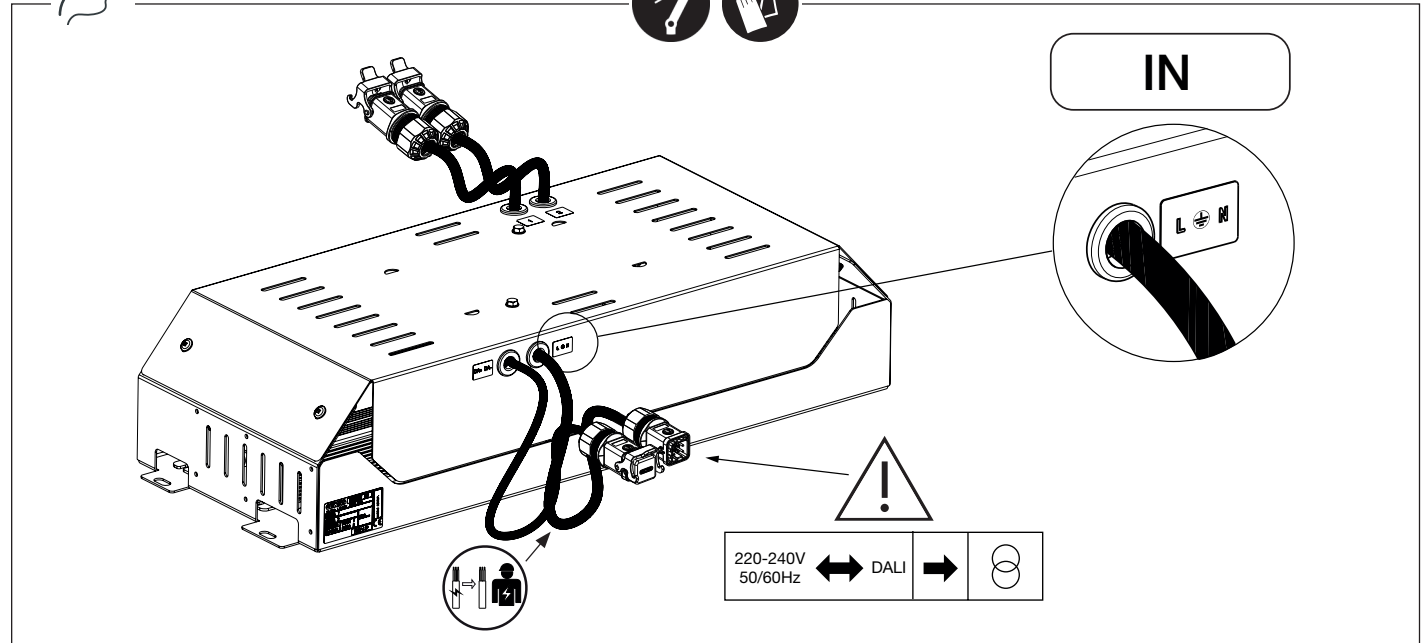



DALI

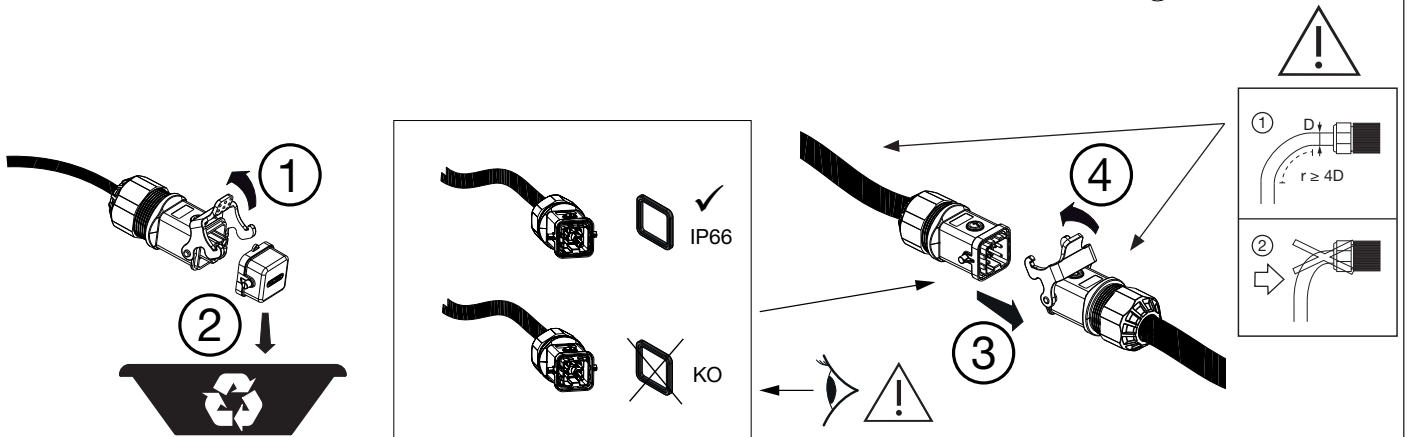
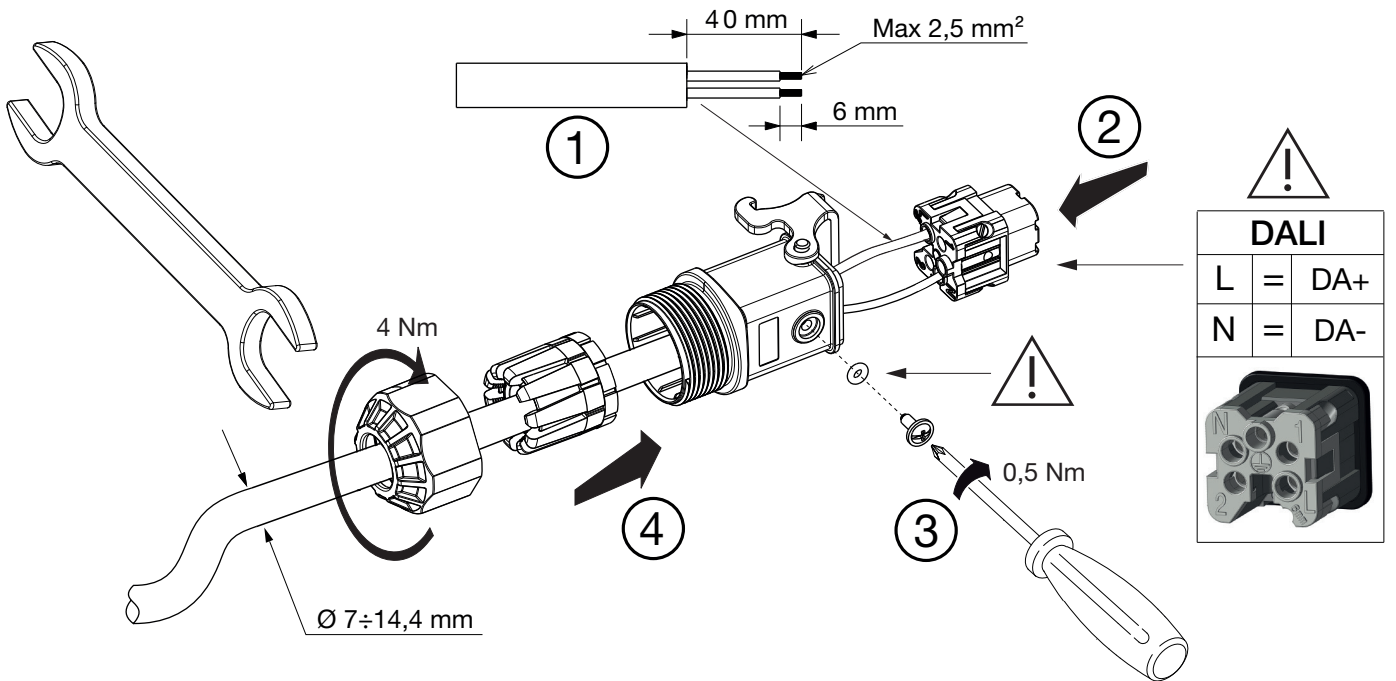
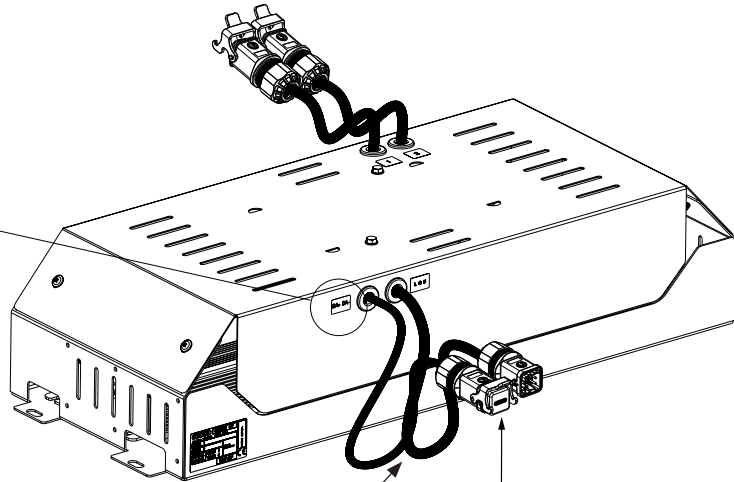
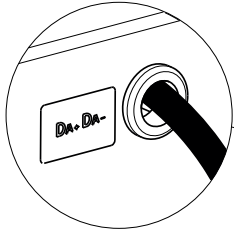



0-10V

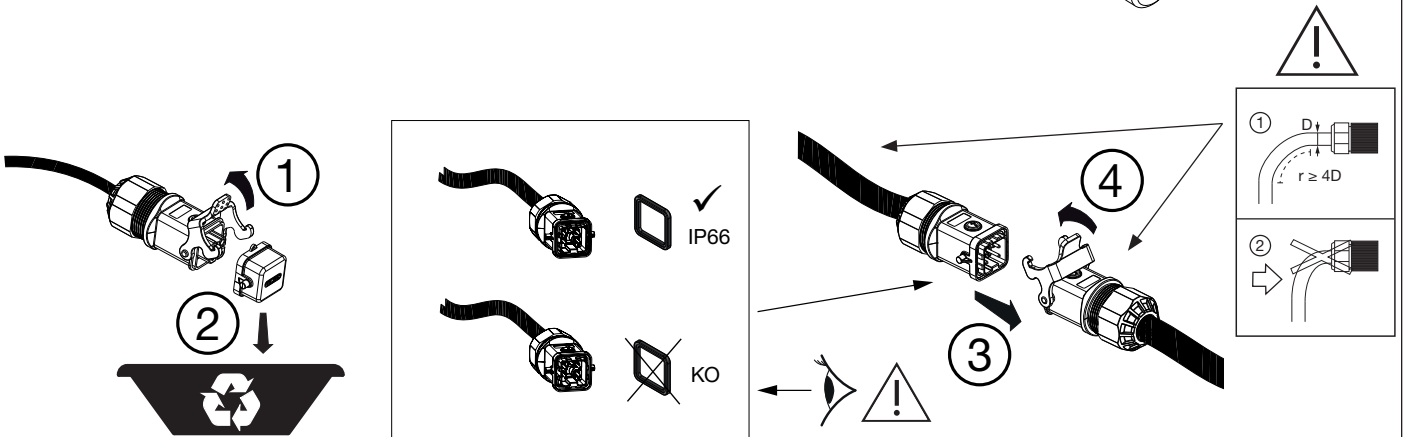
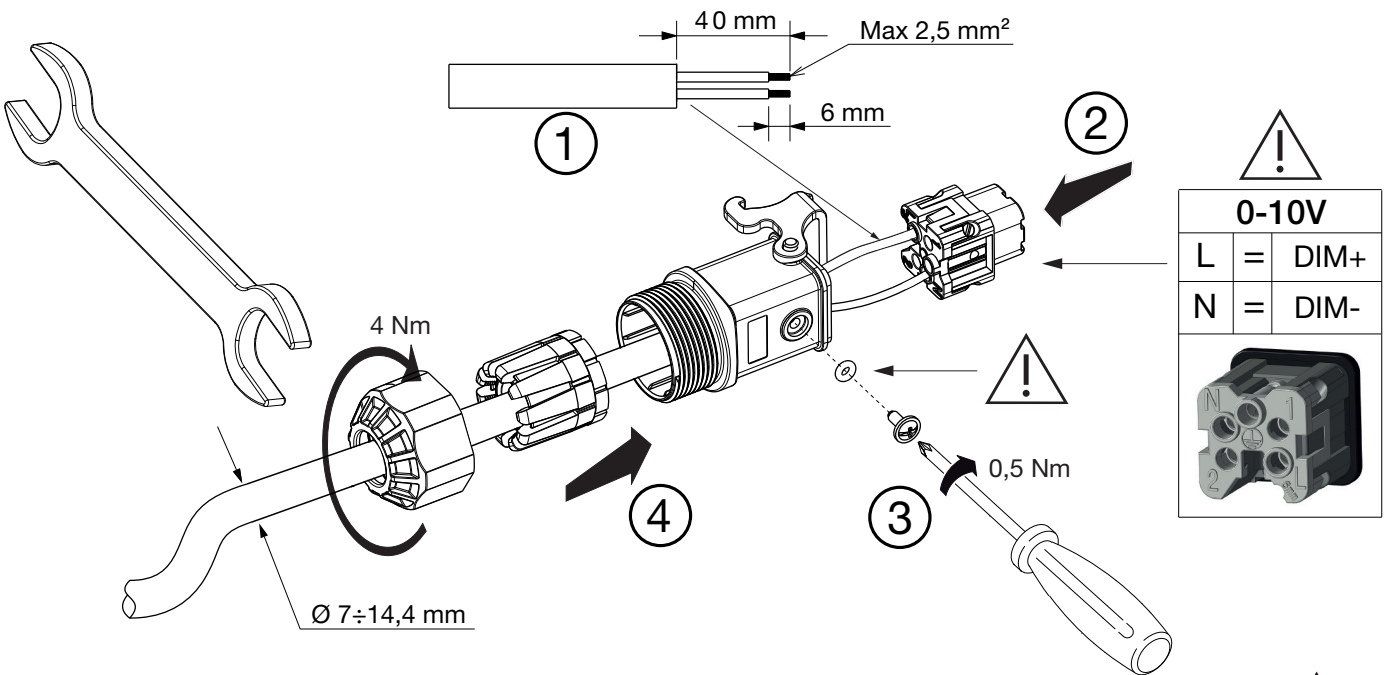
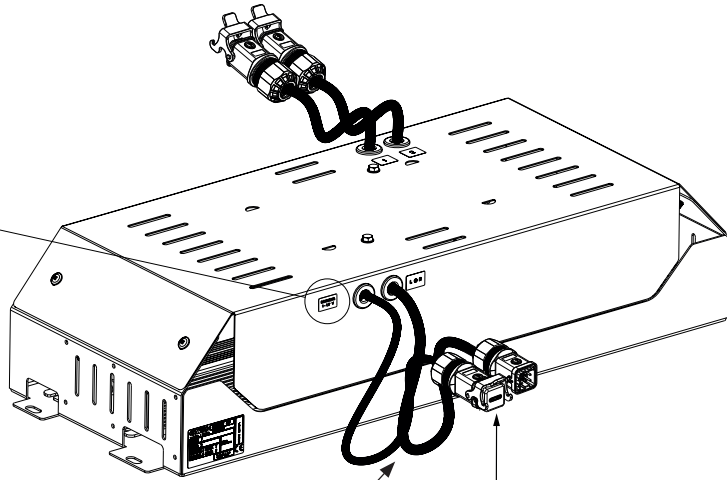



😊 **OK**

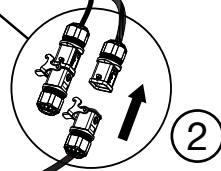
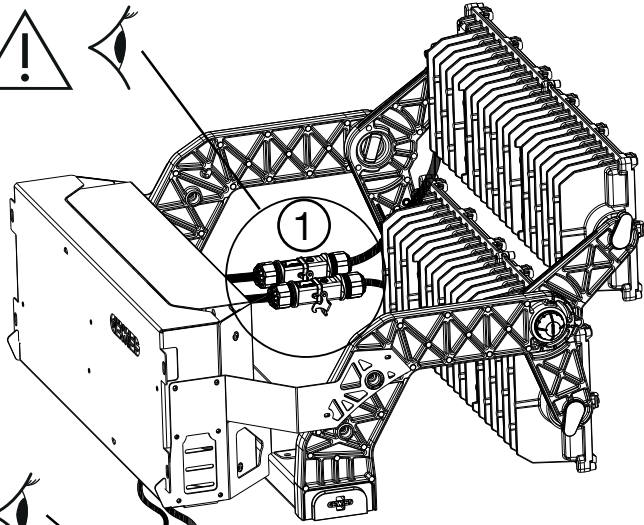

☹️ **KO**

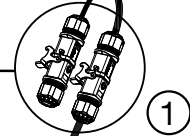
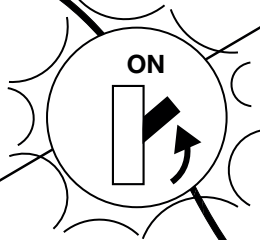
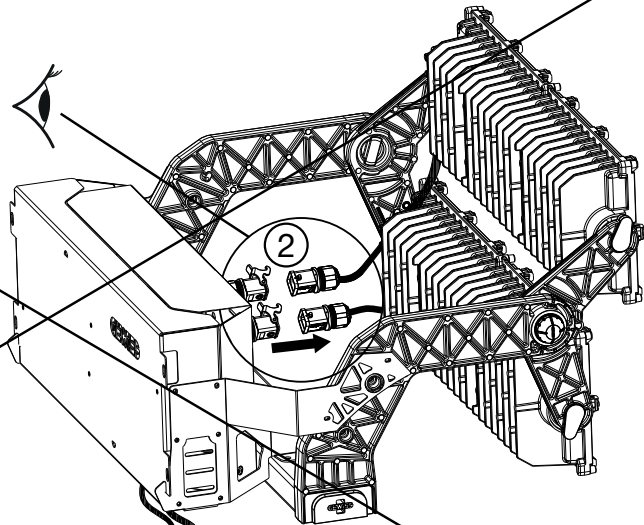
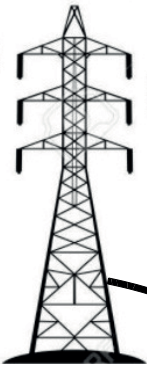

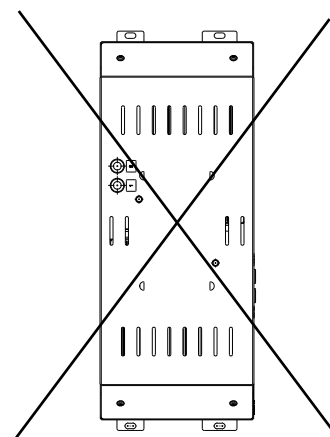
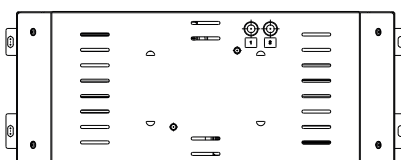
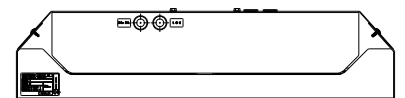
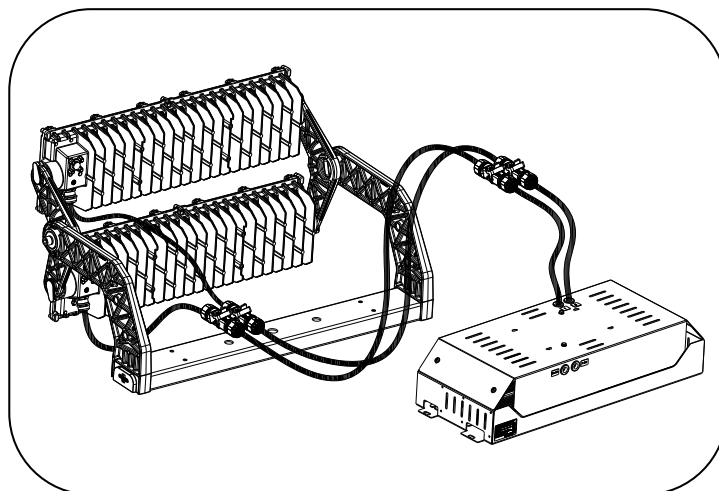



B

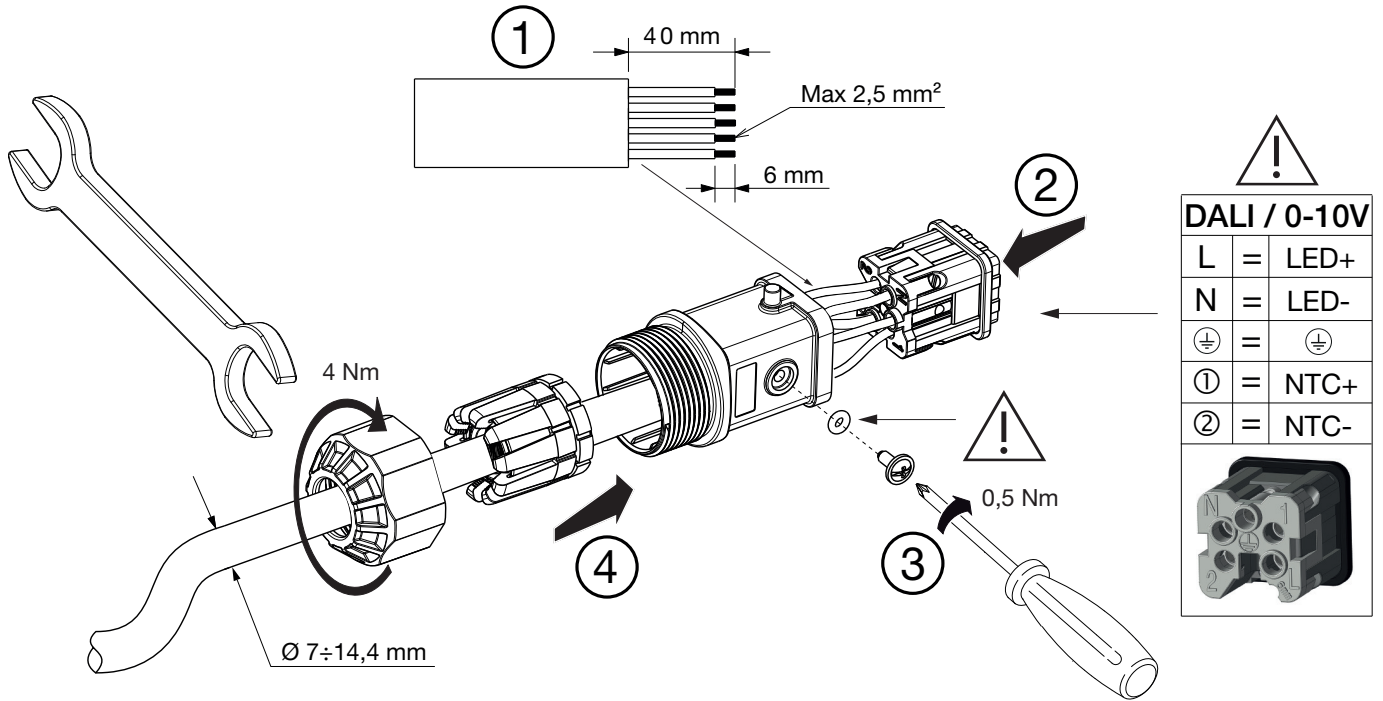

!	
DALI / 0-10V	
L	= LED+
N	= LED-
⊕	= ⊕
①	= NTC+
②	= NTC-

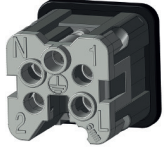
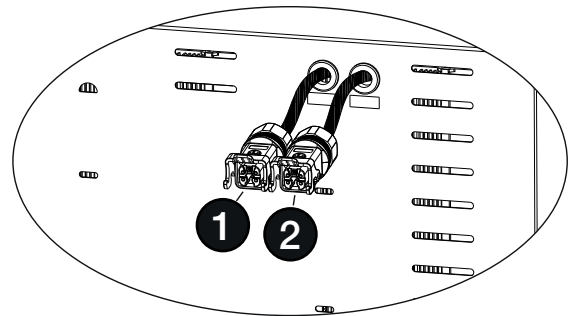
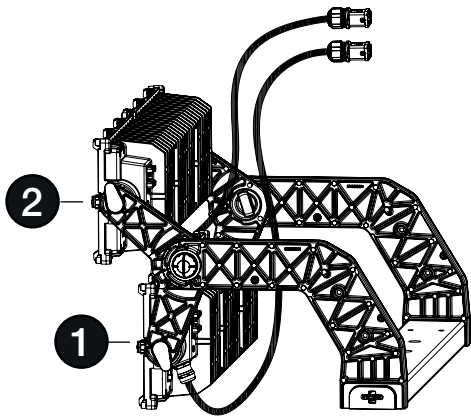



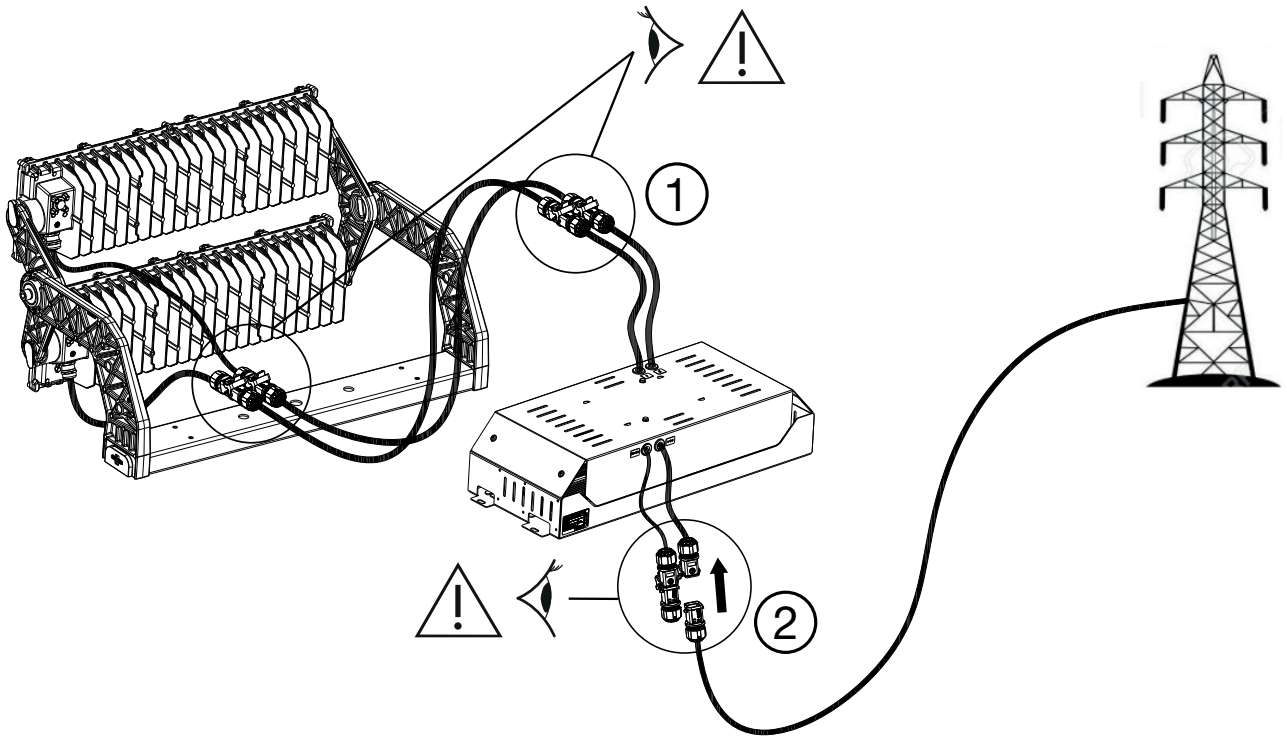

😊 **OK**

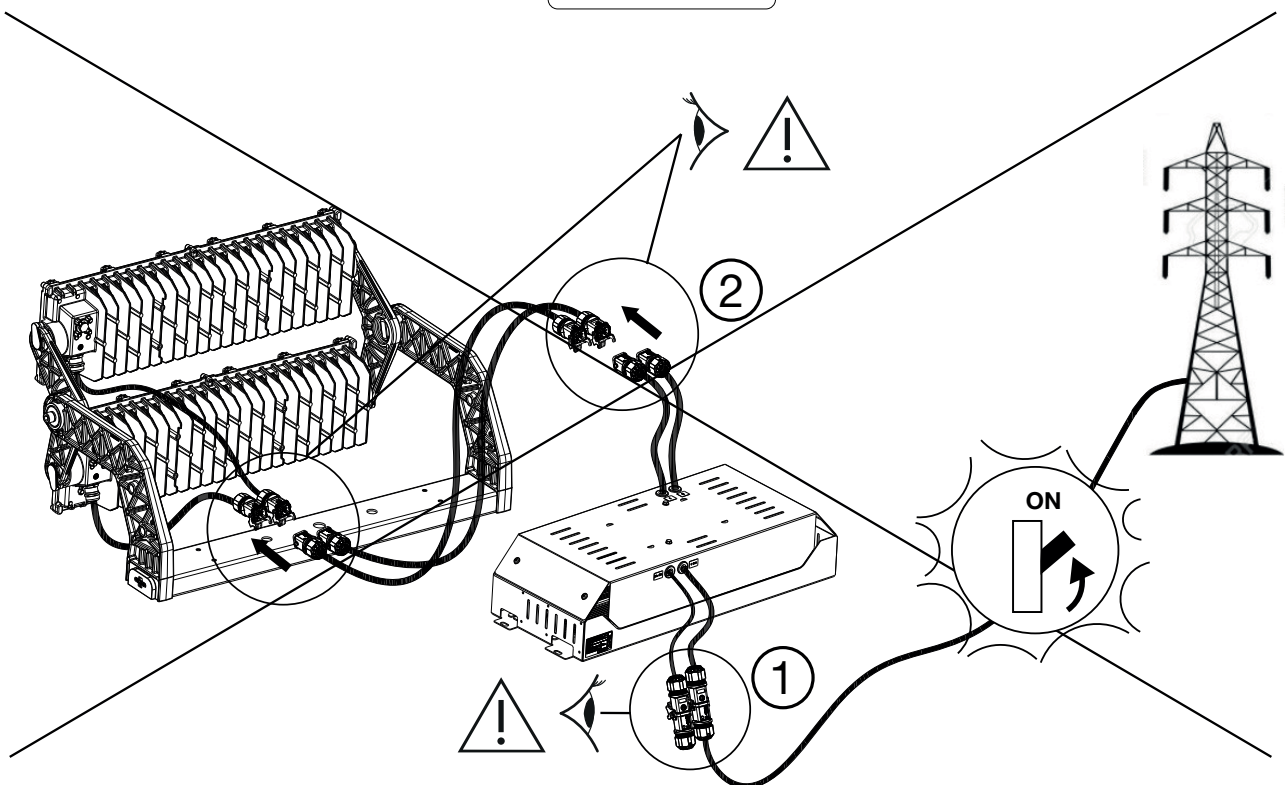

☹ **KO**



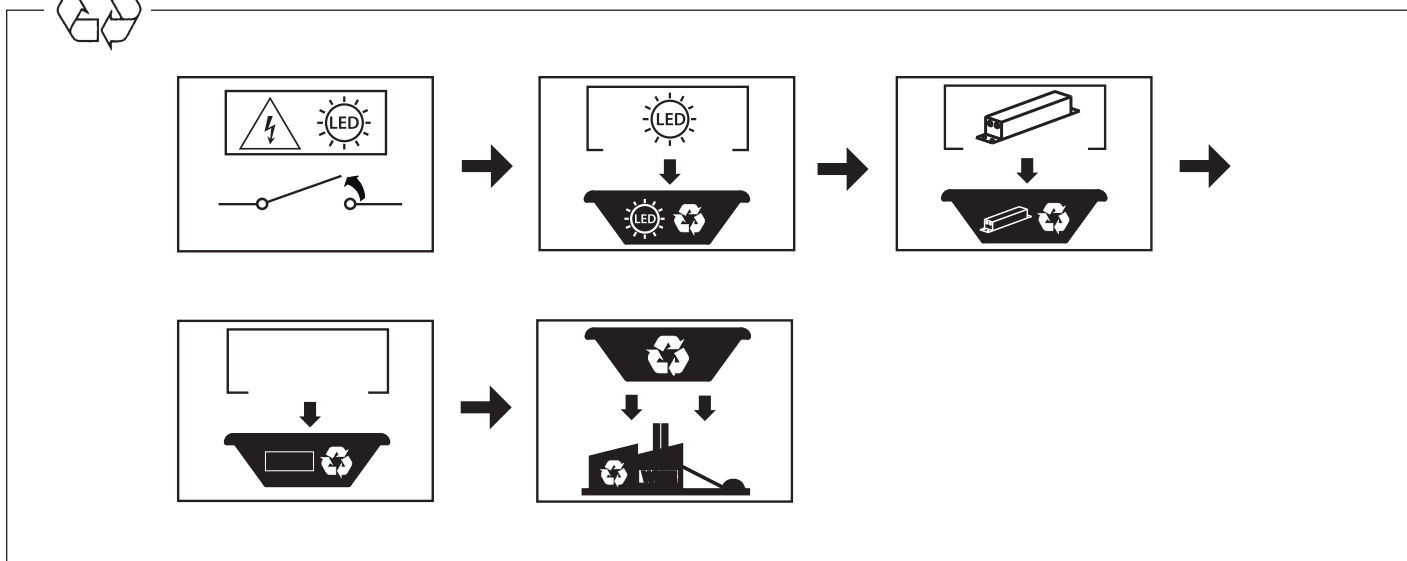

Punto di contatto indicato in adempimento ai fini delle direttive e regolamenti UE applicabili:

Contact details according to the relevant European Directives and Regulations:

GEWISS S.p.A. Via A.Volta, 1 IT-24069 Cenate Sotto (BG) Italy tel: +39 035 946 111 E-mail: qualitymarks@gewiss.com

According to applicable UK regulations, the company responsible for placing the goods in UK market is:

GEWISS UK LTD - Unity House, Compass Point Business Park, 9 Stocks Bridge Way, ST IVES
Cambridgeshire, PE27 5JL, United Kingdom tel: +44 1954 712757 E-mail: gewiss-uk@gewiss.com



+39 035 946 11

8:30 - 12:30 / 14:00 - 18:00

lunedì - venerdì / monday - friday



www.gewiss.com

