

Package Contents

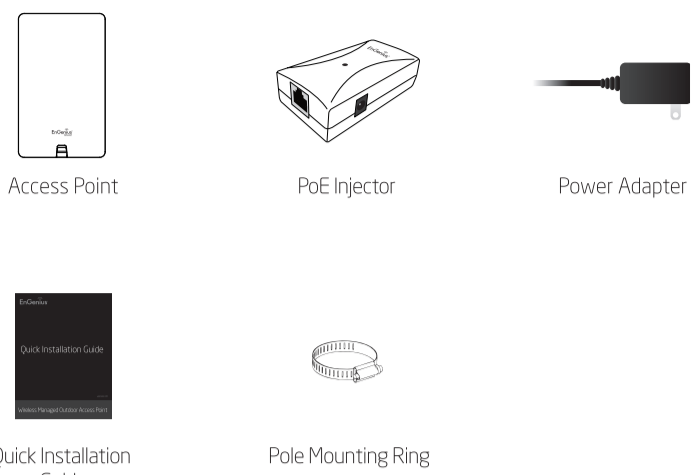

Quick Installation Guide

version 1.0

Wireless Managed Outdoor Access Point

Managed Access Point Installation with Wireless Management Switch

1 Connecting the Access Point (Through EnGenius Management Switch)

- A) Connect one end of the Ethernet Cable into the **main LAN Port (PoE)** of the Managed Access Point and the other end to the **Ethernet Port** on the Wireless Management Switch.
- B) Connect another Ethernet Cable into an Ethernet Port on the front panel of the EnGenius Wireless Management Switch and the other end to the Ethernet Port on the computer.

Note: The Access Point supports both IEEE 802.3at PoE (Power over Ethernet) or the included power injector. You may use either one as the power source. **DO NOT** use both at the same time.

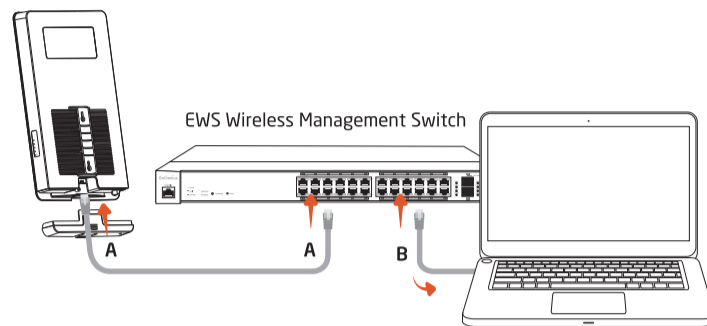

Minimum Requirements

- Broadband Internet Service (Cable or DSL Modem)
- Internet Browser (Internet Explorer, Safari, Firefox, Chrome)

2 IP Address Configuration

- A) Once your computer is on, ensure that your TCP/IP is set to **On** or **Enabled**. Open Network Connections and then click **Local Area Connection**. Select **Internet Protocol Version 4 (TCP/IPv4)**.

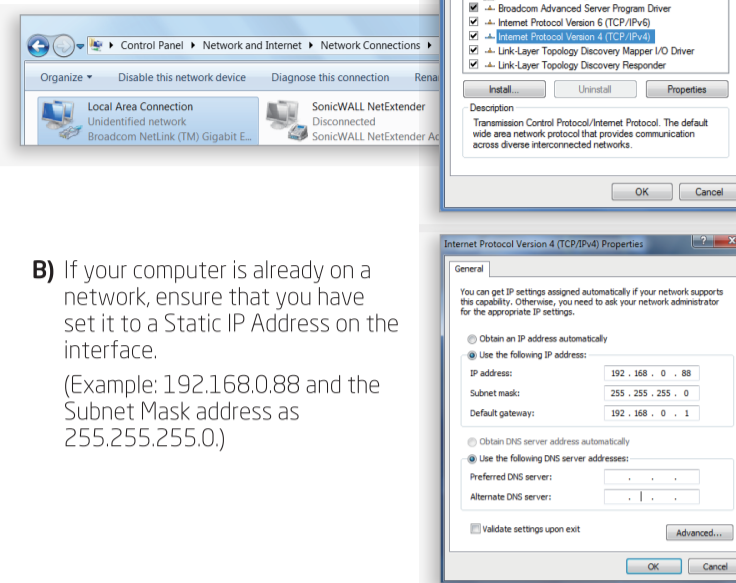

- B) If your computer is already on a network, ensure that you have set it to a Static IP Address on the interface. (Example: 192.168.0.88 and the Subnet Mask address as 255.255.255.0.)

3 Management Switch Setup

- A) Open a web browser on your computer. In the address bar of the web browser, enter **192.168.0.239** and enter.
- B) A login screen will appear. By default, username is **admin** and the password is **password**. Enter the current username and password of the Wireless Management Switch and then click **Login**.

* Your model number may be different in the web browser interface.

- C) The EnGenius Wireless Management Switch User Interface will appear. Make sure the **Controller State** is set to **Enabled**.

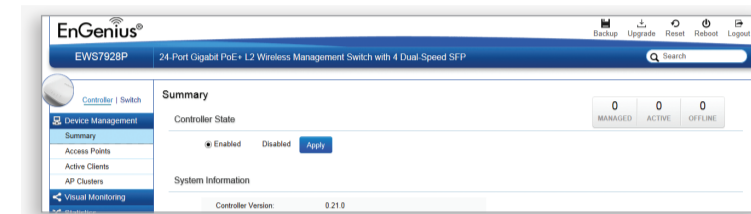

4 Adding Managed AP

(Through EnGenius Wireless Management Switch GUI)

- A) All Managed AP(s) connected to the same network as the Wireless Management Switch will appear on the right side of the screen, under the **AP(s) Detected** list. Locate and select the Managed AP by checking the box and click **Add** to manage the device.

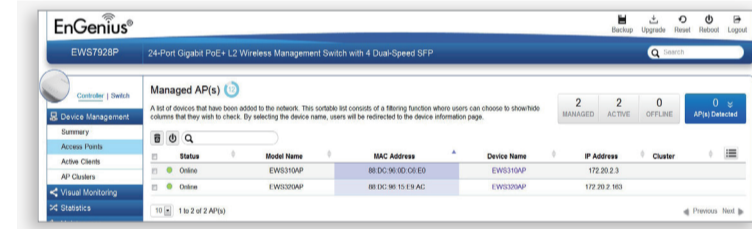
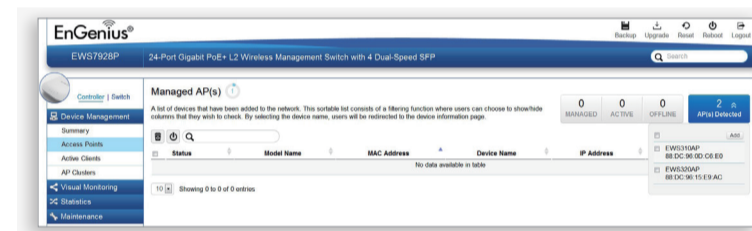

- B) You may configure your Managed AP(s) after you have successfully connected to the Wireless Management Switch through its GUI.

5 Configuring Managed AP

(Through EnGenius Wireless Management Switch GUI)

- A) Configure Managed AP(s) through the GUI interface from the switch for WLAN settings under **Device Management**. Click the "Device Name" in order to configure your Managed AP.

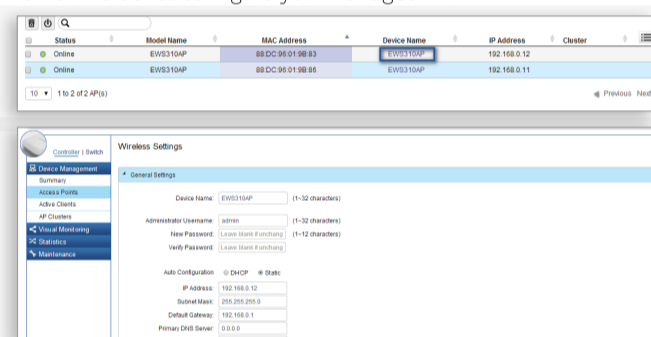

- B) Add Managed AP(s) to specific AP Cluster to save repetitive configuration tasks.

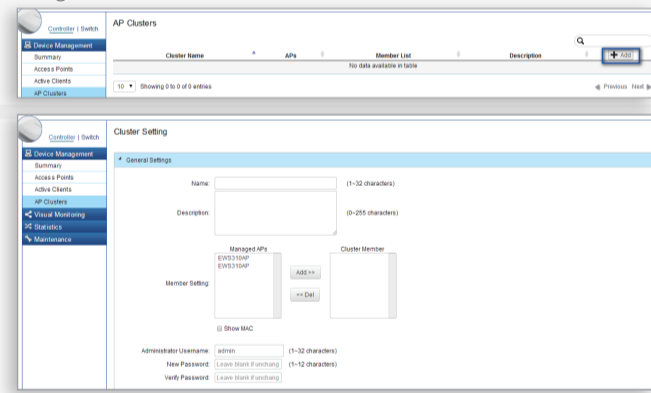

- C) Users may create several clusters simultaneously to accommodate their deployments under **AP Clusters**.

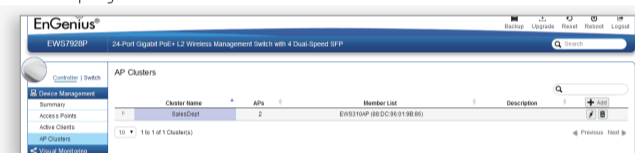

- D) For distinct settings, EnGenius Wireless Management switches still offer individual Managed Access Point customization for cluster members such as different channels that best adapt your local WLAN deployments.

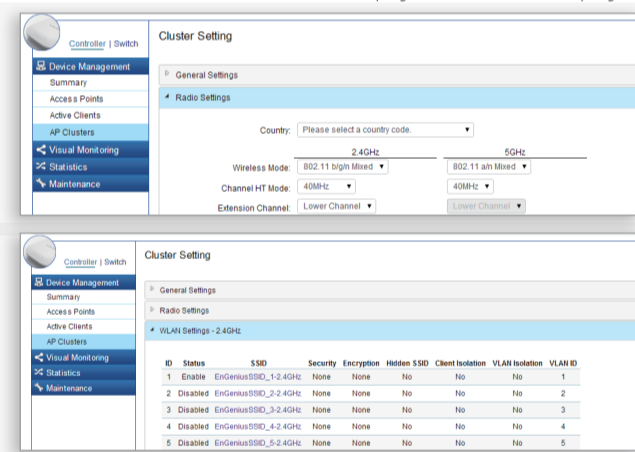

- E) Upon successful connection and setup, user can go through different sections on the web management pages to unleash Managed AP's full features for your WLAN deployment and performance monitoring.

Stand-alone Access Point Installation

1 Connecting the Access Point

- A) Connect one end of the Ethernet cable into the **main LAN port (PoE)** of the Access Point and the other end to the **AP Ethernet port** on the PoE injector.
- B) Connect the **Power Adapter** to the **DC-IN** port of the PoE injector and plug the other end in to an electrical outlet.
- C) Connect the second Ethernet cable into the **LAN port** of the PoE injector and the other end to the Ethernet port on the computer.

Note: The Access Point supports both IEEE 802.3at PoE (Power over Ethernet) or the included power injector. You may use either one as the power source. **DO NOT** use both at the same time.

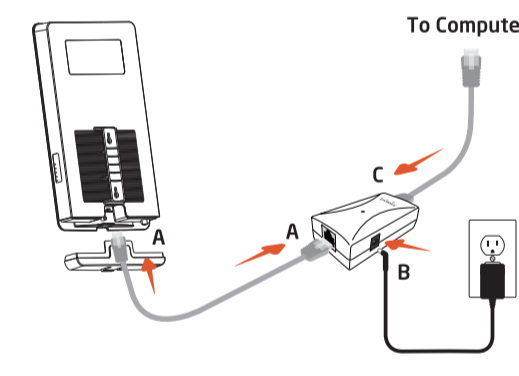

2 IP Address Configuration

- A) Once your computer is on, ensure that your TCP/IP is set to **On** or **Enabled**. Open Network Connections and then click **Local Area Connection**. Select **Internet Protocol Version 4 (TCP/IPv4)**.

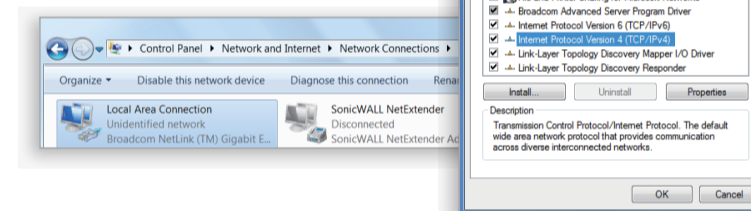

- B) If your computer is already on a network, ensure that you have set it to a Static IP Address on the interface. (Example: 192.168.1.10 and the Subnet Mask address as 255.255.255.0.)

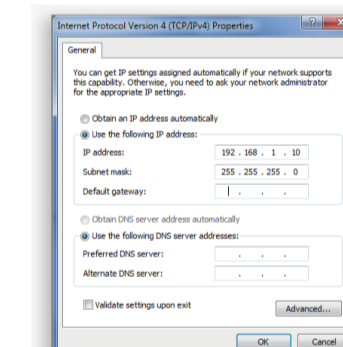

3 Access Point Setup

- A) Open a web browser on your computer. In the address bar of the web browser, enter **192.168.1.1** and enter.

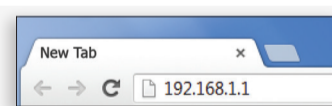

- B) A login screen will appear. By default, the username of the Access Point is **admin** and the password is **admin**. Enter the current username and password of the Access Point and then click **Login**.



- C) The EnGenius Access Point User Interface will appear. This device can operate in Access Point operating mode.

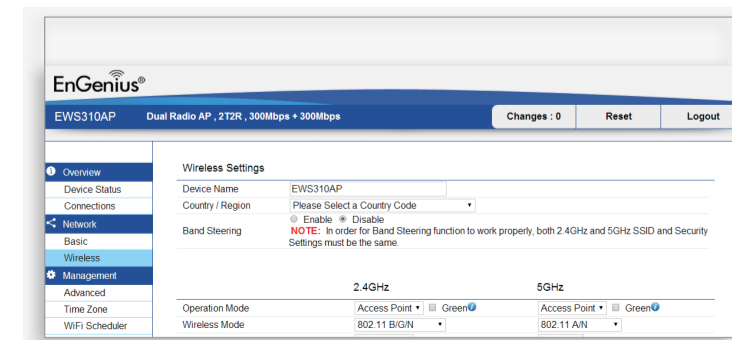

* Your model number may be different in the web browser interface.

Wall Mounting The AP

- A) Attach the location sticker to the desired location on the wall and use a 6mm drill bit to drill the two holes.

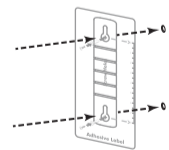

- B) Insert the screw anchors into the 6mm holes then insert the screws and tighten.

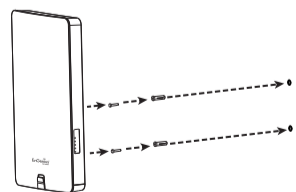

- C) Align the access point over the keyhole mounting slots and insert both screw heads into each keyhole slot. Then slide the access point downward until it's firmly hooked in place.

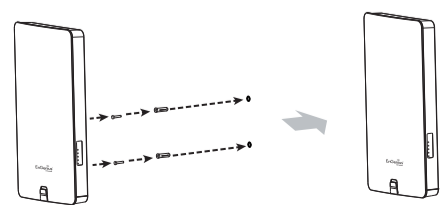

Pole Mounting The AP

- A) Use a flathead screwdriver to unfasten the screw on the pole mounting ring and thread it through the middle tab on the rear of the access point.

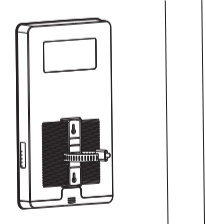

- B) Mount the access point onto the pole by wrapping the ring around the pole and fastening the screw.

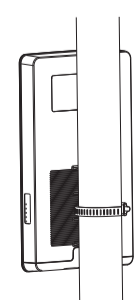

Technical Support

Country of Purchase	Service Center	Service Information
North America www.engeniustech.com	Canada	rma@engeniustech.com Toll Free: (+1) 888 397 2788 Local: (+1) 905 940 8161
	Los Angeles, USA	support@engeniustech.com Toll Free: (+1) 888 735 7888 Local: (+1) 714 432 8668
Central & South America es.engeniustech.com pg.engeniustech.com	Miami, USA	miamisupport@engeniustech.com Miami: (+1) 305 887 7378 Sao Paulo, Brazil: (+55) 11 3957 0303 DF, Mexico: (+52) 55 1163 8894
Europe www.engeniustech.com	Netherlands	support@engeniustech.com (+31) 40 8200 887
Africa CIS Middle East Russia www.engeniustech.com	Dubai, UAE	support@engeniustech.com Toll Free: U.A.E.: 800-EnGenius 800-364-364-87 General: (+971) 4 357 5599
Asia Oceania www.engeniustech.com.sg	Singapore	www.engeniustech.com.sg/e_warranty_form techsupport@engeniustech.com.sg Toll Free: Singapore: 1800 364 3648
Others www.engeniustech.com	Taiwan, R.O.C	technology@senaoo.com

Notes

EnGenius
Maximum data rates are based on draft IEEE 802.11ac and/or IEEE 802.11 standards. Actual throughput and range may vary depending on many factors including environmental conditions, distance between devices, radio interference in the operating environment, and mix of devices in the network. Features and specifications subject to change without notice. This device complies with Part 15 of the FCC Rules. Operation is subject to the following two conditions: (1) this device may not cause harmful interference, and (2) this device must accept any interference received, including interference that may cause undesired operation. Trademarks and registered trademarks are the property of their respective owners. For United States of America: Copyright © 2013 EnGenius Technologies, Inc. All rights reserved.