



Product designation	8-PIN INDUSTRIAL RELAYS		
Product type designation	HR702C		
Contact characteristics			
Contact configuration	2 C/O		
Rated insulation voltage U_i IEC/EN	V	250	
Rated impulse withstand voltage U_{imp}	kV	6	
IEC Conventional free air thermal current I_{th}	A	10	
Rated current (I_n)	A	10	
Relay control voltage	V	110VAC	
Rated operating power AC-1	VA	2500	
Rated operating power AC-15	230 VAC	VA	500
Single-phase motor control	230VAC	kW	1.2
Rated operating current DC-1	30V	A	10
Minimum switching load	V / mA	5 / 100	
Contact impedance	m Ω	100	
Contact material	Ag/Ni		
Operating times			
Closing	ms	<30	
Opening	ms	<30	
Operations			
Mechanical life	cycles	5000000	
Electrical life AC1	cycles	100000	
Coil characteristics			
Average coil consumption AC at 20°C	VA	3	
Average coil consumption DC at 20°C	W	1.5	
Operating range	Closing	% U_n	70...110
	Opening	% U_n	20...55
Maximum cycle frequency	cycles/h	3600	
Mechanical features			
Max socket terminal tightening torque	Nm	0.6	
Socket screw tightening tool (cross / flat blade)	PH1 / 4.5mm		
Conductor section	AWG/Kcmil		
	min	20	
	max	14	
	IEC		
	min	mm ²	0.5
	max	mm ²	2.5

Operating position	normal	Any
Fixing		On 35mm DIN rail and with screw

Ambient conditions

Temperature	Operating temperature		
	min	°C	-40
	max	°C	+55
	Storage temperature		
	min	°C	-40
	max	°C	+70

Other features

Indication	Yes
Mechanical contact position indicator	Yes
Mechanical test actuator	Yes

Dimensions

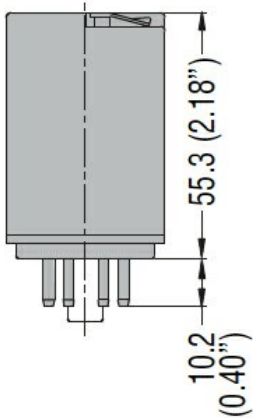

Wiring diagrams

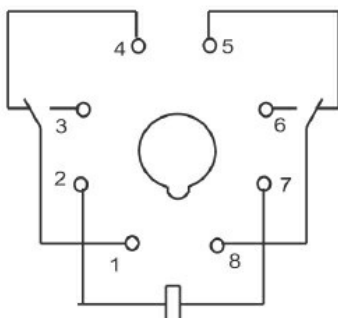
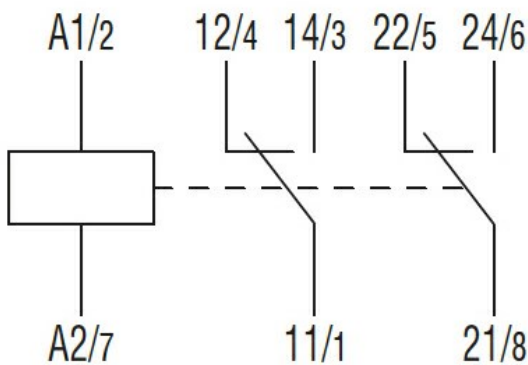

Certifications and compliance

Compliance

IEC/EN 61810

Certificates

CSA

cURus

EAC

ETIM classification

ETIM 8.0

EC001437 -
Switching relay