



LBV331-GXAGDRAMX0500

LBV301

VIBRATING LEVEL SWITCH

SICK
Sensor Intelligence.



Ordering information

Type	Part no.
LBV331-GXAGDRAMX0500	6057162

Other models and accessories → www.sick.com/LBV301

Illustration may differ



Detailed technical data

Features

Medium	Bulk solids
Measurement	Switch
Probe length	500 mm
Process pressure	-1 bar ... 16 bar
Process temperature	-50 °C ... +150 °C
Fill material density	≥ 0.02 g/cm ³
ATEX approval	ATEX II 1D, 1/2D, 2D Ex ta ta/tb tb IIIC Tx Da, Da/Db, Db
Type examination	BVS 17 ATEX E 098 X

Performance

Accuracy of sensor element	± 10 mm
Reproducibility	≤ 5 mm
Response time	500 ms when covered / 1,000 ms when uncovered
MTBF	4,17*10 ⁶ h

Electronics

Power consumption	5 mA ... 30 mA
Initialization time	< 2 s
VDE protection class 1	✓
Connection type	M20 x 1.5
Output signal	Double relay (DPDT)
Supply voltage	Double relay (DPDT): 20 V DC ... 72 V DC / 20 V AC ... 253 V AC
Hysteresis	10 mm
Output current	> 10 µA; < 3A AC, 1A DC
Enclosure rating	IP66 / IP67

Mechanics

Process connection	G 1½ A PN 16
Housing material	Aluminum
Sensor material	Stainless steel 316L, 318S

Ambient data

Ambient operating temperature	-40 °C ... +70 °C
Ambient temperature, storage	-40 °C ... +80 °C

Classifications

ECLASS 5.0	27273202
ECLASS 5.1.4	27273202
ECLASS 6.0	27273202
ECLASS 6.2	27273202
ECLASS 7.0	27273202
ECLASS 8.0	27273202
ECLASS 8.1	27273202
ECLASS 9.0	27273202
ECLASS 10.0	27273202
ECLASS 11.0	27273202
ECLASS 12.0	27273106
ETIM 5.0	EC002654
ETIM 6.0	EC002654
ETIM 7.0	EC002654
ETIM 8.0	EC002654
UNSPSC 16.0901	41111938

Type code

LBV331 type code

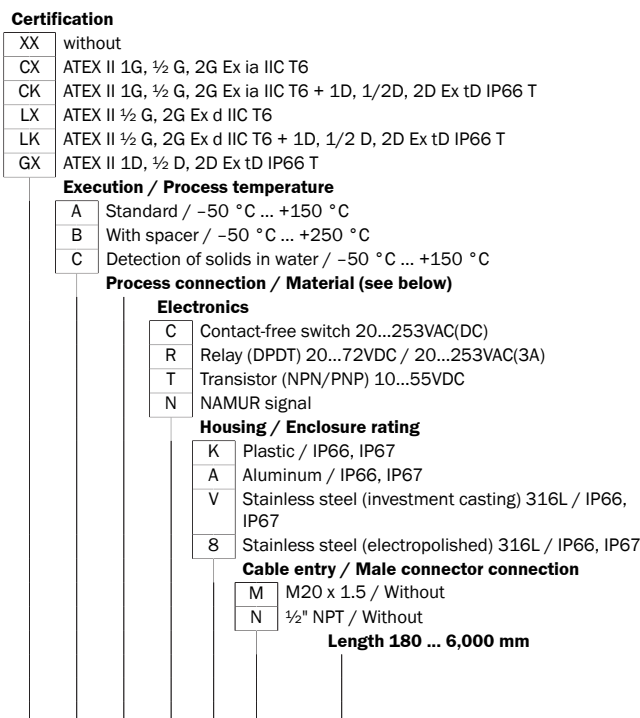

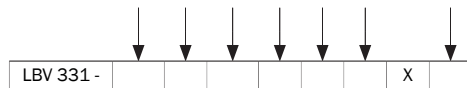

Not all variants of the type code can be combined!

Process connection / Material

GC	Thread G 1 (DIN 3852-A) PN 16 / 316L	MF	Flange DN 100, PN 16, form C, DIN2501 / 316L
GR	Thread G 1 (DIN 3852-A) PN 16 / 316L, Ra < 0.8µm	OF	Flange DN 100, PN 40, form C, DIN2501 / 316L
GD	Thread G 1 ½ (DIN 3852-A) PN 16 / 316L	3F	Flange DN 125, PN 6, form C, DIN2501 / 316L
GT	Thread G 1 ½ (DIN 3852-A) PN 16 / 316L, Ra < 0.8µm	QF	Flange DN 150, PN 16, form C, DIN2501 / 316L
ND	Thread 1 ½" NPT (ASME B1.20.1) PN 16 / 316L	2F	Flange DN 200, PN 10, form C, DIN2501 / 316L
NT	Thread 1 ½" NPT (ASME B1.20.1) PN 16 / 316L, Ra < 0.8µm	EB	Flange DN 50, PN 40 EN1092-1 form B1 / 316L
CT	Tri-Clamp 1 ½" / 316L Ra < 0.8µm	DA	Flange 1 ½" 150 lb RF, ANSI B16.5 / 316L
CV	Tri-Clamp 2" / 316L Ra < 0.8µm	EA	Flange 1 ½" 300 lb RF, ANSI B16.5 / 316L
CQ	Tri-Clamp 2 ½" / 316L Ra < 0.8µm	HA	Flange 2" 150 lb RF, ANSI B16.5 / 316L
CM	Tri-Clamp 3 ½" / 316L Ra < 0.8µm	IA	Flange 2" 300 lb RF, ANSI B16.5 / 316L
RP	Pipe connection, DN 40, PN 40, DIN 11851 / 316L Ra < 0.8µm	OA	Flange 3" 150 lb RF, ANSI B16.5 / 316L
RF	Pipe connection, DN 40, PN 40, DIN 11864-1 form A / 316L Ra < 0.8µm	OE	Flange 3" 150 lb FF, ANSI B16.5 / 316L
RH	Pipe connection, DN 65, PN 25, DIN 11851 / 316L Ra < 0.8µm	PA	Flange 3" 300 lb RF, ANSI B16.5 / 316L
TV	Tuchenhagen Varivent, DN 32...1 ½" PN 25 / 316L Ra < 0.8µm	PE	Flange 3" 300 lb FF, ANSI B16.5 / 316L
C2	Bundle clamp, DN 40, PN 40, DIN, 11864-3 form A / 316L Ra < 0.8µm	JA	Flange 3 ½" 150 lb RF, ANSI B16.5 / 316L
BF	Flange, DN 32, PN 40, form C, DIN 2501 / 316L	SA	Flange 4" 150 lb RF, ANSI B16.5 / 316L
DF	Flange, DN 40, PN 40, form C, DIN 2501 / 316L	UA	Flange 4" 300 lb RF, ANSI B16.5 / 316L
EF	Flange, DN 50, PN 40, form C, DIN 2501 / 316L	AU	Flange DN 50, 10K RF, JIS / 316L
4F	Flange, DN 65, PN 16, form C, DIN 2501 / 316L	HU	Flange DN 65, 10K RF, JIS / 316L
No error	Flange, DN 80, PN 40, form C, DIN 2501 / 316L	BU	Flange DN 80, 10K RF, JIS / 316L
ZF	Flange, DN 100, PN 6, form C, DIN 2501 / 316L	CU	Flange DN 100, 10K RF, JIS / 316L

Dimensional drawing (Dimensions in mm (inch))

LBV331 flange

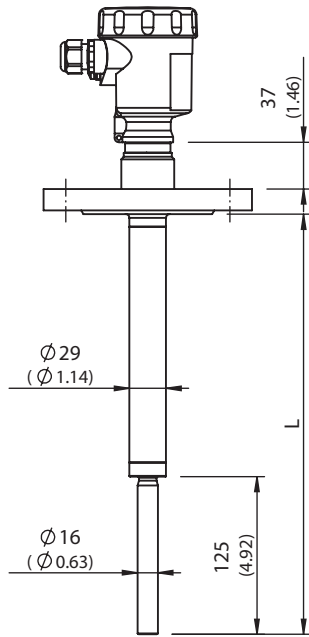

All dimensions in mm (inch)

LBV331 threaded version G 1 1/2 A

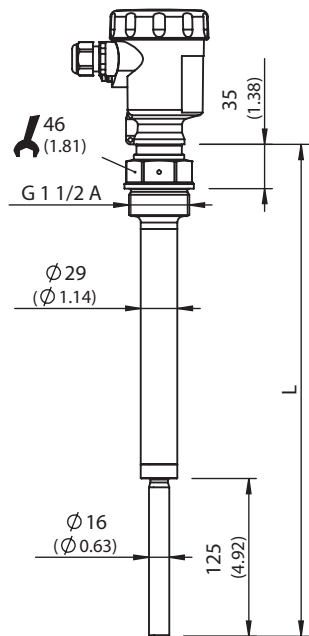

All dimensions in mm (inch)

LBV331 threaded version G 1 A

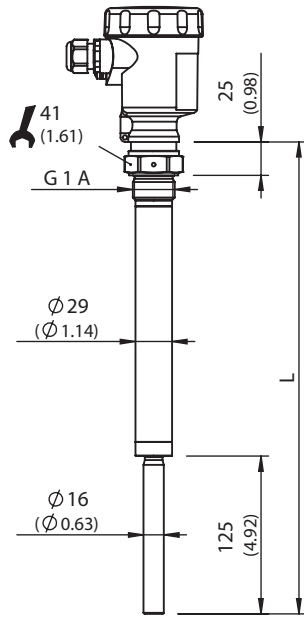

All dimensions in mm (inch)

Connection diagram

Double relay connection diagram

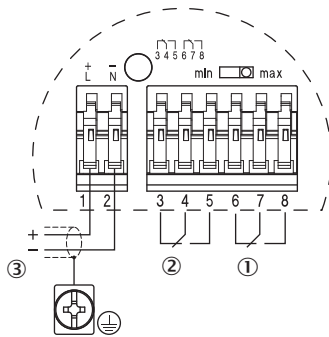

- ① Relay output
- ② Relay output
- ③ Power supply

Instruction for installation

Horizontal mounting

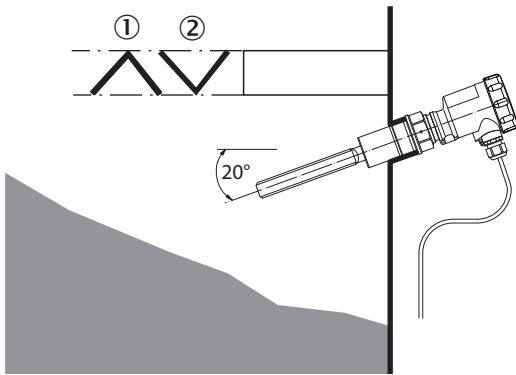

- ① Protective sheet
- ② Concave protective sheet for abrasive solids

Characteristic curve

Ambient temperature - process temperature

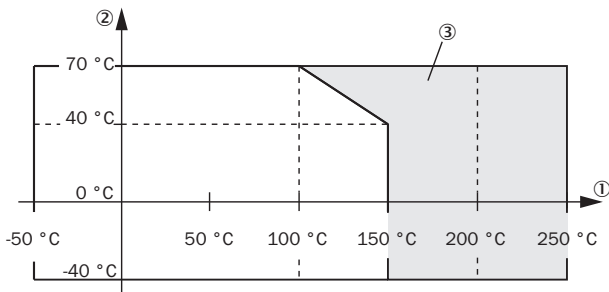

- ① Process temperature in °C (°F)
- ② Ambient temperature in °C (°F)
- ③ Temperature range with temperature adapter

SICK AT A GLANCE

SICK is one of the leading manufacturers of intelligent sensors and sensor solutions for industrial applications. A unique range of products and services creates the perfect basis for controlling processes securely and efficiently, protecting individuals from accidents and preventing damage to the environment.

We have extensive experience in a wide range of industries and understand their processes and requirements. With intelligent sensors, we can deliver exactly what our customers need. In application centers in Europe, Asia and North America, system solutions are tested and optimized in accordance with customer specifications. All this makes us a reliable supplier and development partner.

Comprehensive services complete our offering: SICK LifeTime Services provide support throughout the machine life cycle and ensure safety and productivity.

For us, that is “Sensor Intelligence.”

WORLDWIDE PRESENCE:

Contacts and other locations –www.sick.com