



IMR30-15BPSTC0S

IMR

INDUCTIVE PROXIMITY SENSORS

SICK
Sensor Intelligence.



Ordering information

Type	Part no.
IMR30-15BPSTC0S	6069279

Other models and accessories → www.sick.com/IMR



Detailed technical data

Features

Housing	Cylindrical thread design
Housing	Standard design
Thread size	M30
Diameter	Ø 30 mm
Sensing range S_n	15 mm
Safe sensing range S_a	12.1 mm
Installation type	Flush
Switching frequency	1,000 Hz
Connection type	Male connector M12, 4-pin
Switching output	PNP
Output function	NO
Electrical wiring	DC 3-wire
Enclosure rating	IP68
Special features	Reduction factor 1, Weld immune
Special applications	Welding range, Difficult application conditions
Items supplied	Mounting nut, brass, PTFE coating (2x) Washer, brass, PTFE coating, with locking teeth (2x)

Mechanics/electronics

Supply voltage	10 V DC ... 30 V DC
Ripple	≤ 10 %
Voltage drop	≤ 1.8 V ¹⁾
Hysteresis	3 % ... 15 %
Reproducibility	≤ 2 % ^{2) 3)}

¹⁾ At I_a max.

²⁾ Supply voltage U_B and constant ambient temperature T_a .

³⁾ Of S_r .

⁴⁾ -25 °C ... +70 °C.

⁵⁾ Reference voltage: 50 V DC.

Temperature drift (of S_r)	≤ ± 10 % ≤ ± 15 % ⁴⁾
Continuous current I_a	≤ 200 mA
No load current	≤ 15 mA
Off-state current	≤ 0.1 mA
Short-circuit protection	✓
Reverse polarity protection	✓
Magnetic field strength	≤ 100 mT
Shock and vibration resistance	30 g, 11 ms / 10 ... 55 Hz, 1 mm
Ambient operating temperature	-30 °C ... +85 °C
Housing material	PTFE coating, brass
Sensing face material	Plastic, PTFE coating
Housing length	62 mm
Thread length	46 mm
Tightening torque, max.	Typ. 7.5 Nm
Protection class	II ⁵⁾
UL File No.	E191603

1) At I_a max.

2) Supply voltage U_B and constant ambient temperature T_a.

3) Of S_r.

4) -25 °C ... +70 °C.

5) Reference voltage: 50 V DC.

Safety-related parameters

MTTF_D	139 years
DC_{avg}	0%
T_M (mission time)	20 years

Reduction factors

Note	The values are reference values which may vary
Reduction factor	Reduction factor 1
Stainless steel (V2A, 304)	1
Aluminum (Al)	1
Copper (Cu)	1
Brass (Br)	1

Installation note

Remark	Associated graphic see "Installation"
A	30 mm
B	30 mm
C	30 mm
D	45 mm
E	0 mm
F	90 mm
G	90 mm

Classifications

ECLASS 5.0	27270101
ECLASS 5.1.4	27270101
ECLASS 6.0	27270101
ECLASS 6.2	27270101
ECLASS 7.0	27270101
ECLASS 8.0	27270101
ECLASS 8.1	27270101
ECLASS 9.0	27270101
ECLASS 10.0	27270101
ECLASS 11.0	27270101
ECLASS 12.0	27274001
ETIM 5.0	EC002714
ETIM 6.0	EC002714
ETIM 7.0	EC002714
ETIM 8.0	EC002714
UNSPSC 16.0901	39122230

Installation note

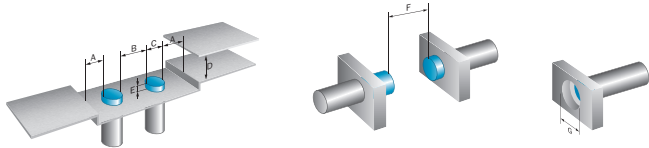

Connection diagram

Cd-007

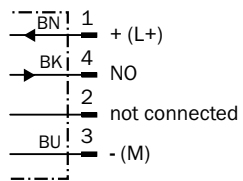

Response diagram

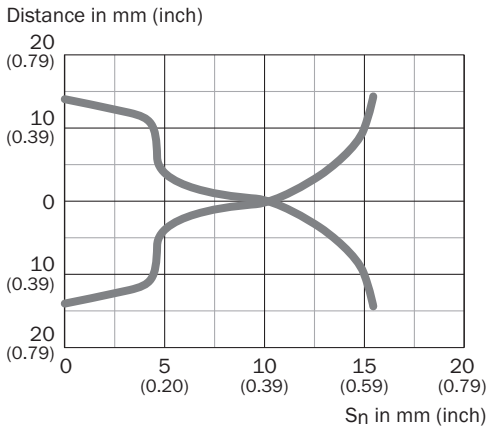

Dimensional drawing (Dimensions in mm (inch))

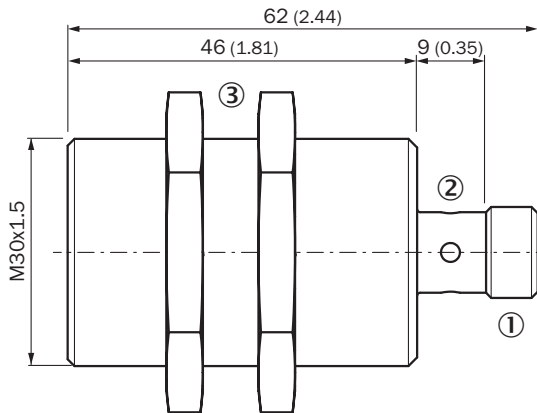





- ① M12 x 1
- ② LED output state, yellow
- ③ Fastening nuts (2x); width across 36, metal

Recommended accessories

Other models and accessories → www.sick.com/IMR

	Brief description	Type	Part no.
Mounting brackets and plates			
	Mounting bracket for M30 sensors, steel, zinc coated, without mounting hardware	BEF-WN-M30	5308445

	Brief description	Type	Part no.
Others			
	<ul style="list-style-type: none"> • Connection type head A: Female connector, M12, 4-pin, straight, A-coded • Connection type head B: Flying leads • Signal type: Sensor/actuator cable • Cable: 5 m, 4-wire, PUR, halogen-free • Description: Sensor/actuator cable, unshielded • Application: Zones with oils and lubricants, Drag chain operation, Robot 	YF2A14-050UB3XLEAX	2095608
	<ul style="list-style-type: none"> • Connection type head A: Female connector, M12, 4-pin, straight, A-coded • Connection type head B: Flying leads • Signal type: Sensor/actuator cable • Cable: 2 m, 4-wire, PUR, halogen-free • Description: Sensor/actuator cable, unshielded • Application: Weld-spark resistant, Robot 	YF2A14-020UW1XLEAX	2104883
	<ul style="list-style-type: none"> • Connection type head A: Female connector, M12, 4-pin, straight, A-coded • Connection type head B: Flying leads • Signal type: Sensor/actuator cable • Cable: 5 m, 4-wire, PUR, halogen-free • Description: Sensor/actuator cable, unshielded • Application: Weld-spark resistant, Robot 	YF2A14-050UW1XLEAX	2104884
	<ul style="list-style-type: none"> • Connection type head A: Female connector, M12, 4-pin, angled, A-coded • Connection type head B: Flying leads • Signal type: Sensor/actuator cable • Cable: 2 m, 4-wire, PUR, halogen-free • Description: Sensor/actuator cable, unshielded • Application: Weld-spark resistant, Robot 	YG2A14-020UW1XLEAX	2104886
	<ul style="list-style-type: none"> • Connection type head A: Female connector, M12, 4-pin, angled, A-coded • Connection type head B: Flying leads • Signal type: Sensor/actuator cable • Cable: 5 m, 4-wire, PUR, halogen-free • Description: Sensor/actuator cable, unshielded • Application: Weld-spark resistant, Robot 	YG2A14-050UW1XLEAX	2104887

SICK AT A GLANCE

SICK is one of the leading manufacturers of intelligent sensors and sensor solutions for industrial applications. A unique range of products and services creates the perfect basis for controlling processes securely and efficiently, protecting individuals from accidents and preventing damage to the environment.

We have extensive experience in a wide range of industries and understand their processes and requirements. With intelligent sensors, we can deliver exactly what our customers need. In application centers in Europe, Asia and North America, system solutions are tested and optimized in accordance with customer specifications. All this makes us a reliable supplier and development partner.

Comprehensive services complete our offering: SICK LifeTime Services provide support throughout the machine life cycle and ensure safety and productivity.

For us, that is “Sensor Intelligence.”

WORLDWIDE PRESENCE:

Contacts and other locations –www.sick.com