

SLBt Biodynamic



Product information

Introducing Tungsram's latest LED road and street fixture, the SLBt, which makes the advantages of outdoor LED lighting available for everyone, even those on tight budgets. Designed to replace 35-100W HID and 24-36W CFL fixtures, the SLBt is a great LED solution for minor roads, residential streets and other public spaces where modest levels of illumination are required. The luminaire changes its color temperature according to an automatic program, which supports the function of the "biological rhythm" of our body. This process is responsible for the level of melatonin and cortisol hormone in our body, which significantly affects our night's rest.

Application areas



Pedestrian street



Car park



Street & residential road lighting

Driver features

- Electronic, dimmable driver: DALI, CLO and dynadim from 22-73W

Performance

- Rated luminous flux range: 1000-2500 lm at 1800K; 1030-4800 lm at 4000K;
- Rated luminaire efficacy: Up to 115lm/W at 4000K, 77lm/W at 1800K
- Photometric code: 618/xx9, 740/559
- Rated median useful life and the associated rated LM factor
L90B50 > 56.000 hours L80B50: > 132.000 hours
- Rated abrupt failure value: 10 %
- Lumen maintenance code: 9
- Rated ambient temperature (tq) related to performance for a luminaire: 25°C

Definitions and tolerances according to IEC62722-2-1:2014

Structures and materials

- Housing material: die-cast aluminium body, corrosion resistant screws and brackets
- Optic material: coated polycarbonate or aluminium
- Colour: RAL7035
- Optical cover: UV stabilized polycarbonate

Installation and maintenance

Mounting options:

- Side mount bracket ø42mm-60mm
- Universal coupler side ø42mm-60mm
- Universal coupler post ø42mm-60mm
- Universal Coupler can be adjusted -15°, -10°, -5°, 0°, +5°, +10°, +15° by 5° degree steps
- Recommended mounting height: 4-15m
- Weight: 5 kg
- Only two hand-tools required for installing the fixture
- Storage temperature up to 85°C.
- Ambient temperature from -40°C to +25°C

Optics

Available photometric distributions:

- Narrow Asymmetric – medium (B, B2, B5)
- Asymmetric forward – very short (D)
- Asymmetric – medium (E5)

Rated colour rendering index: >60 at 1800K, >70 at 4000K

Rated correlated colour temperatures: 1800K- 4000K

S/P rating for: 1800K - 0.5 ,4000K - 1.56

ULOR: 0

Rated initial chromaticity co-ordinate values for 1800K, 4000K:

- CIE(x=0.561, y=0.430) 5SDC
- CIE(x= 0.38, y= 0.38) 5SDC

Standards and regulation

CE, Directive 2014/30/EC, 2014/35/EC, 2009/125/EC
1194/2012/EU, 2011/65/EC, EN 60598, EN 62471, EN 55015,
EN 61000, EN 62493, EN 61547.

Electrical

Input voltage and frequency: 220-240V, 50-60Hz
Class I
Surge immunity: 10kV
Rated input power: 22W to 73W

Dimensions (mm)

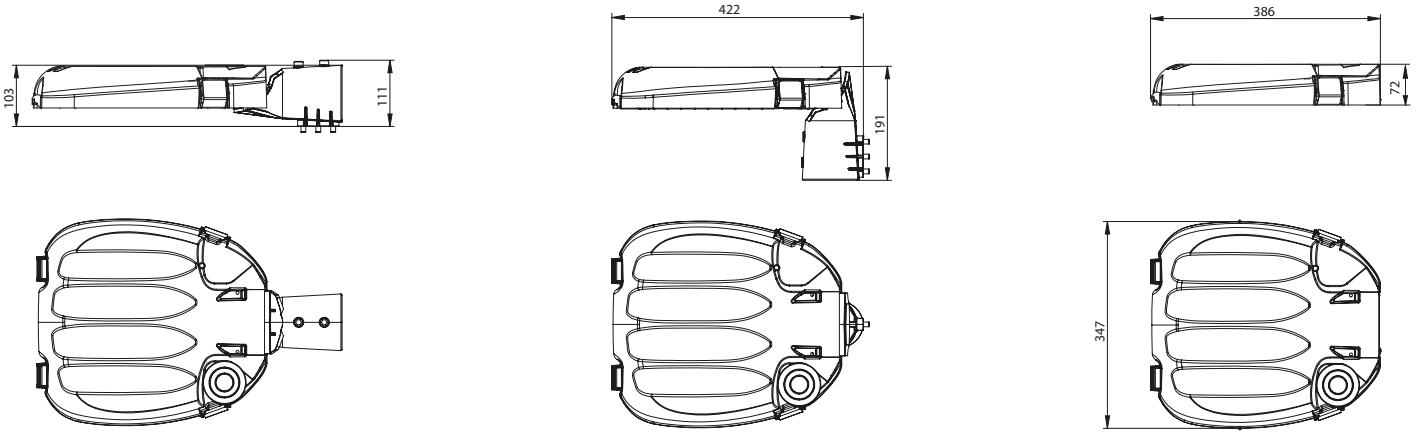

Order logic

Name	Gen.	Front Glass	Optics	Power (W)	CCT (K)	Control	Accessories	IEC Protection Classes	Precabbling	Mounting	Color
SLBt	BD	F-Flat Glass	B D B2 B5 E5	22* 31* 45* 59* 73*	18-40 -1800- 4000K	BYxx - Bio + DynaDIM** BYLxx - Bio + DynaDIM + CLO**	N - Dummy fuse F - Fuse	C1 - Class I	N - No precabbling	S60 - Side mounted/, 42-60mm & Post top/, 48-60mm U60 - Universal mounted, 42-60mm	R7035 XXXXX***

Example: SLBT/BD/F/B5/59/18-40/BYL04/F/C1/N/S60

Exceptions:

*Maximum watt, for typical watt please ask technology

**x is integer

***R7035 is a standard color, for other color please use 5 characters