



ZLD18-2AB5B2

Z18 Simple Sense

HYBRID PHOTOELECTRIC SENSORS

SICK
Sensor Intelligence.



Illustration may differ



Ordering information

Type	Part no.
ZLD18-2AB5B2	1095726

Other models and accessories → www.sick.com/Z18_Simple_Sense

Detailed technical data

Features

Functional principle	Photoelectric retro-reflective sensor
Functional principle detail	Dual lens
Dimensions (W x H x D)	13.6 mm x 34.8 mm x 21.9 mm
Housing design (light emission)	Hybrid
Thread diameter (housing)	M18
Mounting system type	M18, head/side (24.1 ... 25.4 mm)
Housing color	Blue
Sensing range max.	0 m ... 7.8 m ¹⁾
Sensing range	0 m ... 6.8 m ¹⁾
Type of light	Visible red light
Light source	PinPoint LED
Light spot size (distance)	Ø 25 mm (1,000 mm)
Wave length	625 nm

¹⁾ Reflector PL80A.

Mechanics/electronics

Supply voltage U_B	10 V DC ... 30 V DC
Ripple	< 10 %
Current consumption	≤ 15 mA ¹⁾
Switching output	Push-pull: PNP/NPN
Switching mode	Light switching, Dark switching

¹⁾ Without load.

²⁾ Signal transit time with resistive load.

³⁾ With light/dark ratio 1:1.

⁴⁾ A = V_S connections reverse-polarity protected.

⁵⁾ B = inputs and output reverse-polarity protected.

⁶⁾ D = outputs overcurrent and short-circuit protected.

Switching output detail	
Switching output Q1	Push-pull: PNP/NPN, Light switching
Switching output Q2	Push-pull: PNP/NPN, Dark switching
Output current I_{max}	100 mA
Response time	≤ 500 μs ²⁾
Switching frequency	1,000 kHz ³⁾
Connection type	Cable with male connector M8, 4-pin, snap, 150 mm
Cable material	PVC
Conductor cross section	0.13 mm ²
Circuit protection	A ⁴⁾ B ⁵⁾ D ⁶⁾
Protection class	III
Weight	4.54 g
Polarisation filter	✓
Housing material	Plastic, ABS
Optics material	Plastic, PMMA
Enclosure rating	IP67
Ambient operating temperature	-40 °C ... +55 °C
Ambient temperature, storage	-40 °C ... +70 °C
UL File No.	E189383

¹⁾ Without load.

²⁾ Signal transit time with resistive load.

³⁾ With light/dark ratio 1:1.

⁴⁾ A = V_S connections reverse-polarity protected.

⁵⁾ B = inputs and output reverse-polarity protected.

⁶⁾ D = outputs overcurrent and short-circuit protected.

Classifications

ECLASS 5.0	27270902
ECLASS 5.1.4	27270902
ECLASS 6.0	27270902
ECLASS 6.2	27270902
ECLASS 7.0	27270902
ECLASS 8.0	27270902
ECLASS 8.1	27270902
ECLASS 9.0	27270902
ECLASS 10.0	27270902
ECLASS 11.0	27270902
ECLASS 12.0	27270902
ETIM 5.0	EC002717
ETIM 6.0	EC002717
ETIM 7.0	EC002717

ETIM 8.0	EC002717
UNSPSC 16.0901	39121528

Connection type/pinouts

Connection type	Cable with male connector M8, 4-pin, snap, 150 mm
Connection type Detail	
Conductor cross section	0.13 mm ²
Cable material	PVC
Pinouts	
BN 1	+ (L+)
WH 2	Q ₂
BU 3	- (M)
BK 4	Q ₁

Dimensional drawing (Dimensions in mm (inch))

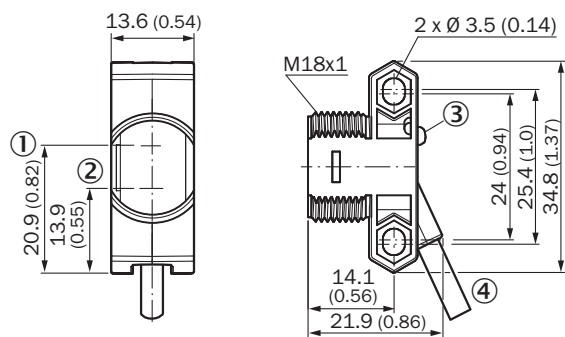

- ① Optical axis, sender
- ② Optical axis, receiver
- ③ LED status indicator
- ④ Connection

Connection type

Pinouts, see Technical details: **Connection type/pinouts**

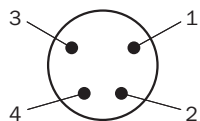

Male connector, M8, 4-pin, uncoded

Characteristic curve

Function reserve

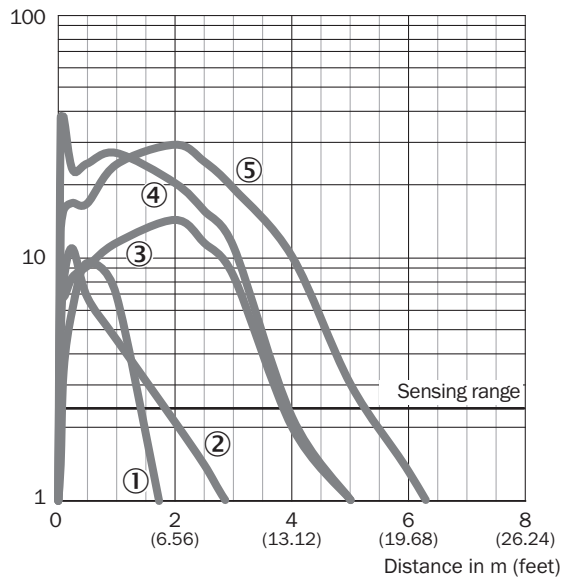

- ① Reflector PL23 FT
- ② Reflector PL20A
- ③ Reflector P250
- ④ Reflector PL40A
- ⑤ Reflector PL80A



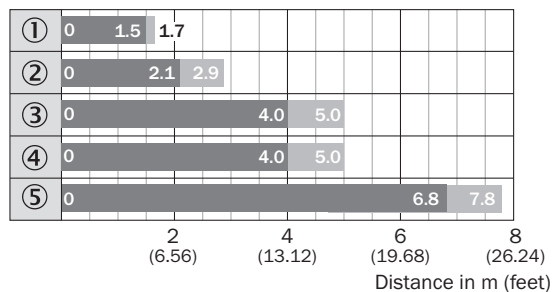

Sensing range diagram



- Sensing range
- Sensing range typ. max.
- ① Reflector PL23 FT
- ② Reflector PL20A
- ③ Reflector P250
- ④ Reflector PL40A
- ⑤ Reflector PL80A

Recommended accessories

Other models and accessories → www.sick.com/Z18_Simple_Sense

	Brief description	Type	Part no.
Mounting brackets and plates			
	Universal mounting bracket for reflectors, steel, zinc coated	BEF-WN-REFX	2064574
Plug connectors and cables			
	<ul style="list-style-type: none"> • Connection type head A: Male connector, M8, 4-pin, straight • Description: Unshielded • Connection systems: Screw-type terminals • Permitted cross-section: 0.14 mm² ... 0.5 mm² 	STE-0804-G	6037323
Reflectors			
	Rectangular, screw connection, 51 mm x 61 mm, PMMA/ABS, Screw-on, 2 hole mounting	P250	5304812
Others			
	<ul style="list-style-type: none"> • Connection type head A: Female connector, M8, 4-pin, straight, A-coded • Connection type head B: Flying leads • Signal type: Sensor/actuator cable • Cable: 5 m, 4-wire, PVC • Description: Sensor/actuator cable, unshielded • Application: Zones with chemicals 	YF8U14-050VA3XLEAX	2095889

SICK AT A GLANCE

SICK is one of the leading manufacturers of intelligent sensors and sensor solutions for industrial applications. A unique range of products and services creates the perfect basis for controlling processes securely and efficiently, protecting individuals from accidents and preventing damage to the environment.

We have extensive experience in a wide range of industries and understand their processes and requirements. With intelligent sensors, we can deliver exactly what our customers need. In application centers in Europe, Asia and North America, system solutions are tested and optimized in accordance with customer specifications. All this makes us a reliable supplier and development partner.

Comprehensive services complete our offering: SICK LifeTime Services provide support throughout the machine life cycle and ensure safety and productivity.

For us, that is “Sensor Intelligence.”

WORLDWIDE PRESENCE:

Contacts and other locations –www.sick.com