



Product designation	Surge Protection Device (SPD)
Product type designation	SG2
Operating voltage type	AC
Application	AC Power lines
Number of poles	2P
Number of DIN modules	2
Relay output	Yes
SPD according to IEC/EN 61643-11	YES

#### Electrical features

IEC Maximum continuous voltage $U_c$	V	300
IEC Maximum discharge current $I_{max}$ 8/20 (L-N/N-PE)	kA	50
IEC Rated discharge current (IEC) $I_n$ 8/20 (L-N/N-PE)	kA	20
IEC Voltage protection level $U_p$ (L-N/N-PE)	kV	<1.5
IEC Follow current $I_f$ (N-PE) rms	A	No
Tripping time $t_a$ (L-N/N-PE)	ns	<25
Thermal insulation protection		YES
IEC Backup protection fuse with supply fuse >315A (L-N/N-PE)	Class/A	315A / 250A Gg
IEC Maximum short circuit current at 50Hz	kA	25 / 50
Status indicator - operating / end of life		Frontal indication/Aux contact

#### Ambient conditions

Operating temperature	min	°C	-40
	max	°C	+85
Max altitude		m	2000

#### Mechanical features

Fixing		Din rail
Conductor section Flexible max (IEC)	mm <sup>2</sup>	25
Conductor section Rigid max (IEC)	mm <sup>2</sup>	35
Weight	g	266

#### Relay output for remote status indication

Rated current at	125V AC	A	1
	250V AC	A	1
	12V DC	A	0.5
	24V DC	A	0.5
	48V DC	A	0.5

#### Dimensions

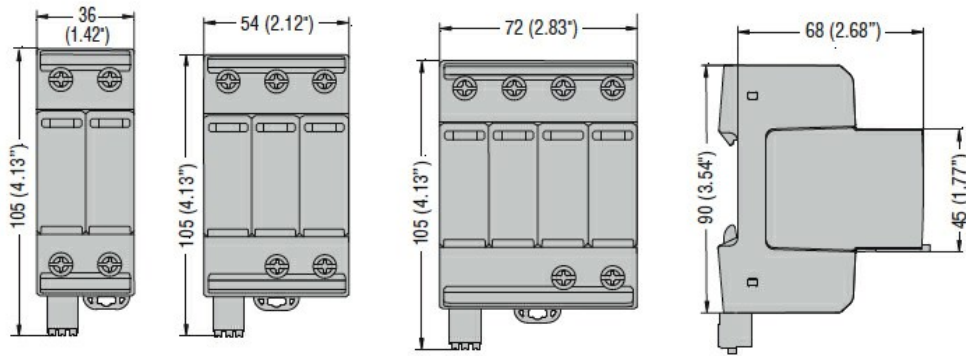

### Wiring diagrams

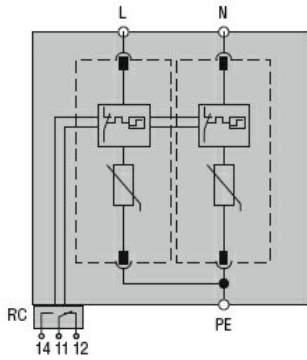

### Certifications and compliance

#### Compliance

IEC/EN 61643-11

#### Certificates

EAC

### ETIM classification

ETIM 8.0

EC000941 -  
Surge protection  
device for power  
supply systems