



# M40S-034502AU0

M4000 Standard

**SAFETY MULTIBEAM SENSORS**

**SICK**  
Sensor Intelligence.



Illustration may differ



### Ordering information

Scanning range	Number of beams	Beam separation	System part	Type	Part no.
0.5 m ... 70 m, configurable	3	450 mm	Sender	M40S-034502AU0	1200085

Other models and accessories → [www.sick.com/M4000\\_Standard](http://www.sick.com/M4000_Standard)

### Detailed technical data

#### Features

<b>Scanning range</b>	0.5 m ... 70 m, configurable
<b>Low scanning range</b>	0.5 m ... 20 m
<b>Great scanning range</b>	9 m ... 70 m
<b>Number of beams</b>	3
<b>Beam separation</b>	450 mm
<b>Response time</b>	10 ms
<b>Synchronization</b>	Optical synchronisation
<b>Specialty</b>	Actuator Sensor Interface replaces the system connection

#### Safety-related parameters

<b>Type</b>	Type 4 (IEC 61496-1)
<b>Safety integrity level</b>	SIL 3 (IEC 61508)
<b>Category</b>	Category 4 (EN ISO 13849)
<b>Performance level</b>	PL e (EN ISO 13849)
<b>PFH<sub>D</sub> (mean probability of a dangerous failure per hour)</b>	$6.6 \times 10^{-9}$ (EN ISO 13849)
<b>T<sub>M</sub> (mission time)</b>	20 years (EN ISO 13849)
<b>Safe state in the event of a fault</b>	At least one OSSD is in the OFF state.

#### Functions

	Functions	Delivery status
<b>Beam coding</b>	✓	Uncoded
<b>Configurable scanning range</b>	✓	

#### Interfaces

<b>Actuator Sensor Interface</b>	✓
<b>System connection</b>	Male connector M12, 4-pin

<sup>1)</sup> Depending on load, power supply and wire cross-section. The technical specifications must be observed.

Permitted cable length	15 m <sup>1)</sup>
Permitted cross-section	≥ 0.25 mm <sup>2</sup>
<b>Configuration method</b>	Configuration buttons
<b>Display elements</b>	LEDs 7-segment display

<sup>1)</sup> Depending on load, power supply and wire cross-section. The technical specifications must be observed.

### Electrical data

<b>Protection class</b>	III (IEC 61140)
<b>Supply voltage V<sub>S</sub></b>	24 V DC (19.2 V DC ... 28.8 V DC) <sup>1)</sup>
<b>Residual ripple</b>	≤ 10 % <sup>2)</sup>
<b>Power consumption</b>	≤ 0.2 A

<sup>1)</sup> The external voltage supply must be capable of buffering brief mains voltage failures of 20 ms as specified in EN 60204-1. Suitable power supplies are available as accessories from SICK.

<sup>2)</sup> Within the limits of V<sub>S</sub>.

### Mechanical data

<b>Dimensions</b>	See dimensional drawing
<b>Housing cross-section</b>	52 mm x 55.5 mm
<b>Material</b>	
Housing	Aluminum alloy ALMGSI 0.5, powder coated
Front screen	Polycarbonate, scratch-resistant coating

### Ambient data

<b>Enclosure rating</b>	IP65 (EN 60529)
<b>Ambient operating temperature</b>	-30 °C ... +55 °C
<b>Storage temperature</b>	-30 °C ... +70 °C
<b>Air humidity</b>	15 % ... 95 %, Non-condensing
<b>Shock resistance</b>	10 g, 16 ms (IEC 60068-2-29)

### Other information

<b>Wave length</b>	850 nm
--------------------	--------

### Classifications

<b>eCl@ss 5.0</b>	27272703
<b>eCl@ss 5.1.4</b>	27272703
<b>eCl@ss 6.0</b>	27272703
<b>eCl@ss 6.2</b>	27272703
<b>eCl@ss 7.0</b>	27272703
<b>eCl@ss 8.0</b>	27272703
<b>eCl@ss 8.1</b>	27272703
<b>eCl@ss 9.0</b>	27272703
<b>eCl@ss 10.0</b>	27272703
<b>eCl@ss 11.0</b>	27272703
<b>eCl@ss 12.0</b>	27272703
<b>ETIM 5.0</b>	EC001832

# M40S-034502AUO | M4000 Standard

SAFETY MULTIBEAM SENSORS

<b>ETIM 6.0</b>	EC001832
<b>ETIM 7.0</b>	EC001832
<b>ETIM 8.0</b>	EC001832
<b>UNSPSC 16.0901</b>	46171620

Dimensional drawing (Dimensions in mm (inch))

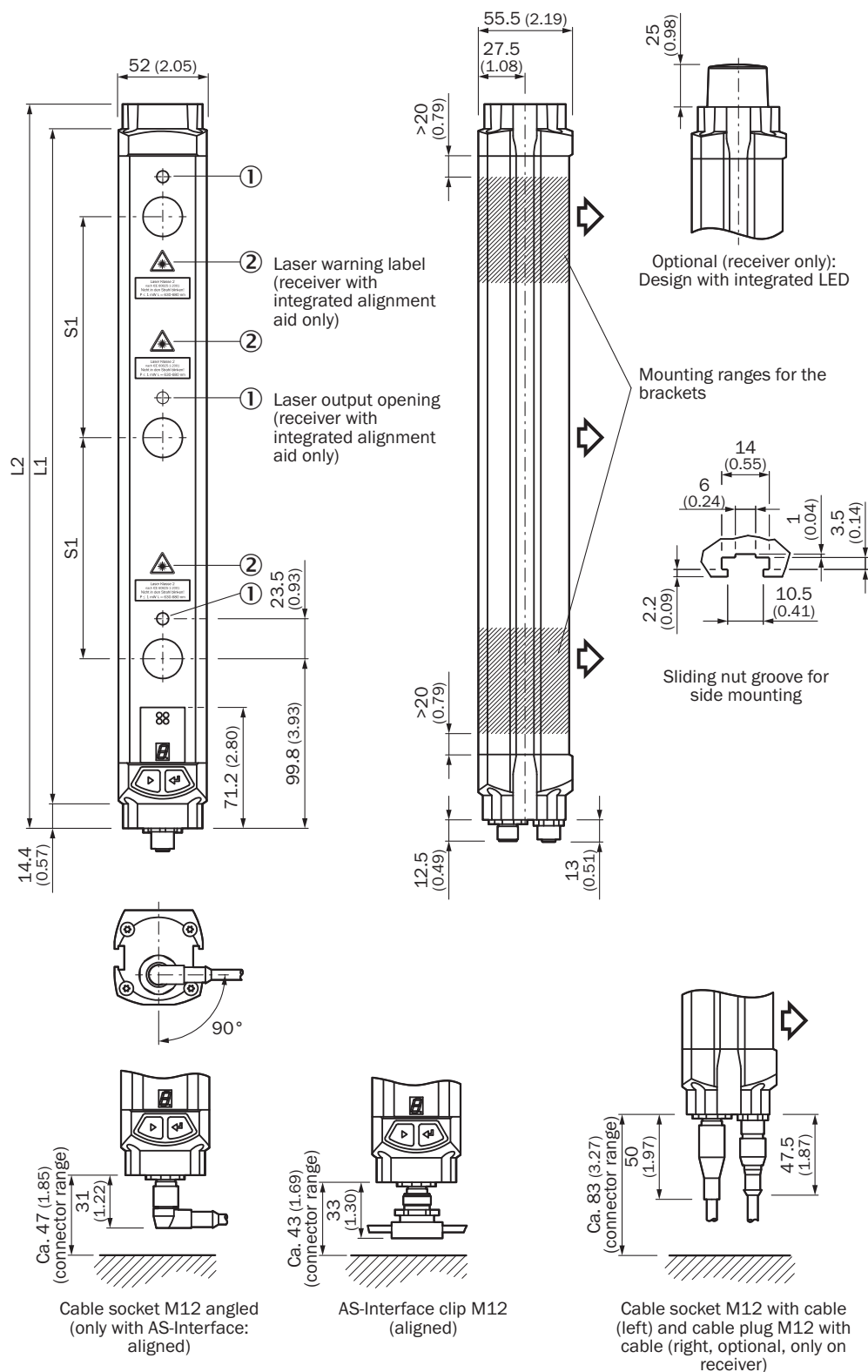

Illustration sender (receiver mirror image)

Number of beams	Beam separation S1	L1	L2
2	500 (19.69)	643 (25.31)	672 (26.46)

Number of beams	Beam separation S1	L1	L2
3	600 (23.62)	743 (29.25)	772 (30.39)
	220 (8.66)	583 (22.95)	612 (24.09)
	400 (15.75)	943 (37.13)	972 (38.27)
4	450 (17.72)	1,043 (41.06)	1,072 (42.20)
	220 (8.66)	803 (31.61)	832 (32.76)
	300 (11.81)	1,043 (41.06)	1,072 (42.20)
5	220 (8.66)	1,023 (40.28)	1,052 (41.42)
6		1,243 (48.94)	1,272 (50.08)
7		1,462 (57.56)	1,491 (58.70)
8		1,682 (66.22)	1,711 (67.36)

### Recommended accessories

Other models and accessories → [www.sick.com/M4000\\_Standard](http://www.sick.com/M4000_Standard)

	Brief description	Type	Part no.
<b>Alignment aids</b>			
	Laser alignment aid for various sensors, laser class 2 (IEC 60825). Do not look into the beam!, 19 mm x 67.3 mm x 66.9 mm	AR60	1015741
	Adapter AR60 for M4000 and M4000 Curtain	AR60 adapter, M4000	4040006
<b>Mounting brackets and plates</b>			
	4 pieces, Mounting kit 1, mounting bracket, rigid, L-shaped, including fixing screws and washers	BEF-3WNGBAST4	7021352
<b>Terminal and alignment brackets</b>			
	4 pieces, Mounting kit 6, side bracket, rotatable, zinc diecast	BEF-1SHABAZN4	2019506
	4 pieces, Mounting kit 12, rotatable, swivel mount	BEF-2SMGEAKU4	2030510

## SICK AT A GLANCE

SICK is one of the leading manufacturers of intelligent sensors and sensor solutions for industrial applications. A unique range of products and services creates the perfect basis for controlling processes securely and efficiently, protecting individuals from accidents and preventing damage to the environment.

We have extensive experience in a wide range of industries and understand their processes and requirements. With intelligent sensors, we can deliver exactly what our customers need. In application centers in Europe, Asia and North America, system solutions are tested and optimized in accordance with customer specifications. All this makes us a reliable supplier and development partner.

Comprehensive services complete our offering: SICK LifeTime Services provide support throughout the machine life cycle and ensure safety and productivity.

For us, that is “Sensor Intelligence.”

## WORLDWIDE PRESENCE:

Contacts and other locations –[www.sick.com](http://www.sick.com)