

FuPact ISFL1250

Switch-Disconnecter Fuses
 Interrupteur-Sectionneur à Fusibles
 Interruptor-fusibles
 开关切断器保险丝
 Sicherungslasttrennschalter
 Fusibili interruttore-sezionatore
 Fusíveis do desconector do interruptor
 Предохранители выключателей-разъединителей

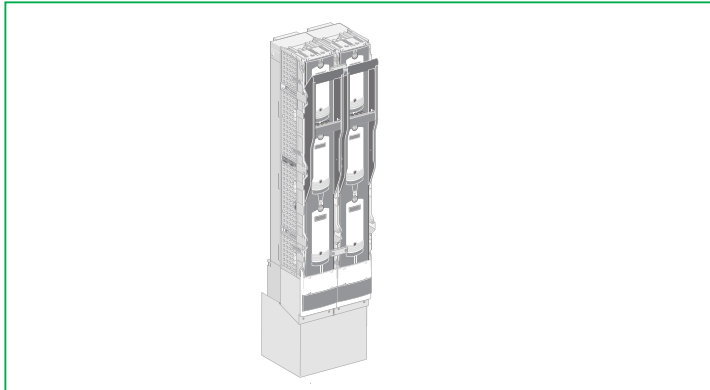

HRB3824301



HRB3824301-03

<p>PLEASE NOTE Electrical equipment should be installed, operated, serviced, and maintained only by qualified personnel. No responsibility is assumed by Schneider Electric for any consequences arising out of the use of this material.</p>	<p>REMARQUE IMPORTANTE L'installation, l'utilisation, la réparation et la maintenance des équipements électriques doivent être assurées uniquement par du personnel qualifié. Schneider Electric décline toute responsabilité quant aux conséquences de l'utilisation de ce matériel.</p>
<p>TENGA EN CUENTA La instalación, manejo, puesta en servicio y mantenimiento de equipos eléctricos deberán ser realizados sólo por personal cualificado. Schneider Electric no se hace responsable de ninguna de las consecuencias del uso de este material.</p>	<p>请注意 电气设备的安装、操作、维修和维护工作仅限于合格人员执行。Schneider Electric不承担由于使用本资料所引起的任何后果。</p>
<p>BITTE BEACHTEN Elektrische Geräte dürfen nur von Fachpersonal installiert, betrieben, bedient und gewartet werden. Schneider Electric haftet nicht für Schäden, die durch die Verwendung dieses Materials entstehen.</p>	<p>NOTA Manutenzione, riparazione, installazione e uso delle apparecchiature elettriche si devono affidare solo a personale qualificato. Schneider Electric non si assume alcuna responsabilità per qualsiasi conseguenza derivante dall'uso di questo materiale.</p>
<p>NOTA A instalação, utilização e manutenção do equipamento eléctrico devem ser efectuadas exclusivamente por pessoal qualificado. A Schneider Electric não assume qualquer responsabilidade pelas consequências resultantes da utilização deste material.</p>	<p>ОБРАТИТЕ ВНИМАНИЕ Установка, эксплуатация, ремонт и обслуживание электрического оборудования может выполняться только квалифицированными электриками. Компания Schneider Electric не несет никакой ответственности за любые возможные последствия использования данной документации.</p>

⚠️ DANGER / DANGER / PELIGRO / 危險 / GEFAHR / PERICOLO / PERIGO / ОПАСНОСТЬ

<p>HAZARD OF ELECTRIC SHOCK, EXPLOSION OR ARC FLASH ■ Apply appropriate personal protective equipment (PPE) and follow safe electrical work practices. See NFPA 70E, CSA Z462 or local equivalent. ■ This equipment must only be installed and serviced by qualified electrical personnel. ■ Turn off all power supplying this equipment before working on or inside equipment. Lock the switchgear in the isolated position. ■ Always use a properly rated voltage sensing device to confirm power is off. ■ Install safety barriers and display a danger sign. ■ Replace all devices, doors, and covers before turning on power to this equipment. Failure to follow these instructions will result in death or serious injury.</p>	<p>RISQUE D'ÉLECTROCUTION, D'EXPLOSION OU D'ECLAIR D'ARC ELECTRIQUE ■ Portez un équipement de protection personnelle adapté et respectez les consignes de sécurité électrique courantes. Reportez-vous aux normes NFPA 70E, CSA Z462 ou aux textes équivalents applicables dans votre région du monde. ■ Seul un personnel qualifié doit effectuer l'installation et l'entretien de cet appareil. ■ Débranchez toutes les sources d'alimentation de cet équipement avant d'effectuer toute opération interne ou externe sur celui-ci. Verrouillez l'appareillage en position isolée. ■ Utilisez toujours un dispositif de détection de tension ayant une valeur nominale appropriée pour vous assurer que l'alimentation est coupée ■ Installez des barrières de sécurité et affichez un signal de danger. ■ Remettez en place tous les équipements, les portes et les capots avant de remettre l'appareil sous tension. Si ces directives ne sont pas respectées, cela entraînera la mort ou des blessures graves.</p>	<p>PELIGRO DE DESCARGA ELÉCTRICA, EXPLOSIÓN O ARCO ELÉCTRICO ■ Utilice el equipo de protección personal (PPE) adecuado y siga las recomendaciones para el trabajo seguro con dispositivos eléctricos. Consulte NFPA 70E, CSA Z462 o la norma local equivalente. ■ Solo el personal de electricidad cualificado podrá instalar, programar y realizar el mantenimiento del equipo. ■ Desconecte toda la alimentación de este equipo antes de trabajar en él o en su interior. Bloquee la aparamenta eléctrica en la posición de aislamiento. ■ Utilice siempre un dispositivo de detección de tensión de capacidad adecuada para confirmar la ausencia de alimentación eléctrica. ■ Instale barreras de seguridad y coloque un cartel de peligro. ■ Vuelva a colocar todos los dispositivos, las puertas y las tapas antes de conectar la alimentación de este equipo. El incumplimiento de estas instrucciones podrá causar la muerte o lesiones serias.</p>	<p>电击、爆炸或电弧闪光危险 ■ 采用适当的个人防护设备 (PPE) 并遵循电气作业安全守则。请参阅 NFPA 70E, CSA Z462 或当地对应的标准。 ■ 只有具备相应资质的电气人员才能安装和维修该设备。 ■ 在该设备表面或内部工作之前, 请关闭设备的全部电源。将开关锁定在隔离位置。 ■ 确保使用合适的额定电压传感器确认电源已关闭。 ■ 安装安全栅并显示危险标志。 ■ 更换所有设备、门和盖, 然后再打开该设备的电源。 不遵循上述说明将导致人员伤亡。</p>
<p>GEFAHR VON ELEKTRISCHEM SCHLAG, EXPLOSION ODER LICHTBOGEN ■ Tragen Sie persönliche Schutzausrüstung (PSA) und befolgen Sie sichere Verfahren im Umgang mit Elektrogeräten. Siehe NFPA 70E, CSA Z462 oder lokale Entsprechung. ■ Diese Geräte dürfen nur von qualifizierten Elektrikern installiert und gewartet werden. ■ Schalten Sie vor Arbeiten am bzw. im Innern des Geräts die gesamte Spannungsversorgung ab. Die Schaltanlage in die Trennstellung bringen. ■ Verwenden Sie für die Prüfung vorhandener Spannung stets einen Spannungsfühler mit zutreffender Bemessungsspannung. ■ Bringen Sie Sicherheitsbarrieren und einen Warnhinweis an. ■ Bringen Sie alle Vorrichtungen, Türen und Abdeckungen wieder an, bevor Sie das Gerät einschalten. Die Nichtbeachtung dieser Anweisungen führt zu Tod oder schweren Verletzungen.</p>	<p>RISCHIO DI FOLGORAZIONE, ESPLOSIONE O BAGLIORI DA ARCO ■ Utilizzare dispositivi di protezione individuale (DPI) idonei e adottare misure di sicurezza adeguate per lavori elettrici. Vedere le normative NFPA 70E, CSA Z462 o le norme equivalenti nel paese di installazione. ■ Installazione e manutenzione di questa apparecchiatura si devono affidare solo ad elettricisti qualificati. ■ Prima di lavorare con l'apparecchiatura o al suo interno isolare completamente l'alimentazione elettrica. Bloccare l'interruttore in posizione isolata. ■ Per verificare che l'alimentazione sia isolata usare sempre un rivelatore di tensione correttamente tarato. ■ Installare barriere di sicurezza e apporre un segnale di pericolo. ■ Sostituire dispositivi, sportelli e coperture prima di riaccendere l'alimentazione dell'apparecchiatura. Il mancato rispetto di queste istruzioni provocherà morte o gravi infortuni.</p>	<p>PERIGO DE CHOQUE ELÉCTRICO, EXPLOSIÃO OU ARCO ELÉCTRICO ■ Instale equipamento de protecção pessoal (PPE) e siga os métodos de segurança eléctrica. Consulte NFPA 70E, CSA Z462 ou o equivalente local. ■ A instalação e manutenção deste equipamento só devem ser efectuadas por electricistas qualificados. ■ Desligue todas as fontes de alimentação deste equipamento antes de trabalhar no equipamento ou no seu interior. Bloquee a placa de distribuição na posição isolada ■ Utilize sempre um dispositivo de detecção da tensão nominal adequada para confirmar se a alimentação está desligada. ■ Instale barreiras de segurança e apresente um sinal de perigo. ■ Substitua todos os dispositivos, portas e tapas antes de ligar a alimentação deste equipamento. A não observância destas instruções resultará em morte, ou ferimentos graves.</p>	<p>Опасность поражения электрическим током, взрыва или возникновения дуги ■ Используйте подходящие средства индивидуальной защиты (СИЗ) и соблюдайте технику безопасности при электротехнических работах. См. NFPA 70E, CSA Z462 или местный эквивалентный стандарт. ■ Данное оборудование могут устанавливать и обслуживать только квалифицированные электрики. ■ Отключите питание до начала работы снаружи или внутри оборудования. ■ Всегда пользуйтесь надлежащим датчиком номинального напряжения для определения отсутствия питания. ■ Установите защитные ограждения и знак опасности. ■ Установите обратно все устройства, дверцы и крышки перед включением питания данного оборудования. Несоблюдение этих инструкций приведет к смерти или серьезной травме.</p>

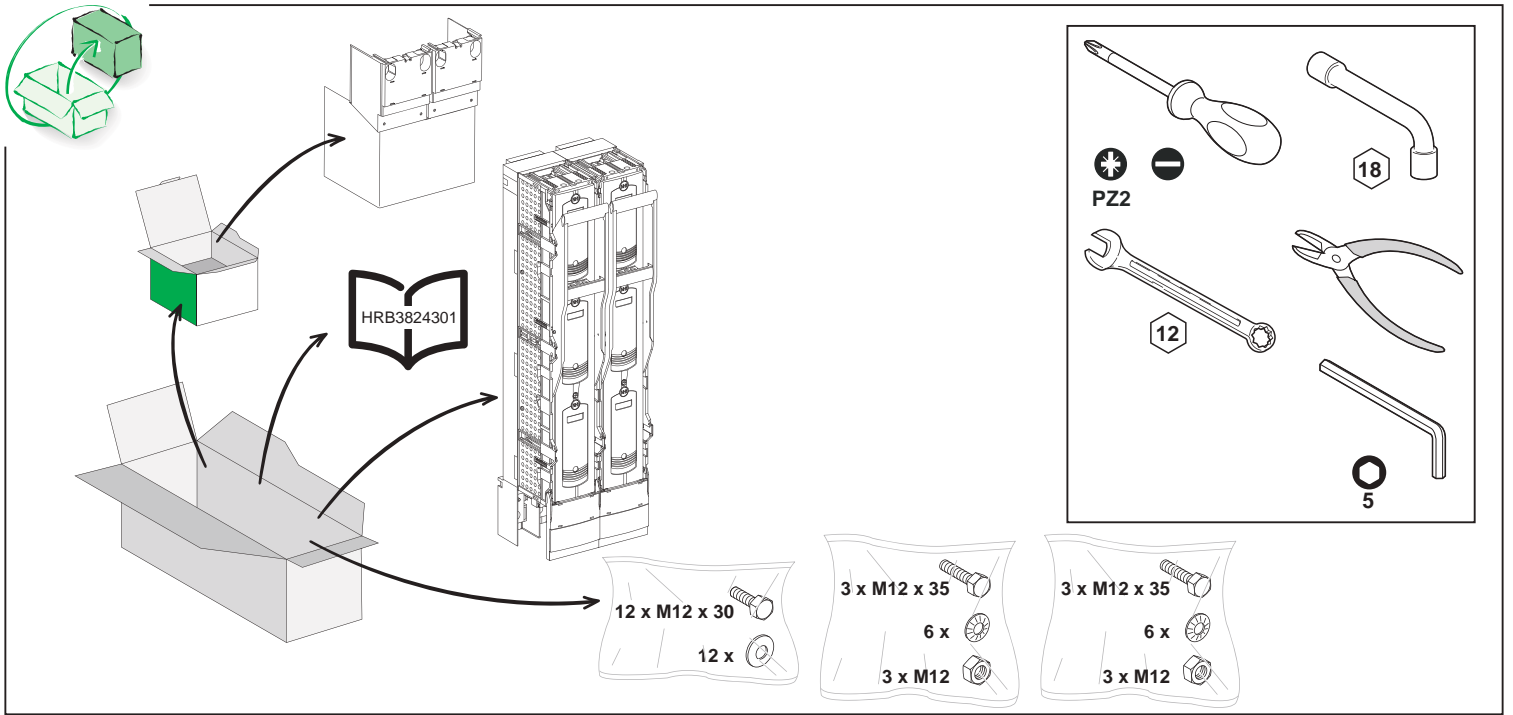

<p>The product's manufacture date is coded PP-YYYY-Www-D, where:</p> <ul style="list-style-type: none"> ● PP: plant code ● YYYY: year of manufacture ● Www: week of manufacture ● D: weekday of manufacture (Monday = 1) <p>Eg: 7Q-2014-W19-3 = product manufactured at plant 7Q on Wednesday 7 May 2014</p>	<p>La date de fabrication du produit est codée PP-YYYY-Www-D, avec:</p> <ul style="list-style-type: none"> ● PP: code usine ● YYYY: année de fabrication ● Www: semaine de fabrication ● D: jour de fabrication dans la semaine (lundi = 1) <p>Ex: 7Q-2014-W19-3= produit fabriqué le mercredi 7 mai 2014 par l'usine 7Q.</p>	<p>La fecha de fabricación del producto está codificada PP-YYYY-Www-D, donde:</p> <ul style="list-style-type: none"> ● PP: código de la planta ● YYYY: año de fabricación ● Www: semana de fabricación ● D: día de la semana de fabricación (lunes = 1) <p>Ej: 7Q-2014-W19-3 = producto fabricado en la planta 7Q el miércoles 7 de mayo de 2014</p>	<p>产品制造日期采用如下代码 PP-YYYY-Www-D, 其中:</p> <ul style="list-style-type: none"> ● PP: 工厂代码 ● YYYY: 制造年份 ● Www: 第几周制造 ● D: 星期几制造 (星期一 = 1) <p>例如: 7Q-2014-W19-3 = 产品于 2014 年 5 月 7 日星期三 在 7Q 工厂制造。</p>
<p>Das Herstellungsdatum des Produkts ist folgendermaßen codiert: PP-YYYY-Www-D, wobei:</p> <ul style="list-style-type: none"> ● PP: Werkscode ● YYYY: Herstellungsjahr ● Www: Herstellungswoche ● D: Herstellungstag (Montag = 1) <p>Z. B: 7Q-2014-W19-3 = ein Produkt, das in Werk 7Q, am Mittwoch den 7. Mai, im Jahr 2014 gefertigt wurde.</p>	<p>La data di fabbricazione del prodotto è indicata con il codice PP-YYYY-Www-D, dove:</p> <ul style="list-style-type: none"> ● PP: codice stabilimento ● YYYY: anno di fabbricazione ● Www: settimana di fabbricazione ● D: giorno della settimana in cui il prodotto è stato fabbricato (lunedì = 1) <p>Ad es: 7Q-2014-W19-3 = prodotto fabbricato presso lo stabilimento 7Q mercoledì 7 maggio 2014.</p>	<p>A data de fabrico do produto está sob a forma de código PP-YYYY-Www-D, onde:</p> <ul style="list-style-type: none"> ● PP: código da fábrica ● YYYY: ano de fabrico ● Www: semana de fabrico ● D: dia da semana de fabrico (Segunda-feira = 1) <p>Ex: 7Q-2014-W19-3 = produto fabricado na fábrica 7Q na Quarta-feira 7 de Maio de 2014.</p>	<p>Дата производства продукта закодирована в формате PP-YYYY-Www-D, где:</p> <ul style="list-style-type: none"> ● PP: код завода ● YYYY: год производства ● Www: неделя производства ● D: день недели, когда был произведен продукт (понедельник = 1) <p>Пример: 7Q-2014-W19-3 = продукт произведен на заводе 7Q в среду, 7 мая 2014 года.</p>

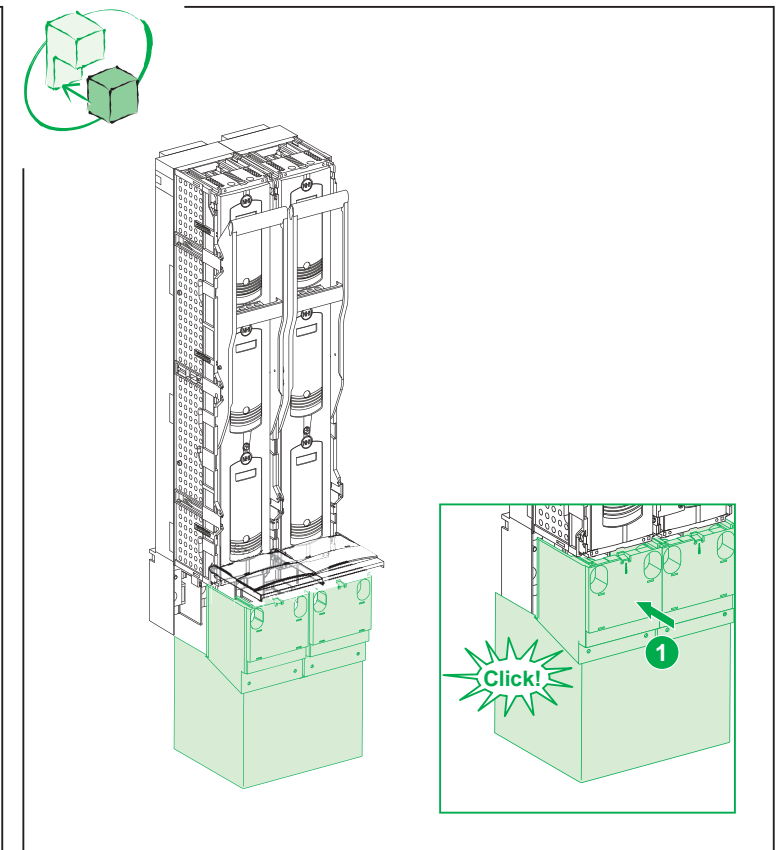
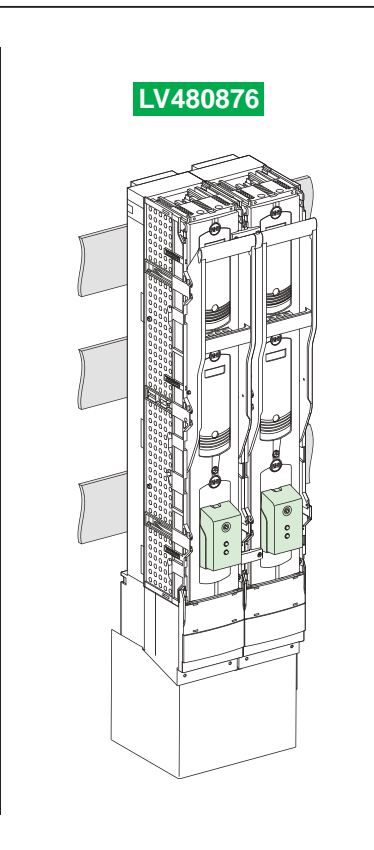
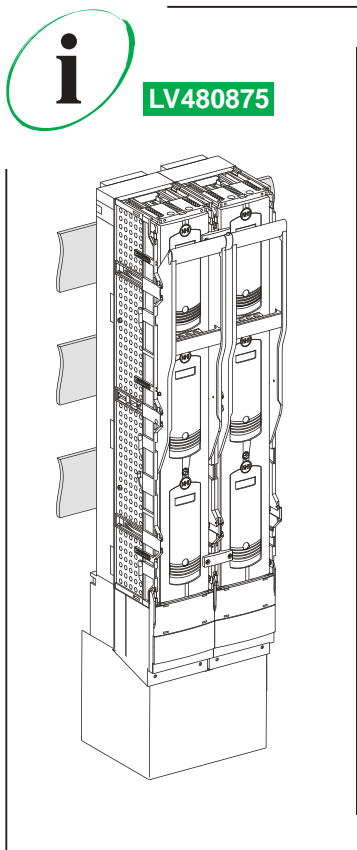

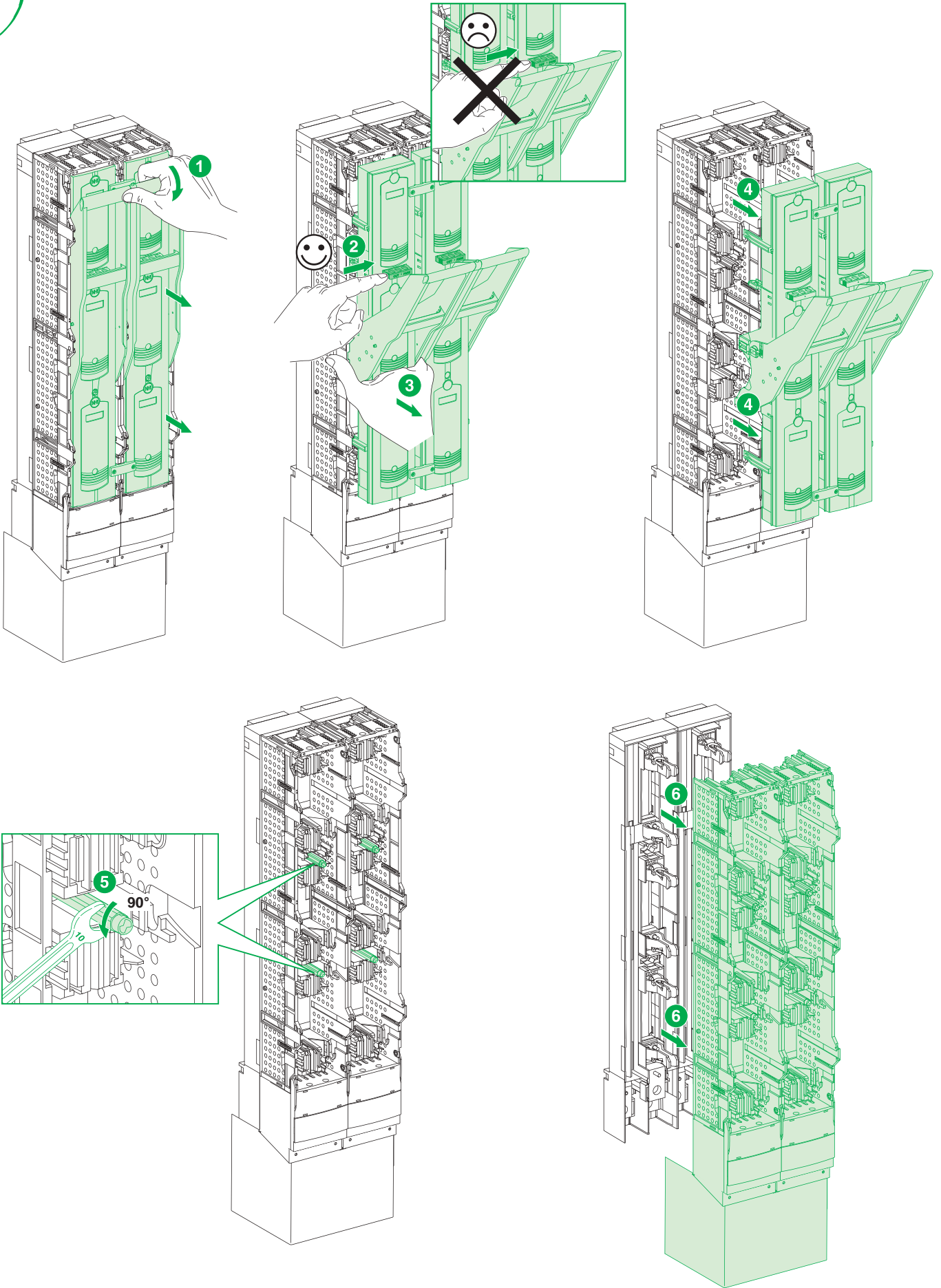

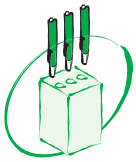

mm
in

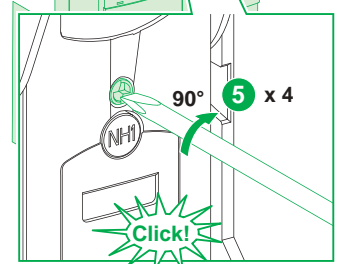
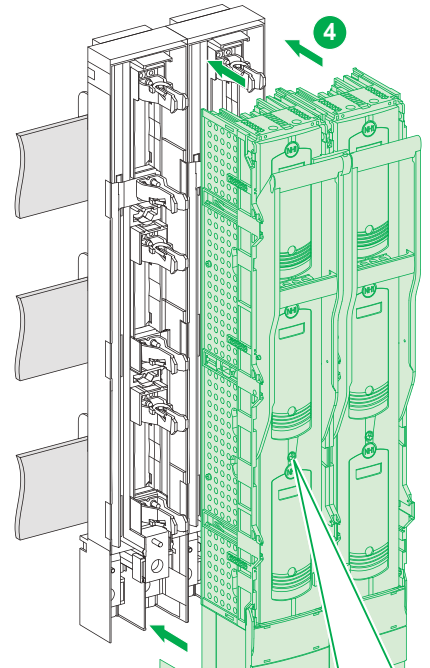
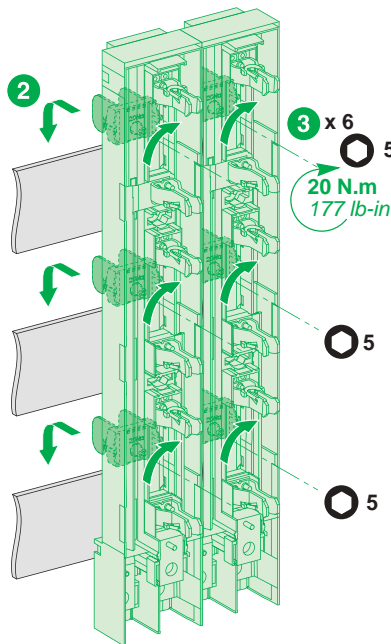
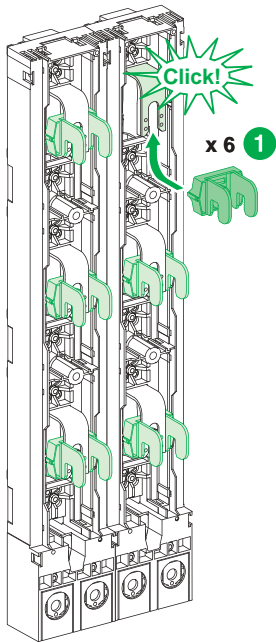
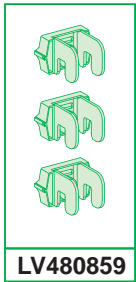
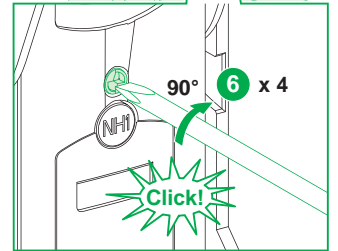
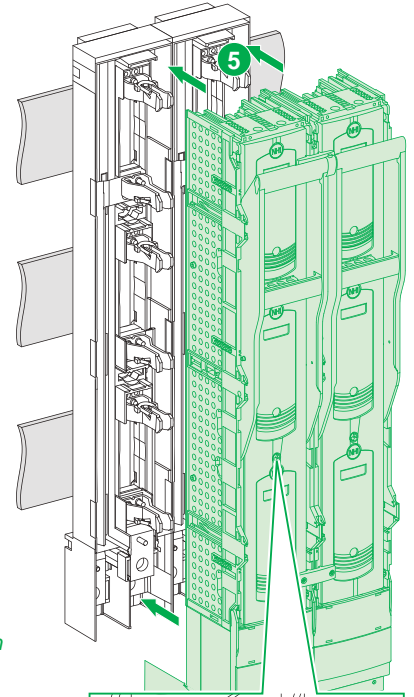
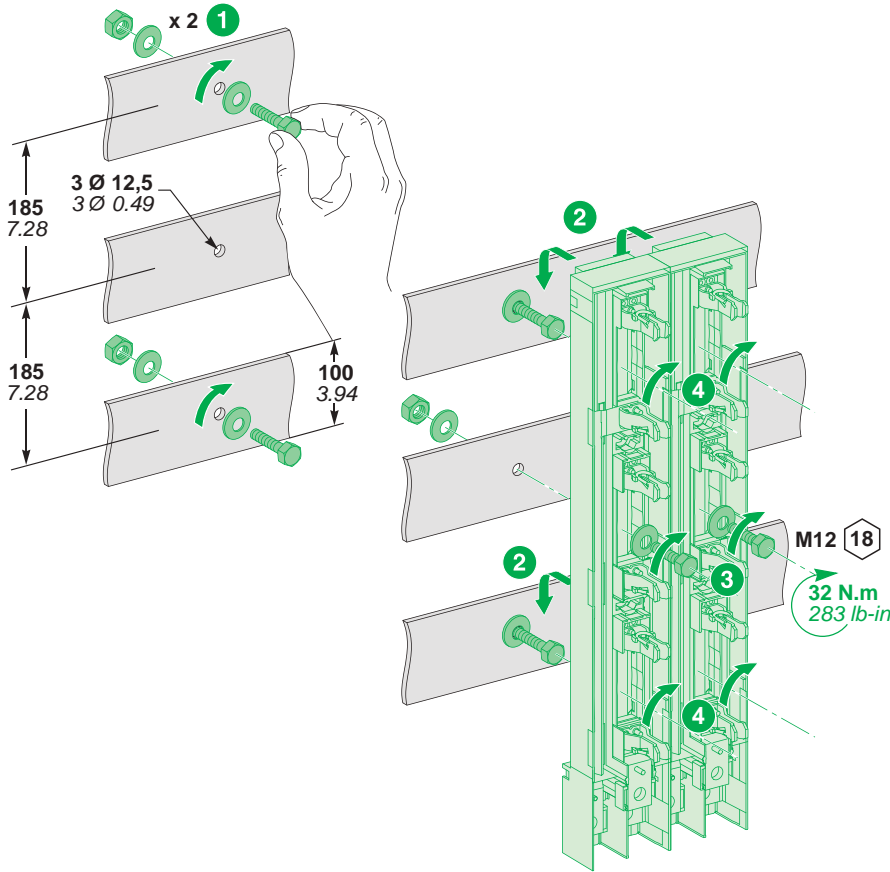

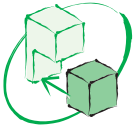

- LV480885
 - LV480886
 - LV480887
 - LV480888
- 
- LV480889

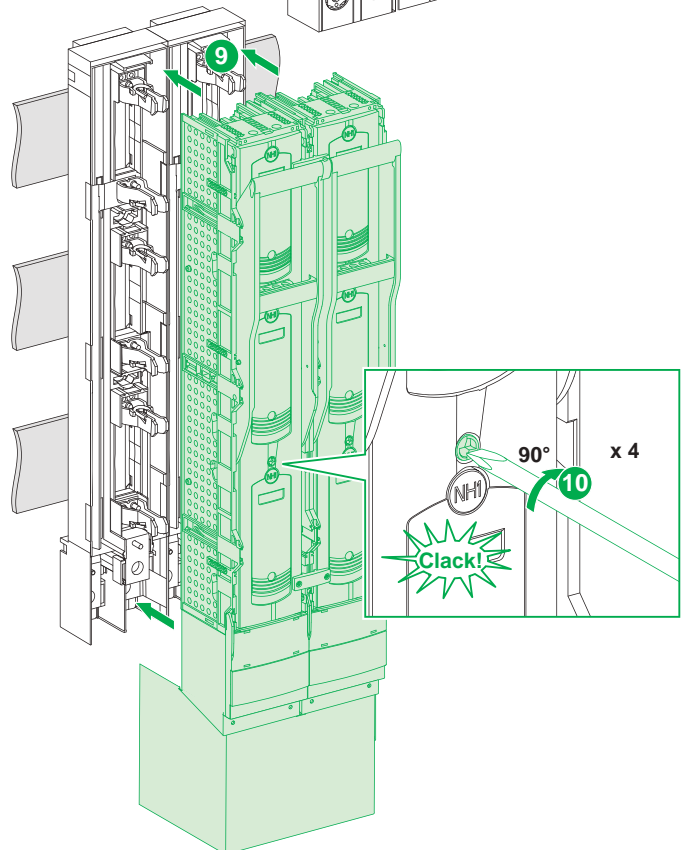
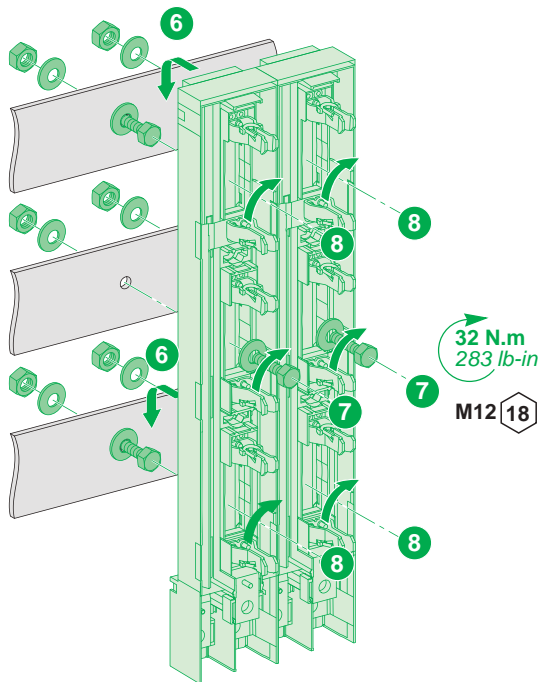
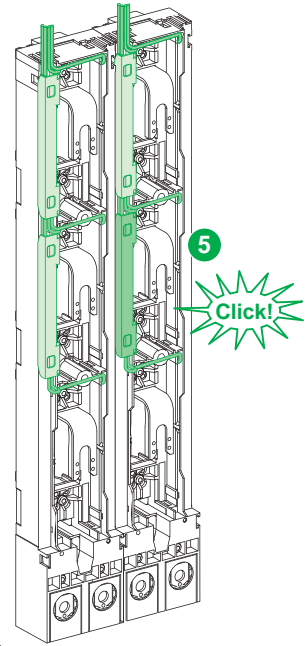
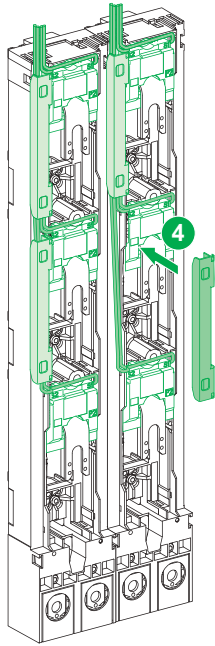
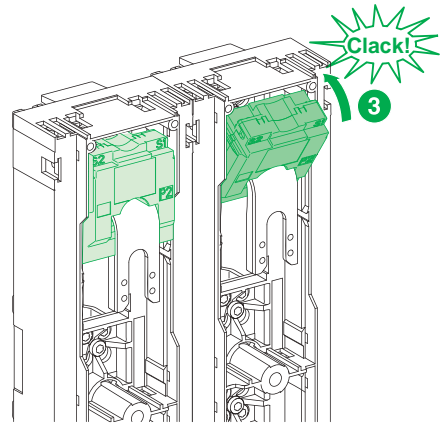
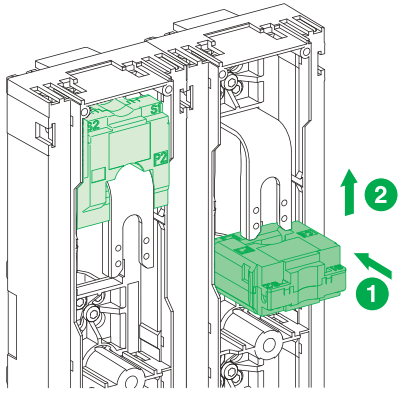

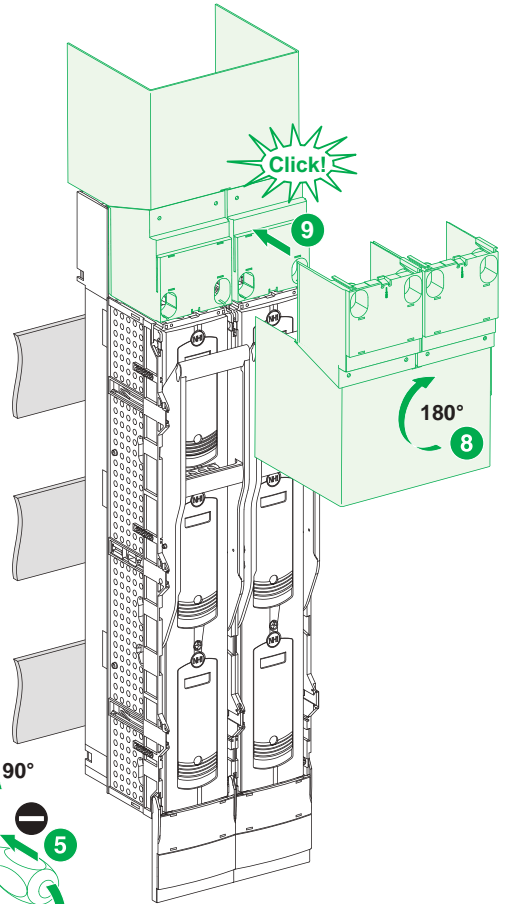
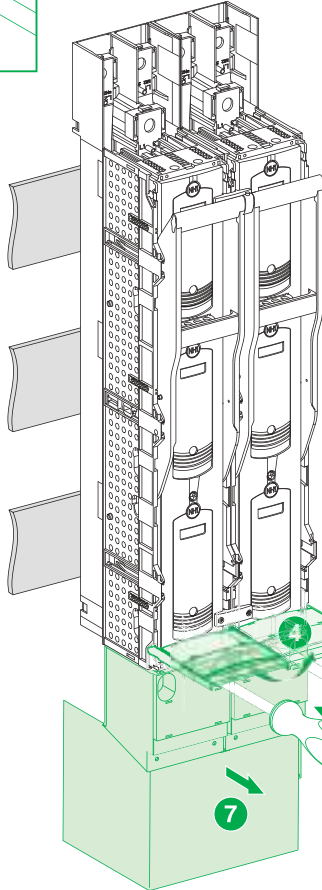
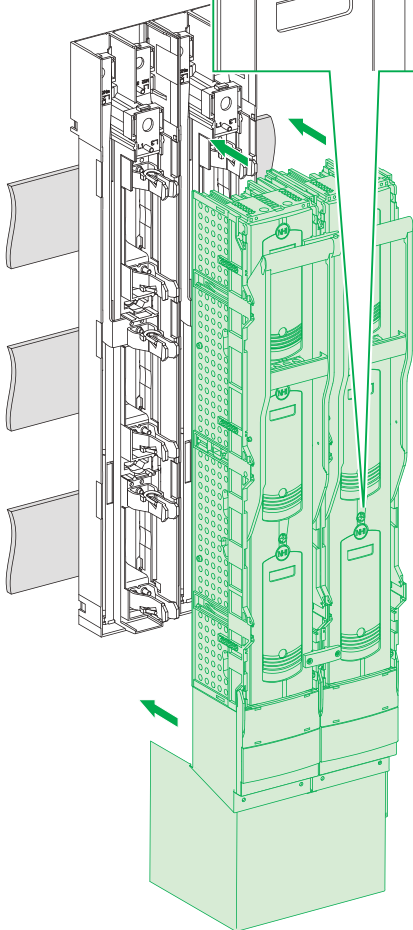
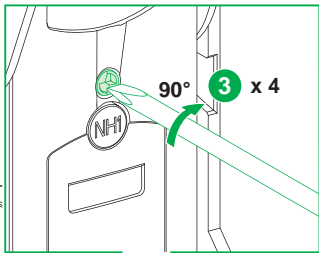
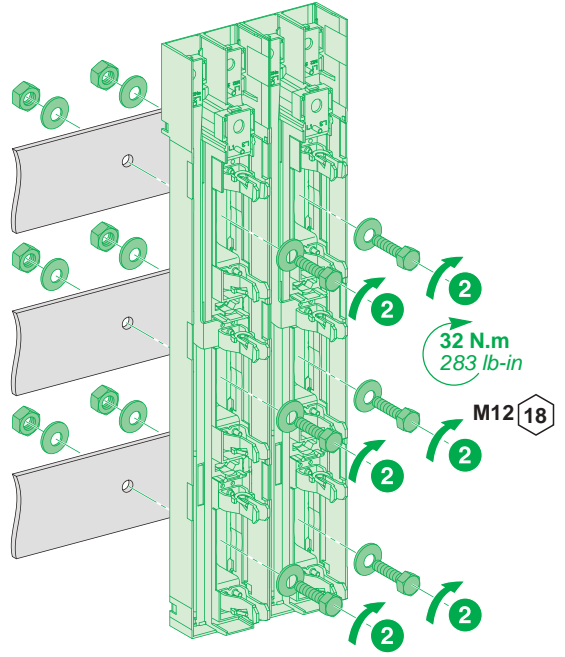
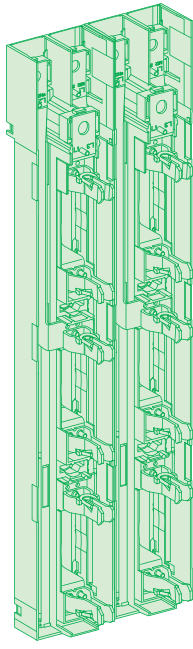
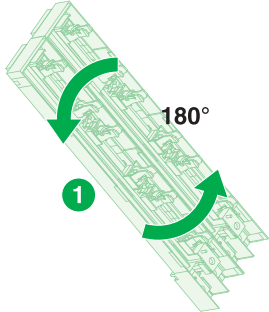
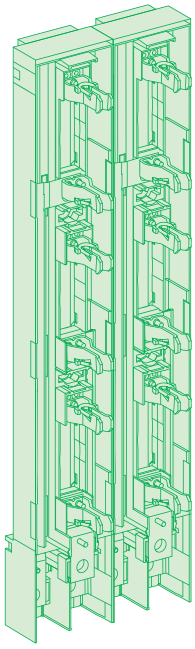
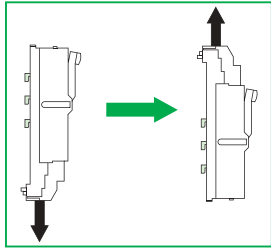
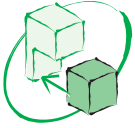

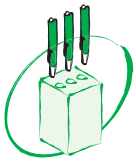

mm
in

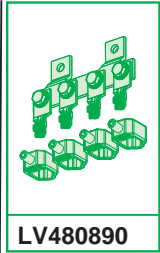
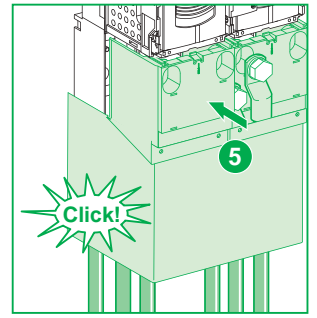
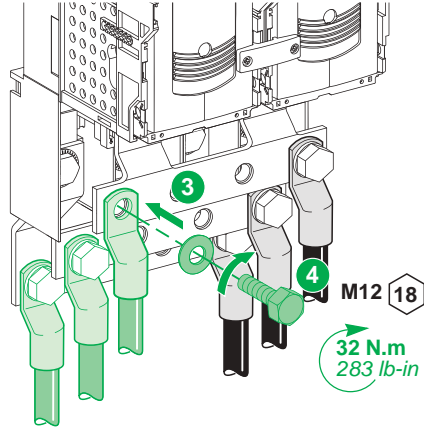
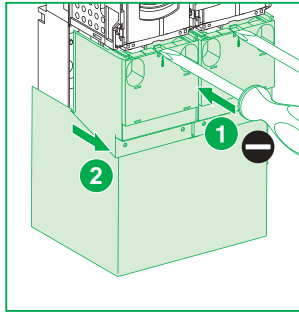
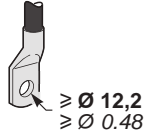

LV480890

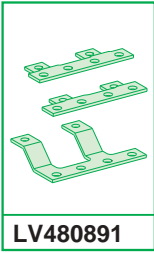

LV480891



PHA33326



QGH4568500

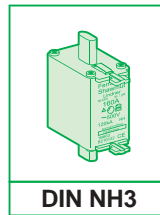
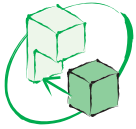

DIN NH3



DOCA0136

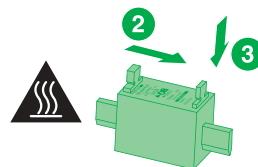
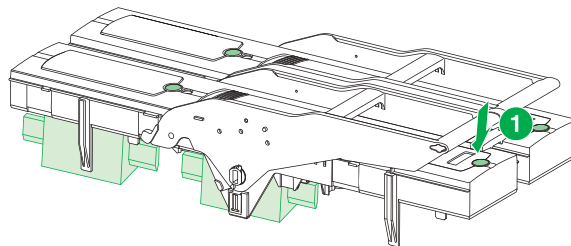
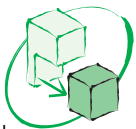
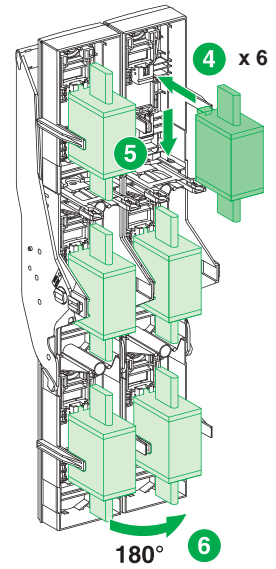
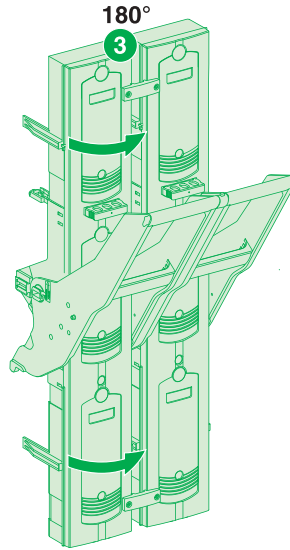
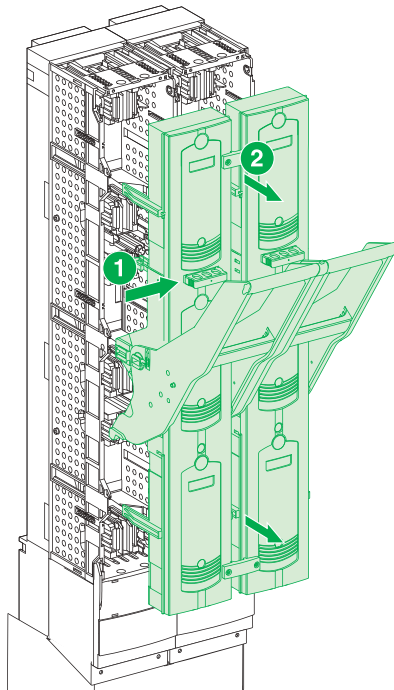

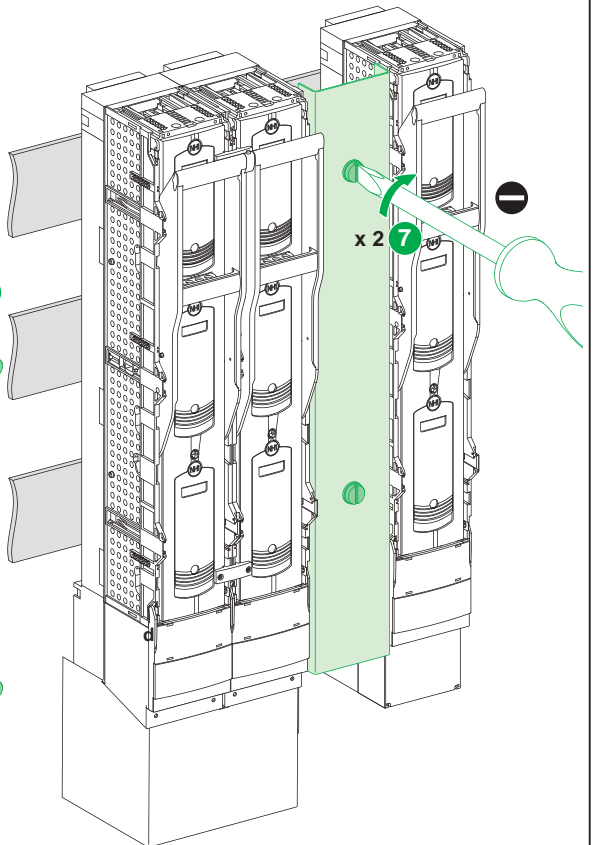
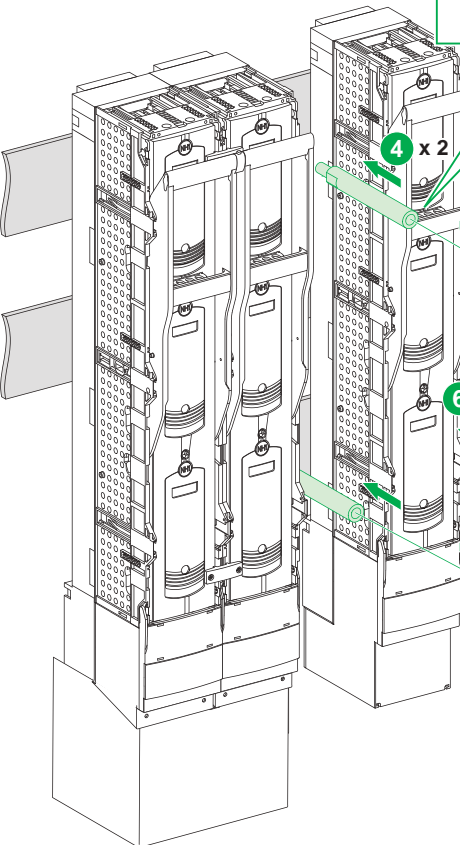
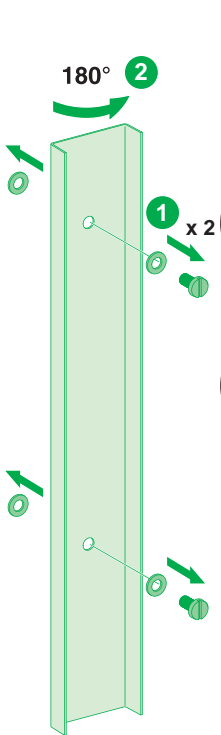
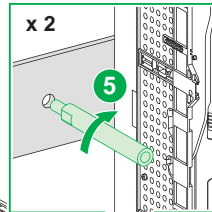
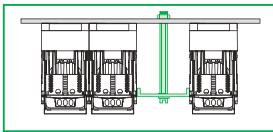
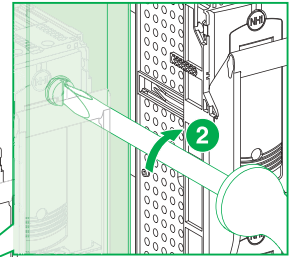
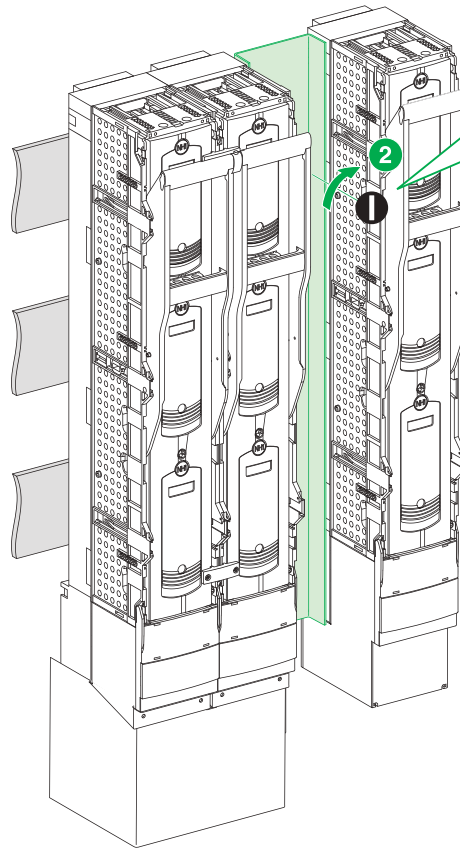
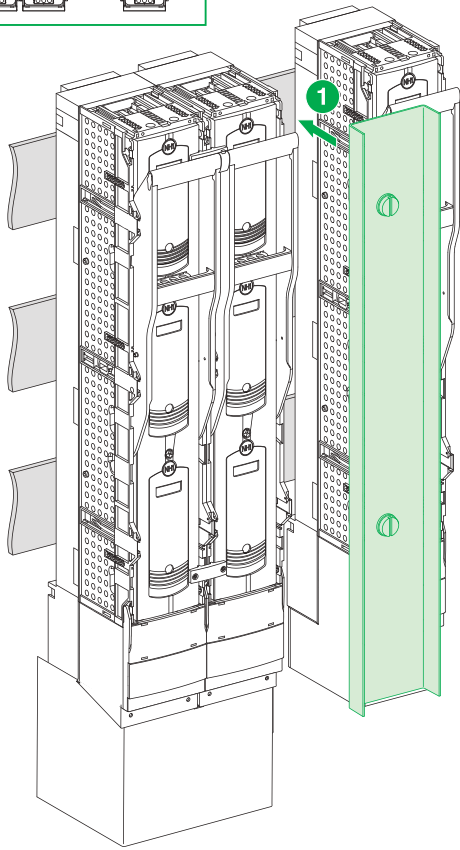
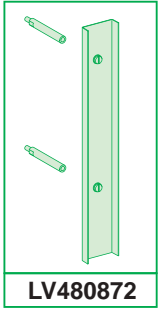
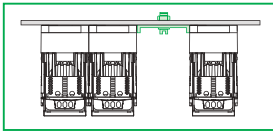
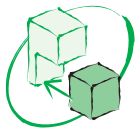

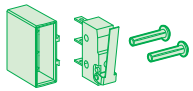
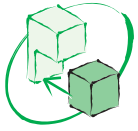

LV480841
联系本地销售。

2.8 x 5 mm
0.11 x 0.2 in.
Not supplied
non fournis
no incluido
未提供
Nicht im Lieferumfang enthalten
Non fornito in dotazione
Não fornecido
Воб'єм поставки не входить

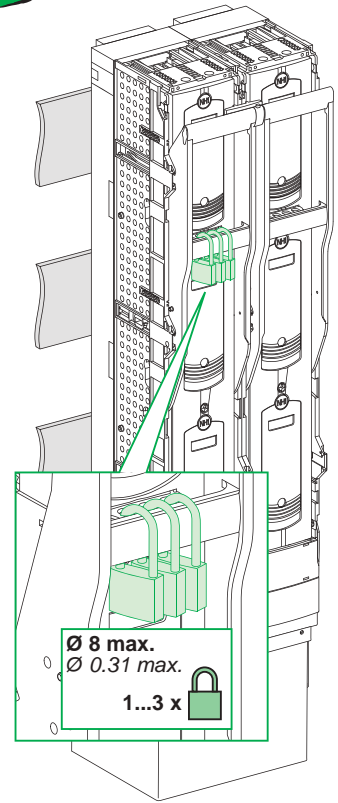
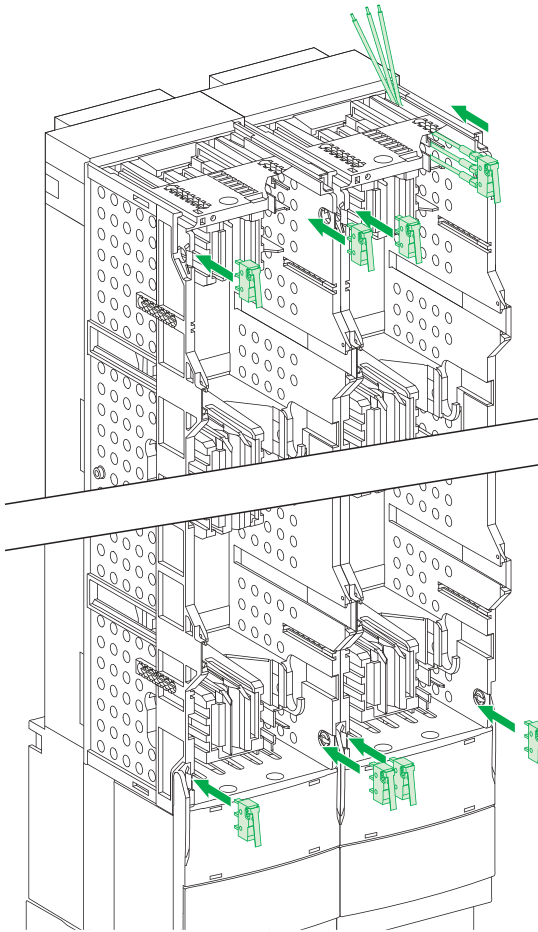
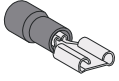

Ø 8 max.
Ø 0.31 max.
1...3 x

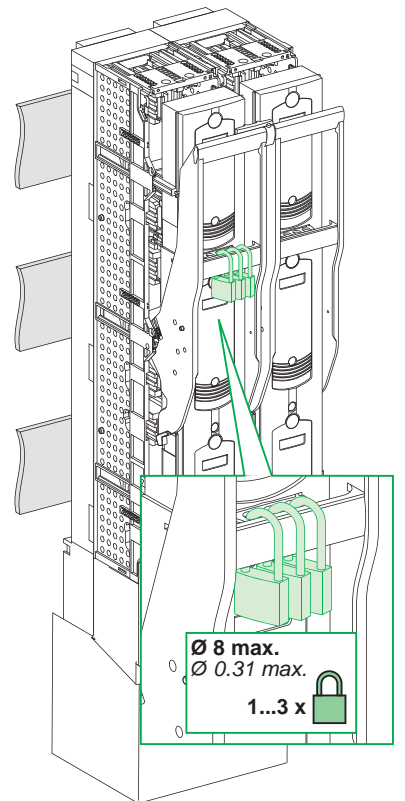
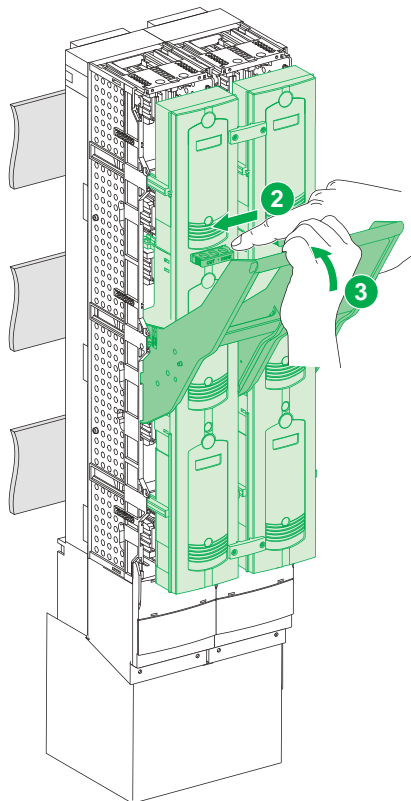
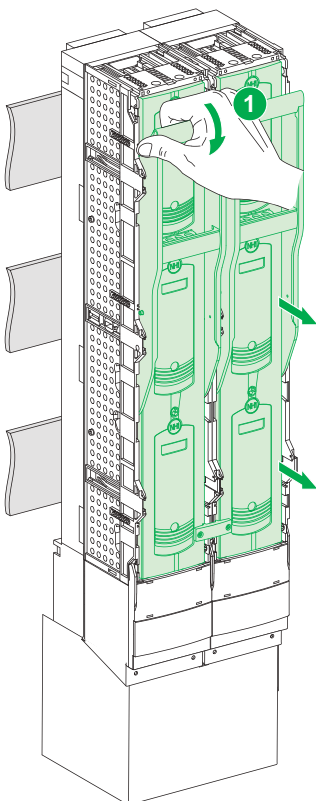

Ø 8 max.
Ø 0.31 max.
1...3 x



LV480869

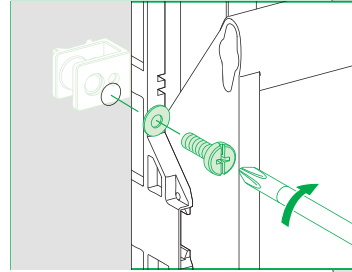
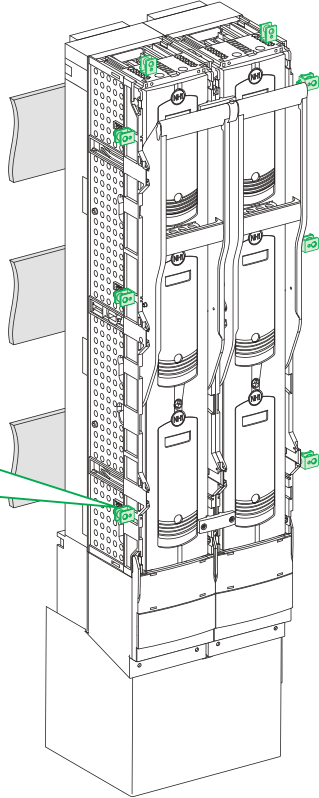
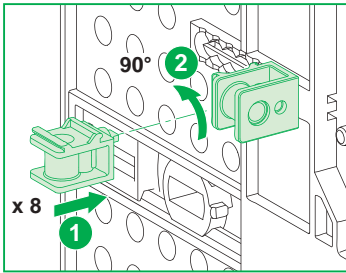
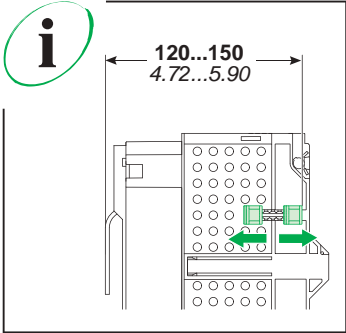

1,5 N.m
13.27 lb-in
PZ3

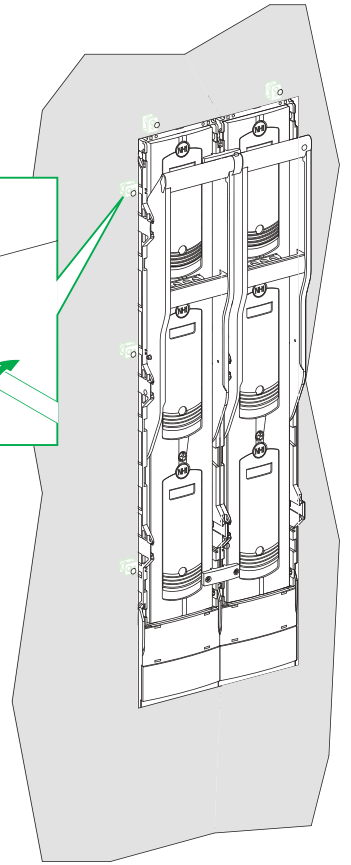

LV480869

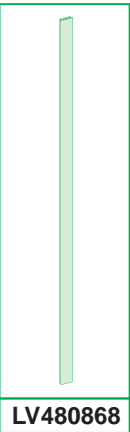

LV480868

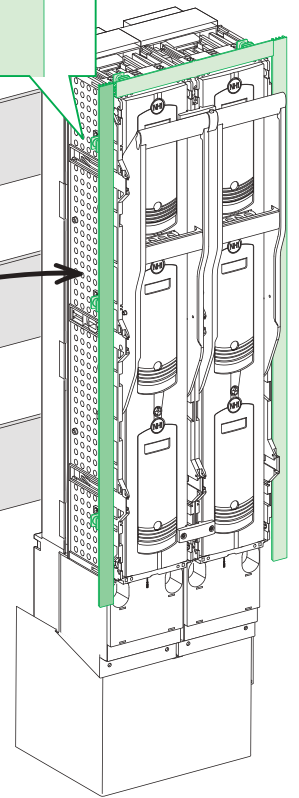
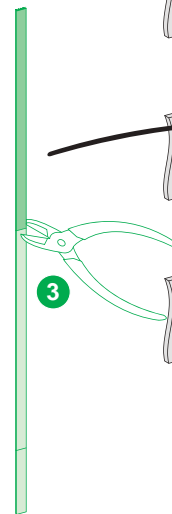
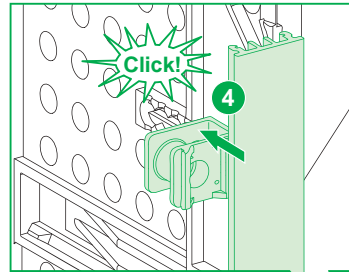
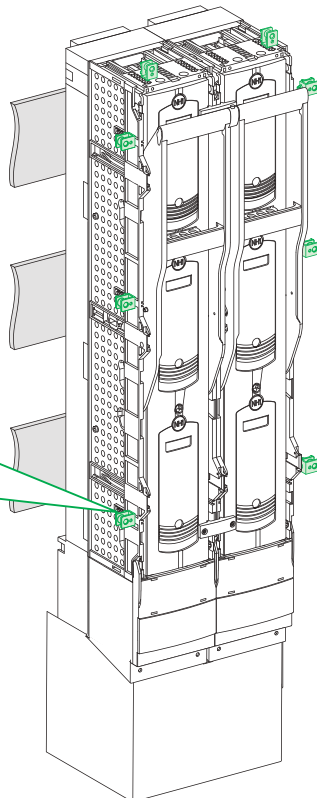
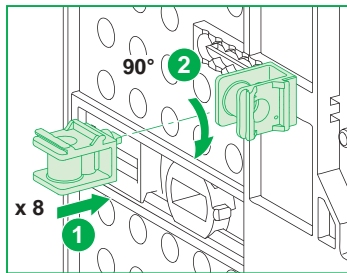
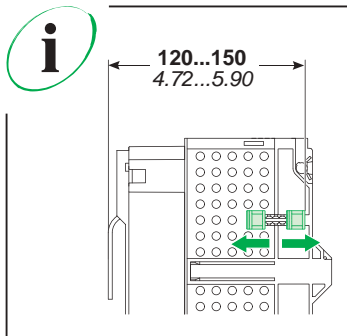

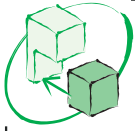

⚠️ ⚠️ DANGER / DANGER / PELIGRO / 危險 / GEFAHR / PERICOLO / PERIGO / ОПАСНОСТЬ

HAZARD OF ELECTRIC SHOCK, EXPLOSION OR ARC FLASH
Install the FuPacT ISFL1250 3P device and the fuse monitor in an electric panel with a solid door or a protective screen in front of the fuse monitor. In that case, the system conserves the class 2 ranking of the panel.

Failure to follow these instructions will result in death or serious injury.

RISQUE D'ÉLECTROCUTION, D'EXPLOSION OU D'ECLAIR D'ARC ELECTRIQUE
Installez l'équipement FuPacT ISFL 1250 3P ainsi que le contrôleur de fusible dans un tableau électrique équipé d'une porte aveugle ou d'un écran de protection placé devant le contrôleur de fusible. Cette installation permet ainsi au système de conserver la catégorie de classe 2 du tableau. **Si ces directives ne sont pas respectées, cela entraînera la mort ou des blessures graves.**

PELIGRO DE DESCARGA ELÉCTRICA, EXPLOSIÓN O ARCO ELECTRICO
Instale el dispositivo FuPacT ISFL1250 3P y el aparato de supervisión de fusibles en un panel eléctrico con una puerta ciega o una pantalla protectora delante del aparato de supervisión de fusibles. En ese caso, el sistema conserva la categoría de clase 2 del panel. **El incumplimiento de estas instrucciones podrá causar la muerte o lesiones serias.**

电击、爆炸或电弧闪光危险
在电气面板中安装 FuPacT ISFL1250 3P 设备和熔断器监视器，并且在熔断器监视器前面安装一个实心门或防护屏。在这种情况下，系统会保留面板的 2 级排名。不遵循上述说明将导致人员伤亡。

GEFAHR VON ELEKTRISCHEM SCHLAG, EXPLOSION ODER LICHTBOGEN
Installieren Sie das FuPacT ISFL1250 3P-Gerät und die Sicherungsüberwachung in einer Schalttafel mit einer Volltür oder mit einer Schutzabdeckung vor der Sicherungsüberwachung. In diesem Fall wird die Schutzklasse II dieser Schalttafel durch das System aufrechterhalten. **Die Nichtbeachtung dieser Anweisungen führt zu Tod oder schweren Verletzungen.**

RISCHIO DI FOLGORAZIONE, ESPLOSIONE O BAGLIORI DA ARCO
Installare il dispositivo FuPacT ISFL 1250 3P e il monitor del fusibile in un pannello elettrico con uno sportello rigido o uno schermo protettivo di fronte al monitor del fusibile. In ogni caso, il sistema mantiene la classificazione di classe 2 del pannello. **Il mancato rispetto di queste istruzioni provocherà morte o gravi infortuni.**

PERIGO DE CHOQUE ELÉCTRICO, EXPLOSIÃO OU ARCO ELÉCTRICO
Instale o dispositivo FuPacT ISFL1250 3P e o monitor de fusíveis em um painel elétrico com uma porta porta cega ou uma tela protetora em frente ao monitor de fusíveis. Nesse caso, o sistema conserva a posição de classe 2 do painel. **A não observância destas instruções resultará em morte, ou ferimentos graves.**

Опасность поражения электрическим током, взрыва или возникновения дуги
Установите устройство FuPacT ISFL 1250 3P и монитор предохранителей в электрическую панель с надежной дверцей или защитным экраном перед монитором предохранителей. В этом случае система сохранит класс 2 для панели. **Несоблюдение этих инструкций приведет к смерти или серьезной травме.**

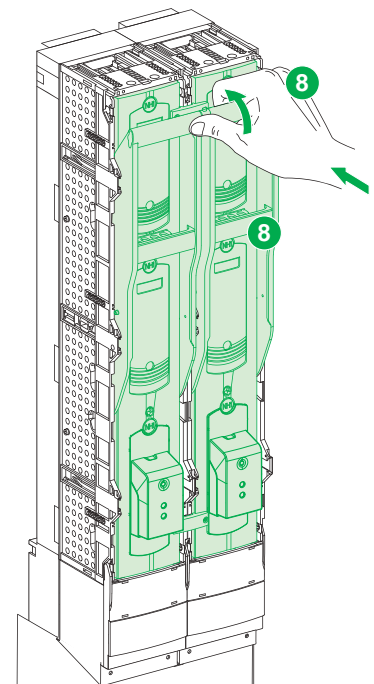
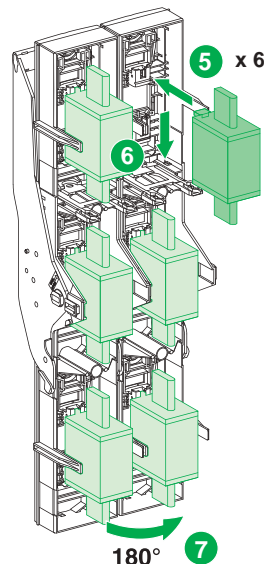
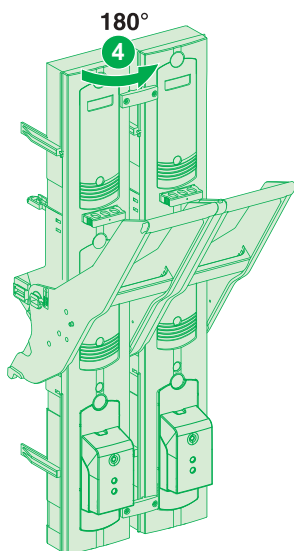
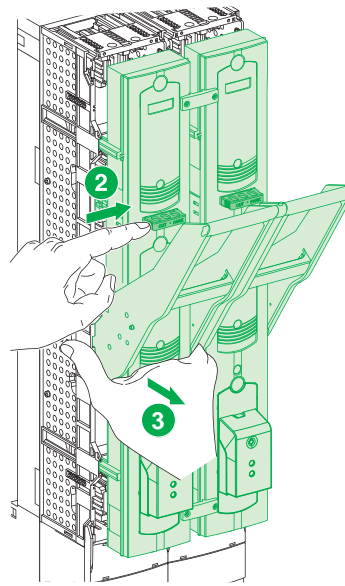
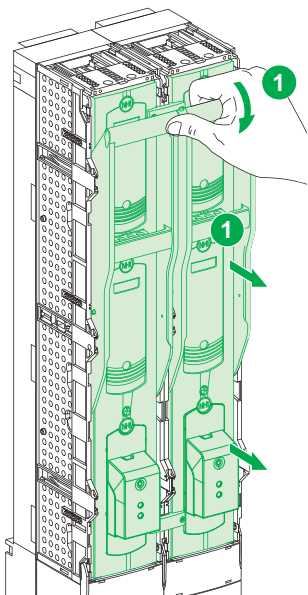
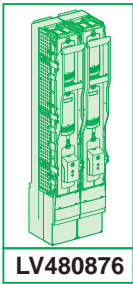

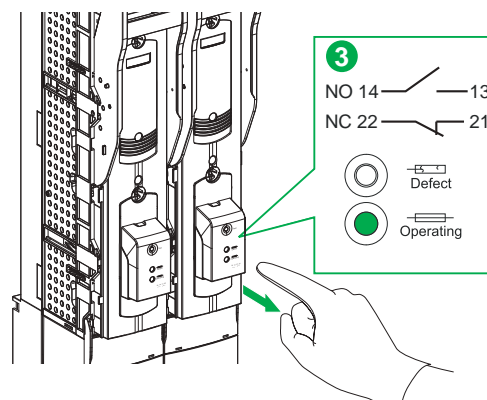
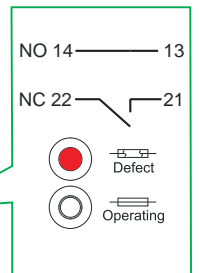
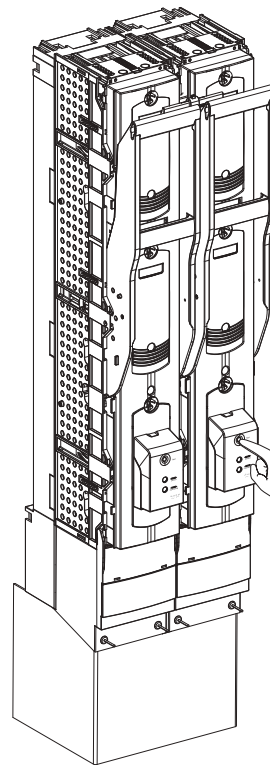
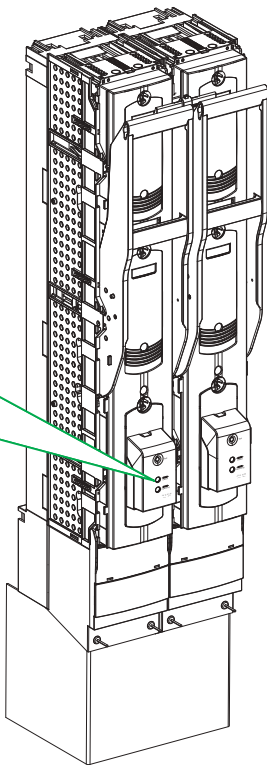
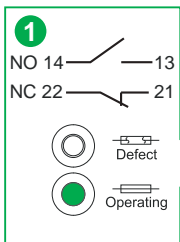
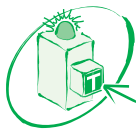
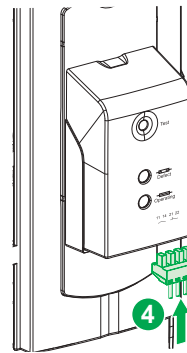
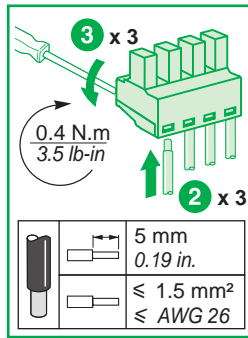
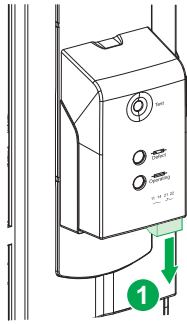
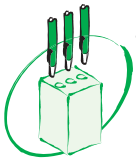

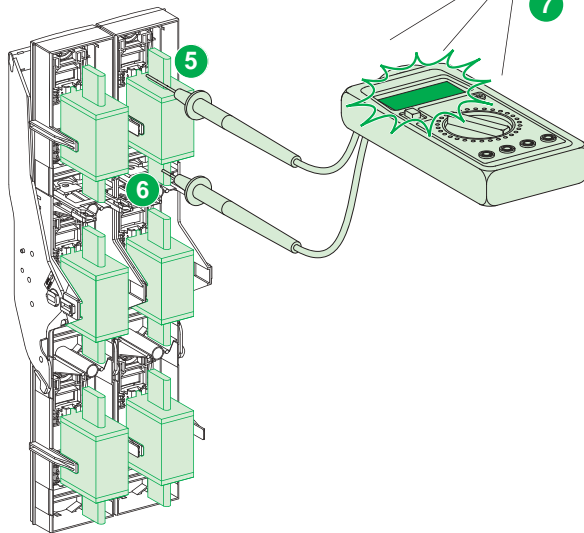
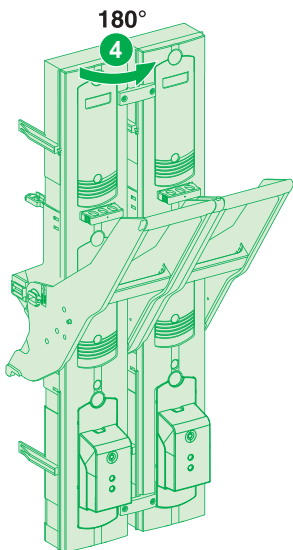
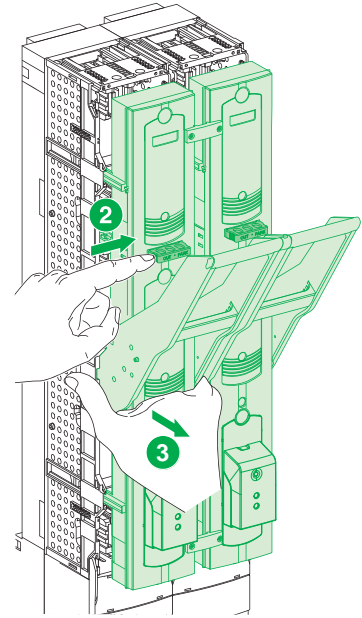
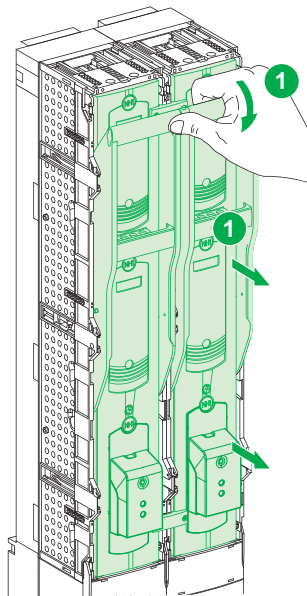
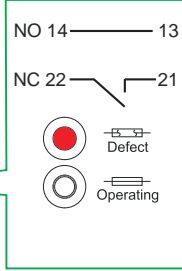
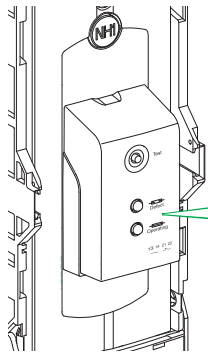
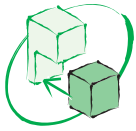

en Replace the faulty fuse(s).

fr Remplacez le (ou les) fusible(s) hors service.

es Sustituya los fusibles fuera de servicio.

zh 更换故障的保险丝。

de Die nicht betriebsfähige(n) Sicherung(en) austauschen.

it Sostituire uno o più fusibili guasti.

pt Substitua o(s) fusível(eis) avariado(s).

ru Замените один или несколько неисправных предохранителей.

⚠ ⚠ DANGER / DANGER / PELIGRO / 危險 / GEFAHR / PERICOLO / PERIGO / ОПАСНОСТЬ

HAZARD OF ELECTRIC SHOCK, EXPLOSION OR ARC FLASH
 Use fuses with silver-plated contact surfaces.

Failure to follow these instructions will result in death or serious injury.

RISQUE D'ÉLECTROCUTION, D'EXPLOSION OU D'ECLAIR D'ARC ELECTRIQUE
 Utilisez des fusibles à surfaces de contact plaquées argent.

Si ces directives ne sont pas respectées, cela entraînera la mort ou des blessures graves.

PELIGRO DE DESCARGA ELÉCTRICA, EXPLOSIÓN O ARCO ELÉCTRICO
 Utilice fusibles con superficies de contacto chapadas en plata.

El incumplimiento de estas instrucciones podrá causar la muerte o lesiones serias.

电击、爆炸或电弧闪光危险
 使用带镀银接触层的保险丝。
 不遵循上述说明将导致人员伤亡。

GEFAHR VON ELEKTRISCHEM SCHLAG, EXPLOSION ODER LICHTBOGEN

Verwenden Sie Sicherungen mit versilberten Kontaktflächen.
Die Nichtbeachtung dieser Anweisungen führt zu Tod oder schweren Verletzungen.

RISCHIO DI FOLGORAZIONE, ESPLOSIONE O BAGLIORI DA ARCO
 Utilizzare fusibili con superfici di contatto placcate in argento.

Il mancato rispetto di queste istruzioni provocherà morte o gravi infortuni.

PERIGO DE CHOQUE ELÉCTRICO, EXPLOSIÃO OU ARCO ELÉCTRICO
 Usar fusíveis com superfícies de contato prateadas.

A não observância destas instruções resultará em morte, ou ferimentos graves.

ОПАСНОСТЬ ВЗРЫВА, ВСПЫШКИ ДУГИ ИЛИ ПОРАЖЕНИЯ ЭЛЕКТРИЧЕСКИМ ТОКОМ

Используйте предохранители с посеребрёнными контактными поверхностями.
Несоблюдение этих инструкций приведет к смерти или серьёзной травме.

en If you have another status, please change the fuse monitor.

fr Si vous avez un statut différent, changez le contrôleur de fusible.

es Si se observa un estatus diferente, cambiar el controlador de fusible.

zh 若状况不同，请更换保险丝控制器。

de Falls ein anderer Anzeigestatus vorliegt, wechseln Sie bitte die Sicherungsüberwachung aus.

it Se avete un altro status, per favore cambiare il controllo del fusibile.

pt Se tiver um estado diferente, substituir o controlador de fusível.

ru Если у вас есть другой статус, пожалуйста, измените монитор предохранителей.

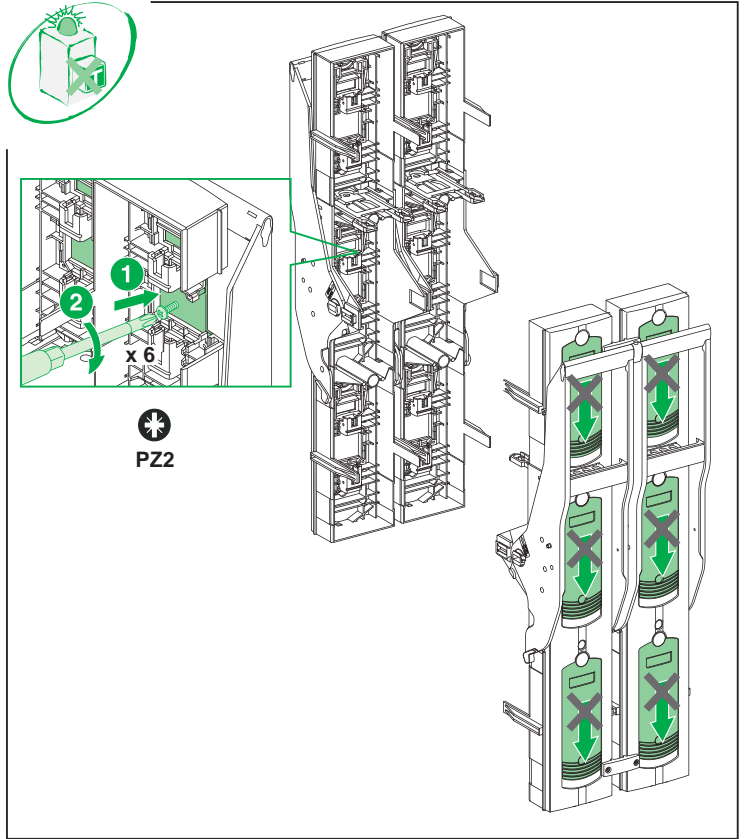
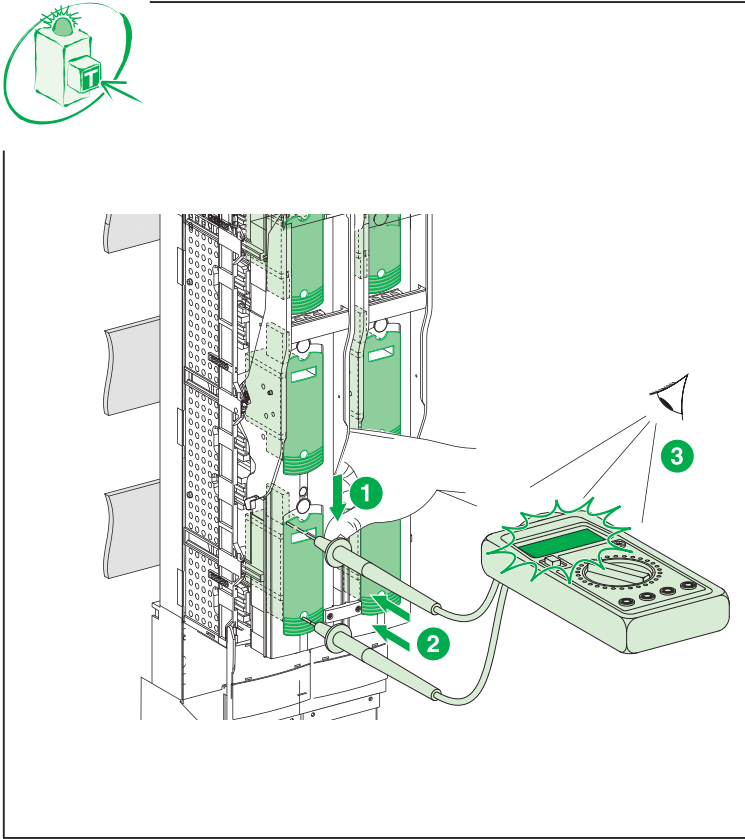

Schneider Electric Industries SAS

35 rue Joseph Monier
CS 30323
F - 92506 Rueil Malmaison Cedex
www.se.com



Printed on recycled paper.

Designed by: Schneider Electric
Printed by:

Schneider Electric Limited

Stafford Park 5
Telford, TF3 3BL
United Kingdom
www.se.com/uk



Уполномоченный поставщик в РФ:

АО «Шнейдер Электрик»

Адрес: 127018, г. Москва, ул.
Двинцев, д. 12, корп. 1,
тел. +7 (495) 777 99 88,
факс: +7 (495) 777 99 94, 8-800-200-6446
www.se.com/ru

