



IHM06-06NPSVT0K

IMM

INDUCTIVE PROXIMITY SENSORS

SICK
Sensor Intelligence.



Illustration may differ



Ordering information

| Type | Part no. |
|-----------------|----------|
| IHM06-06NPSVTOK | 1104507 |

Other models and accessories → www.sick.com/IMM

Detailed technical data

Features

| | |
|---|--|
| Housing | Cylindrical smooth housing |
| Housing | Short-body |
| Diameter | Ø 6.5 mm |
| Sensing range S_n | 6 mm |
| Safe sensing range S_a | 4.86 mm |
| Installation type | Non-flush |
| Switching frequency | 1,000 Hz |
| Connection type | Connector M8, 3-pin |
| Switching output | PNP |
| Output function | NO |
| Electrical wiring | DC 3-wire |
| Enclosure rating | IP67 ¹⁾ |
| Special features | Visual adjustment indicator, IO-Link, triple sensing range |

¹⁾ According to EN 60529.

Mechanics/electronics

| | |
|-----------------------|----------------------|
| Supply voltage | 10 V DC ... 30 V DC |
| Ripple | ≤ 20 % ¹⁾ |
| Voltage drop | ≤ 2 V ²⁾ |

¹⁾ Of V_S.

²⁾ With I_a = 200 mA.

³⁾ Supply voltage U_B and constant ambient temperature T_a.

| | |
|---|--|
| Time delay before availability | ≤ 80 ms |
| Hysteresis | 1 % ... 10 % |
| Reproducibility | ≤ 2 % ³⁾ |
| Temperature drift (of S_r) | ≤ 10 % |
| EMC | EN 60947-5-2 |
| Continuous current I_a | ≤ 200 mA |
| Short-circuit protection | ✓ |
| Reverse polarity protection | ✓ |
| Power-up pulse protection | ✓ |
| Shock and vibration resistance | 30 g, 11 ms / 10 ... 55 Hz, 1 mm |
| Ambient operating temperature | -25 °C ... +70 °C |
| Housing material | Stainless steel V2A, DIN 1.4305 / AISI 303 |
| Sensing face material | Plastic, LCP |
| Housing length | 40 mm |
| UL File No. | NRKH.E348498 |

¹⁾ Of V_S.

²⁾ With I_a = 200 mA.

³⁾ Supply voltage U_B and constant ambient temperature T_a.

Safety-related parameters

| | |
|-------------------------|-------------|
| MTTF_D | 1,330 years |
| DC_{avg} | 0 % |

Communication interface

| | |
|---------------------------------------|--|
| Communication interface | IO-Link V1.1 |
| Communication Interface detail | COM2 (38,4 kBaud) |
| Cycle time | 10.4 ms |
| Process data length | 1 Byte |
| Process data structure | Bit 0 = Sr reached Bit 1 = Sa reached |

Reduction factors

| | |
|-----------------------------------|--|
| Note | The values are reference values which may vary |
| St37 steel (Fe) | 1 |
| Stainless steel (V2A, 304) | Approx. 0.75 |
| Aluminum (Al) | Approx. 0.5 |
| Copper (Cu) | Approx. 0.43 |
| Brass (Br) | Approx. 0.54 |

Installation note

| | |
|---------------|---------------------------------------|
| Remark | Associated graphic see "Installation" |
| A | 12 mm |
| B | 35 mm |
| C | 6.5 mm |
| D | 18 mm |

| | |
|----------|-------|
| E | 12 mm |
| F | 48 mm |

Classifications

| | |
|-----------------------|----------|
| ECLASS 5.0 | 27270101 |
| ECLASS 5.1.4 | 27270101 |
| ECLASS 6.0 | 27270101 |
| ECLASS 6.2 | 27270101 |
| ECLASS 7.0 | 27270101 |
| ECLASS 8.0 | 27270101 |
| ECLASS 8.1 | 27270101 |
| ECLASS 9.0 | 27270101 |
| ECLASS 10.0 | 27270101 |
| ECLASS 11.0 | 27270101 |
| ECLASS 12.0 | 27274001 |
| ETIM 5.0 | EC002714 |
| ETIM 6.0 | EC002714 |
| ETIM 7.0 | EC002714 |
| ETIM 8.0 | EC002714 |
| UNSPSC 16.0901 | 39122230 |

Adjustments

Installation aid

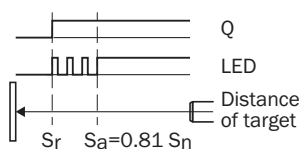

Installation note

Fixing with setscrew

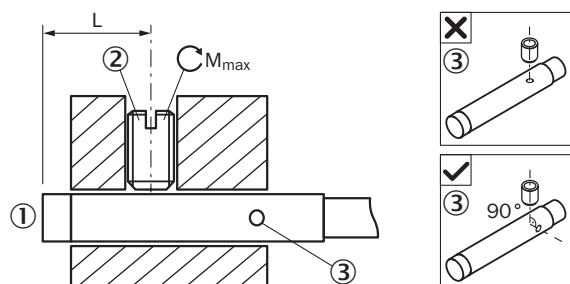

- ① Sensing face
- ② Recommended setscrew: M3, flat point
- ③ Display LED

| Sensor type | Mounting area (L) | Max. tightening torque (M_{max}) |
|-----------------|-------------------|--------------------------------------|
| IHM06-04N*****K | 8 mm ... 21 mm | ≤ 0.4 Nm |
| IHM06-04N***TOK | 8 mm ... 32 mm | ≤ 0.4 Nm |
| IHM06-04N*****S | 8 mm ... 32 mm | ≤ 0.4 Nm |
| IHM06-04N***TOS | 8 mm ... 42 mm | ≤ 0.4 Nm |
| IHM06-06N*****K | 12 mm ... 21 mm | ≤ 0.4 Nm |
| IHM06-06N***TOK | 12 mm ... 32 mm | ≤ 0.4 Nm |
| IHM06-06N*****S | 12 mm ... 32 mm | ≤ 0.4 Nm |
| IHM06-06N***TOS | 12 mm ... 42 mm | ≤ 0.4 Nm |

Mounting using BEF-KH-M06 bracket

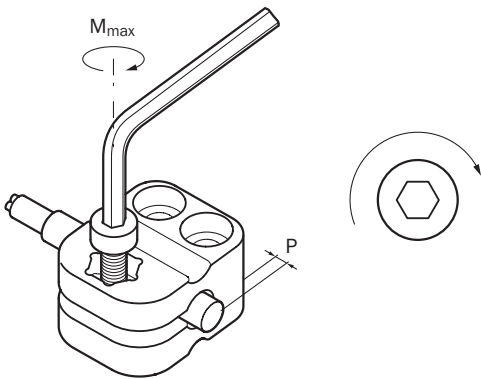

| Sensor type | Mounting adapter | Overrun (P) | Max. tightening torque (M_{max}) |
|----------------------------------|------------------------------|-------------|--------------------------------------|
| IHM06-04N***** IHM06-06N***** | BEF-KH-M06, part no. 2101067 | ≥ 4 mm | ≤ 0.6 Nm |

Non-flush installation

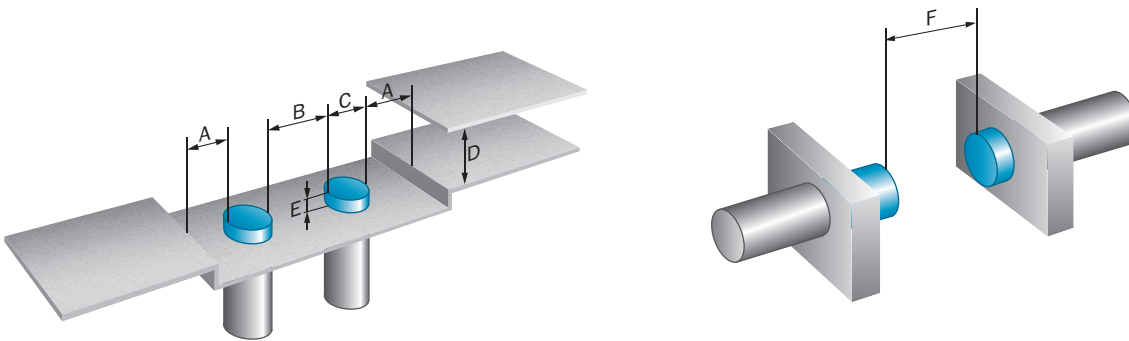

Connection diagram

Cd-002

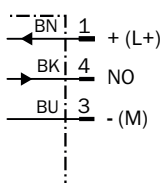

Response diagram

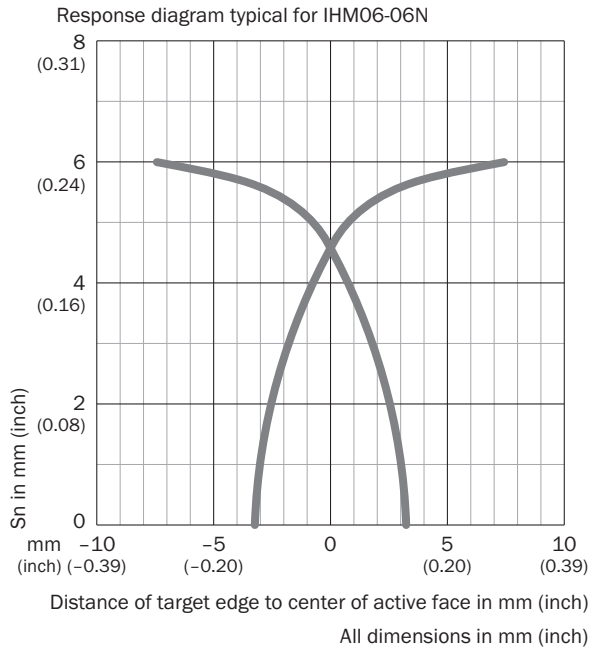

Dimensional drawing (Dimensions in mm (inch))

IHM06, short variant, non-flush, male connector

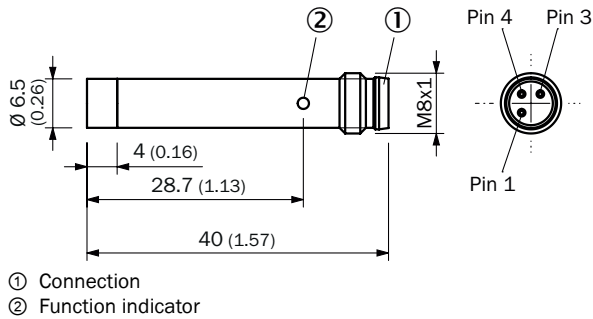







Recommended accessories

Other models and accessories → www.sick.com/IMM

| | Brief description | Type | Part no. |
|---|---|------------|----------|
| Plug connectors and cables | | | |
|  | <ul style="list-style-type: none"> • Connection type head A: Male connector, M8, 3-pin, straight • Description: Unshielded • Connection systems: Screw-type terminals • Permitted cross-section: 0.14 mm² ... 0.5 mm² | STE-0803-G | 6037322 |

| | Brief description | Type | Part no. |
|---|---|--------------------|----------|
|  | <ul style="list-style-type: none"> • Connection type head A: Male connector, M8, 3-pin, angled • Description: Unshielded • Connection systems: Screw-type terminals • Permitted cross-section: 0.14 mm² ... 0.5 mm² | STE-0803-WSK | 6053170 |
| Terminal and alignment brackets | | | |
|  | Plastic (PA6), without mounting hardware | BEF-KH-M06 | 2101067 |
| Others | | | |
|  | <ul style="list-style-type: none"> • Connection type head A: 3-pin • Slot connection type: M8, 3-pin, A-coded, female connector • Description: Unshielded • Items supplied: 5 x labeling plates | Y8A34A2-C2A8000XXX | 2115733 |
|  | | Y8A36A2-C2A8000XXX | 2115734 |
|  | <ul style="list-style-type: none"> • Connection type head A: 3-pin • Slot connection type: M8, 3-pin, A-coded, female connector • Cable: 5 m, 6-wire, PUR, halogen-free • Description: Unshielded • Application: Drag chain operation • Items supplied: 5 x labeling plates | Y8A34A2-LXXXUAA050 | 2115727 |
|  | | Y8A36A2-LXXXUBA050 | 2115728 |
|  | <ul style="list-style-type: none"> • Connection type head A: Female connector, M8, 3-pin, straight, A-coded • Connection type head B: Flying leads • Signal type: Sensor/actuator cable • Cable: 2 m, 3-wire, PUR, halogen-free • Description: Sensor/actuator cable, unshielded • Application: Zones with oils and lubricants, Drag chain operation, Robot | YF8U13-020UA1XLEAX | 2094782 |
|  | | YF8U13-050UA1XLEAX | 2094788 |
|  | <ul style="list-style-type: none"> • Connection type head A: Female connector, M8, 3-pin, straight, A-coded • Connection type head B: Flying leads • Signal type: Sensor/actuator cable • Cable: 2 m, 3-wire, PVC • Description: Sensor/actuator cable, unshielded • Application: Zones with chemicals | YF8U13-020VA1XLEAX | 2095860 |
|  | | YF8U13-050VA1XLEAX | 2095884 |
|  | <ul style="list-style-type: none"> • Connection type head A: Female connector, M8, 3-pin, angled, A-coded • Connection type head B: Flying leads • Signal type: Sensor/actuator cable • Cable: 2 m, 3-wire, PUR, halogen-free • Description: Sensor/actuator cable, unshielded • Application: Zones with oils and lubricants, Drag chain operation, Robot | YG8U13-020UA1XLEAX | 2094794 |

| | Brief description | Type | Part no. |
|---|--|--------------------|----------|
|  | <ul style="list-style-type: none"> • Connection type head A: Female connector, M8, 3-pin, angled, A-coded • Connection type head B: Flying leads • Signal type: Sensor/actuator cable • Cable: 5 m, 3-wire, PUR, halogen-free • Description: Sensor/actuator cable, unshielded • Application: Zones with oils and lubricants, Drag chain operation, Robot | YG8U13-050UA1XLEAX | 2095586 |
|  | <ul style="list-style-type: none"> • Connection type head A: Female connector, M8, 3-pin, angled, A-coded • Connection type head B: Flying leads • Signal type: Sensor/actuator cable • Cable: 2 m, 3-wire, PVC • Description: Sensor/actuator cable, unshielded • Application: Zones with chemicals | YG8U13-020VA1XLEAX | 2096165 |
|  | <ul style="list-style-type: none"> • Connection type head A: Female connector, M8, 3-pin, angled, A-coded • Connection type head B: Flying leads • Signal type: Sensor/actuator cable • Cable: 5 m, 3-wire, PVC • Description: Sensor/actuator cable, unshielded • Application: Zones with chemicals | YG8U13-050VA1XLEAX | 2096166 |
|  | <ul style="list-style-type: none"> • Connection type head A: Female connector, M8, 3-pin, straight, A-coded • Connection type head B: Male connector, M12, 3-pin, straight, A-coded • Signal type: Sensor/actuator cable • Cable: 2 m, 3-wire, PUR, halogen-free • Description: Sensor/actuator cable, unshielded • Application: Zones with oils and lubricants, Drag chain operation, Robot | YF8U13-020UA1M2A13 | 2096169 |
|  | <ul style="list-style-type: none"> • Connection type head A: Female connector, M8, 3-pin, straight, A-coded • Connection type head B: Male connector, M12, 3-pin, straight, A-coded • Signal type: Sensor/actuator cable • Cable: 5 m, 3-wire, PUR, halogen-free • Description: Sensor/actuator cable, unshielded • Application: Zones with oils and lubricants, Drag chain operation, Robot | YF8U13-050UA1M2A13 | 2096170 |
|  | <ul style="list-style-type: none"> • Connection type head A: Female connector, M8, 3-pin, straight, A-coded • Connection type head B: Male connector, M12, 3-pin, straight, A-coded • Signal type: Sensor/actuator cable • Cable: 2 m, 3-wire, PVC • Description: Sensor/actuator cable, unshielded • Application: Zones with chemicals | YF8U13-020VA1M2A13 | 2096605 |
|  | <ul style="list-style-type: none"> • Connection type head A: Female connector, M8, 3-pin, straight, A-coded • Connection type head B: Male connector, M12, 3-pin, straight, A-coded • Signal type: Sensor/actuator cable • Cable: 5 m, 3-wire, PVC • Description: Sensor/actuator cable, unshielded • Application: Zones with chemicals | YF8U13-050VA1M2A13 | 2096606 |
|  | <ul style="list-style-type: none"> • Connection type head A: Female connector, M8, 3-pin, angled, A-coded • Connection type head B: Male connector, M12, 3-pin, straight, A-coded • Signal type: Sensor/actuator cable • Cable: 2 m, 3-wire, PUR, halogen-free • Description: Sensor/actuator cable, unshielded • Application: Zones with oils and lubricants, Drag chain operation, Robot | YG8U13-020UA1M2A13 | 2095748 |
|  | <ul style="list-style-type: none"> • Connection type head A: Female connector, M8, 3-pin, straight, A-coded • Connection type head B: Male connector, M8, 3-pin, straight, A-coded • Signal type: Sensor/actuator cable • Cable: 2 m, 3-wire, PUR, halogen-free • Description: Sensor/actuator cable, unshielded • Application: Zones with oils and lubricants, Drag chain operation, Robot | YF8U13-020UA1M8U13 | 2096304 |
|  | <ul style="list-style-type: none"> • Connection type head A: Female connector, M8, 3-pin, straight, A-coded • Connection type head B: Male connector, M8, 3-pin, straight, A-coded • Signal type: Sensor/actuator cable • Cable: 5 m, 3-wire, PUR, halogen-free • Description: Sensor/actuator cable, unshielded • Application: Zones with oils and lubricants, Drag chain operation, Robot | YF8U13-050UA1M8U13 | 2096308 |

| | Brief description | Type | Part no. |
|---|--|--------------------|----------|
|  | <ul style="list-style-type: none"> • Connection type head A: Female connector, M8, 3-pin, angled, A-coded • Connection type head B: Male connector, M8, 3-pin, straight, A-coded • Signal type: Sensor/actuator cable • Cable: 2 m, 3-wire, PUR, halogen-free • Description: Sensor/actuator cable, unshielded • Application: Zones with oils and lubricants, Drag chain operation, Robot | YG8U13-020UA1M8U13 | 2107781 |
|  | <ul style="list-style-type: none"> • Connection type head A: Female connector, M8, 3-pin, angled, A-coded • Connection type head B: Male connector, M12, 3-pin, straight, A-coded • Signal type: Sensor/actuator cable • Cable: 5 m, 3-wire, PUR, halogen-free • Description: Sensor/actuator cable, unshielded • Application: Zones with oils and lubricants, Drag chain operation, Robot | YG8U13-050UA1M2A13 | 2122842 |

SICK AT A GLANCE

SICK is one of the leading manufacturers of intelligent sensors and sensor solutions for industrial applications. A unique range of products and services creates the perfect basis for controlling processes securely and efficiently, protecting individuals from accidents and preventing damage to the environment.

We have extensive experience in a wide range of industries and understand their processes and requirements. With intelligent sensors, we can deliver exactly what our customers need. In application centers in Europe, Asia and North America, system solutions are tested and optimized in accordance with customer specifications. All this makes us a reliable supplier and development partner.

Comprehensive services complete our offering: SICK LifeTime Services provide support throughout the machine life cycle and ensure safety and productivity.

For us, that is “Sensor Intelligence.”

WORLDWIDE PRESENCE:

Contacts and other locations –www.sick.com