



# M40S-026003AA0

M4000 Advanced

**SAFETY MULTIBEAM SENSORS**

**SICK**  
Sensor Intelligence.



### Ordering information

Scanning range	Number of beams	Beam separation	System part	Type	Part no.
0.5 m ... 70 m, configurable	2	600 mm	Sender	M40S-026003AA0	1200070

Other models and accessories → [www.sick.com/M4000\\_Advanced](http://www.sick.com/M4000_Advanced)

Illustration may differ



### Detailed technical data

#### Features

<b>Scanning range</b>	0.5 m ... 70 m, configurable
<b>Low scanning range</b>	0.5 m ... 20 m
<b>Great scanning range</b>	9 m ... 70 m
<b>Number of beams</b>	2
<b>Beam separation</b>	600 mm
<b>Response time</b>	10 ms
<b>Synchronization</b>	Optical synchronisation

#### Safety-related parameters

<b>Type</b>	Type 4 (IEC 61496-1)
<b>Safety integrity level</b>	SIL 3 (IEC 61508)
<b>Category</b>	Category 4 (EN ISO 13849)
<b>Performance level</b>	PL e (EN ISO 13849)
<b>PFH<sub>D</sub> (mean probability of a dangerous failure per hour)</b>	$6.6 \times 10^{-9}$ (EN ISO 13849)
<b>T<sub>M</sub> (mission time)</b>	20 years (EN ISO 13849)
<b>Safe state in the event of a fault</b>	At least one OSSD is in the OFF state.

#### Functions

	Functions	Delivery status
<b>Beam coding</b>	✓	Uncoded
<b>Restart interlock</b>	✓	
<b>External device monitoring (EDM)</b>	✓	
<b>Sender test</b>	✓	Deactivated
<b>Configurable scanning range</b>	✓	
<b>Configurable application diagnostic output</b>	✓	Contamination (OWS)
<b>Safe SICK device communication via EFI</b>	✓	

	Functions	Delivery status
<b>Differentiation between man and material (muting)</b>	✓	
Type of human-material differentiation	Flexible, configurable 4-signal muting	

## Interfaces

<b>System connection</b>	Hirschmann male connector M26, 12-pin
Permitted cable length	50 m <sup>1)</sup>
Permitted cross-section	≥ 0.75 mm <sup>2</sup>
<b>Configuration connection</b>	Female connector M8, 4-pin
<b>Configuration method</b>	PC with CDS (Configuration and Diagnostic Software)
<b>Display elements</b>	LEDs 7-segment display

<sup>1)</sup> Depending on load, power supply and wire cross-section. The technical specifications must be observed.

## Electrical data

<b>Protection class</b>	III (IEC 61140)
<b>Supply voltage <math>V_S</math></b>	24 V DC (19.2 V DC ... 28.8 V DC) <sup>1)</sup>
<b>Residual ripple</b>	≤ 10 % <sup>2)</sup>
<b>Power consumption</b>	≤ 0.2 A

<sup>1)</sup> The external voltage supply must be capable of buffering brief mains voltage failures of 20 ms as specified in EN 60204-1. Suitable power supplies are available as accessories from SICK.

<sup>2)</sup> Within the limits of  $V_S$ .

## Mechanical data

<b>Dimensions</b>	See dimensional drawing
<b>Housing cross-section</b>	52 mm x 55.5 mm
<b>Material</b>	
Housing	Aluminum alloy ALMGSI 0.5, powder coated
Front screen	Polycarbonate, scratch-resistant coating

## Ambient data

<b>Enclosure rating</b>	IP65 (EN 60529)
<b>Ambient operating temperature</b>	-30 °C ... +55 °C
<b>Storage temperature</b>	-30 °C ... +70 °C
<b>Air humidity</b>	15 % ... 95 %, Non-condensing
<b>Shock resistance</b>	10 g, 16 ms (IEC 60068-2-29)

## Other information

<b>Wave length</b>	850 nm
--------------------	--------

## Classifications

<b>eCl@ss 5.0</b>	27272703
<b>eCl@ss 5.1.4</b>	27272703
<b>eCl@ss 6.0</b>	27272703
<b>eCl@ss 6.2</b>	27272703

eCl@ss 7.0	27272703
eCl@ss 8.0	27272703
eCl@ss 8.1	27272703
eCl@ss 9.0	27272703
eCl@ss 10.0	27272703
eCl@ss 11.0	27272703
eCl@ss 12.0	27272703
ETIM 5.0	EC001832
ETIM 6.0	EC001832
ETIM 7.0	EC001832
ETIM 8.0	EC001832
UNSPSC 16.0901	46171620

### Dimensional drawing (Dimensions in mm (inch))

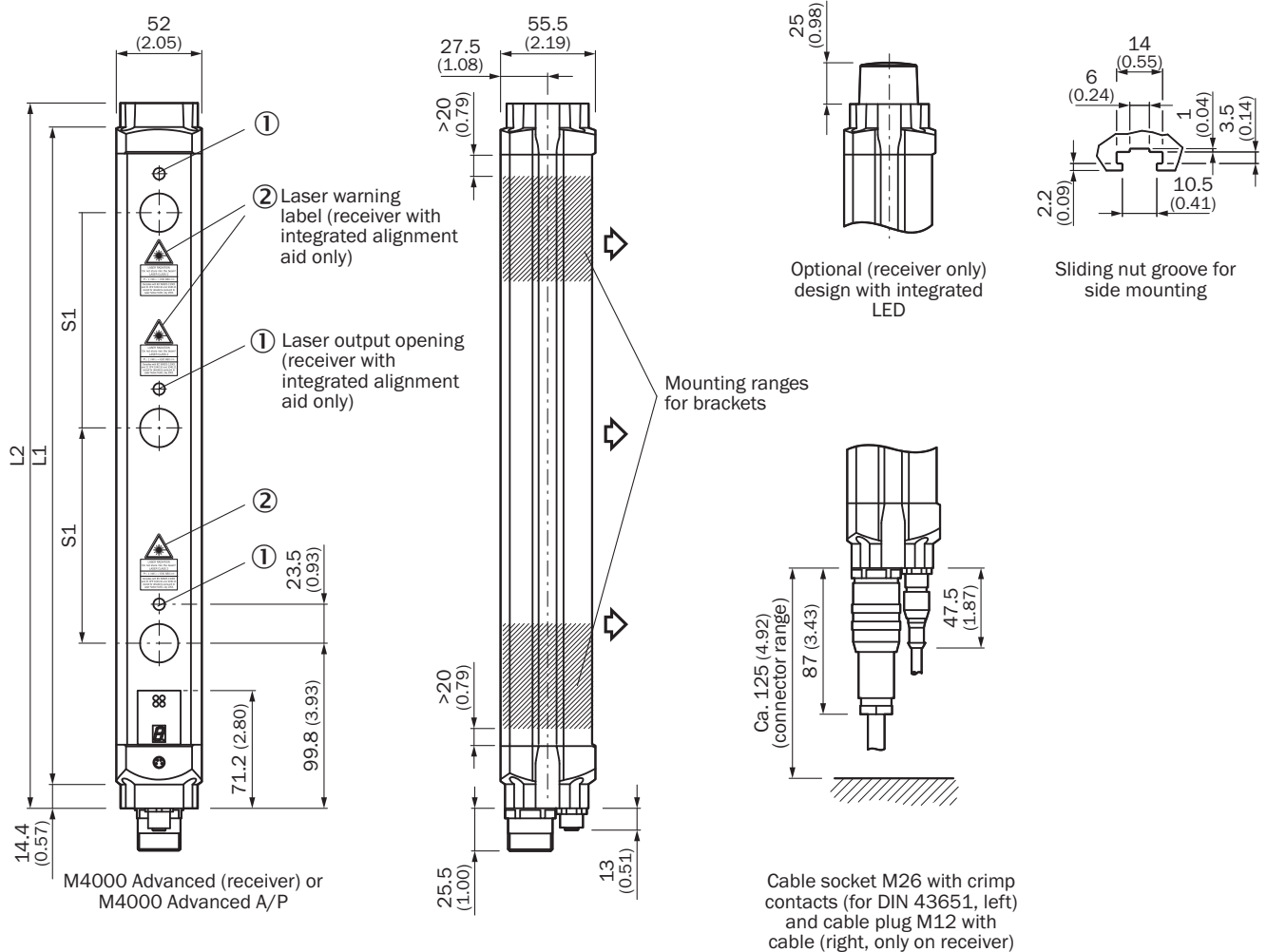















Illustration sender (receiver mirror image)

Number of beams	Beam separation S1	L1	L2
2	500 (19.69)	643 (25.31)	672 (26.46)
	600 (23.62)	743 (29.25)	772 (30.39)
3	220 (8.66)	583 (22.95)	612 (24.09)
	400 (15.75)	943 (37.13)	972 (38.27)
	450 (17.72)	1,043 (41.06)	1,072 (42.20)
4	220 (8.66)	803 (31.61)	832 (32.76)
	300 (11.81)	1,043 (41.06)	1,072 (42.20)
5	220 (8.66)	1,023 (40.28)	1,052 (41.42)
6		1,243 (48.94)	1,272 (50.08)
7		1,462 (57.56)	1,491 (58.70)
8		1,682 (66.22)	1,711 (67.36)

## Recommended accessories

Other models and accessories → [www.sick.com/M4000\\_Advanced](http://www.sick.com/M4000_Advanced)

	Brief description	Type	Part no.
<b>Alignment aids</b>			
	Laser alignment aid for various sensors, laser class 2 (IEC 60825). Do not look into the beam!, 19 mm x 67.3 mm x 66.9 mm	AR60	1015741
	Adapter AR60 for M4000 and M4000 Curtain	AR60 adapter, M4000	4040006
<b>Muting accessories</b>			
	Parallel muting (2 sensors), muting sensor brackets for mounting on M4000 housing profile or device columns with external mounting grooves	Muting arm kit M4000, 2 sensors, parallel muting	2060157
	Parallel muting (2 sensors), muting sensor brackets for mounting on M4000 housing profile or device column with external mounting grooves		2060156
<b>Mounting brackets and plates</b>			
	4 pieces, Mounting kit 1, mounting bracket, rigid, L-shaped, including fixing screws and washers	BEF-3WNGBAST4	7021352
<b>Plug connectors and cables</b>			
	Head A: female connector, M26, 12-pin, straight Head B: Flying leads Cable: Sensor/actuator cable, PVC, unshielded, 5 m	DOL-0612G05M075KM0	2022545
	Head A: female connector, M26, 12-pin, straight Head B: Flying leads Cable: Sensor/actuator cable, PVC, unshielded, 10 m	DOL-0612G10M075KM0	2022547
	Head A: female connector, M26, 12-pin, straight Head B: Flying leads Cable: Sensor/actuator cable, PVC, unshielded, 20 m	DOL-0612G20M075KM0	2022549

	Brief description	Type	Part no.
	Head A: male connector, M8, 4-pin, straight Head B: male connector, USB-A, straight Cable: PVC, unshielded, 2 m	DSL-8U04G02M025KM1	6034574
	Head A: male connector, M8, 4-pin, straight Head B: male connector, USB-A, straight Cable: PVC, unshielded, 10 m	DSL-8U04G10M025KM1	6034575
	Head A: female connector, M12, 5-pin, straight, A-coded Head B: male connector, M12, 5-pin, straight, A-coded Cable: Sensor/actuator cable, PUR, halogen-free, unshielded, 2 m	YF2A15-020UB5M2A15	2096009
	Head A: female connector, M12, 5-pin, straight, A-coded Head B: male connector, M12, 5-pin, straight, A-coded Cable: Sensor/actuator cable, PUR, halogen-free, unshielded, 0.6 m	YF2A15-C60UB5M2A15	2096006
	Head A: female connector, M26, 12-pin, straight Cable: unshielded 12 crimping contacts enclosed	DOS-0612G000GA3KM0	6020757
	Head A: female connector, M26, 12-pin, angled Cable: unshielded 12 crimping contacts enclosed	DOS-0612W000GA3KM0	6020758
<b>Terminal and alignment brackets</b>			
	4 pieces, Mounting kit 6, side bracket, rotatable, zinc diecast	BEF-1SHABAZN4	2019506
	4 pieces, Omega bracket, rotatable, fixable with only one screw, for mounting on the swivel mount, including spacer discs	BEF-2SMGEAAL4	2044846
	4 pieces, Mounting kit 12, rotatable, swivel mount	BEF-2SMGEAKU4	2030510
<b>Switching amplifiers</b>			
	<ul style="list-style-type: none"> <li>• <b>Applications:</b> Muting switching amplifier</li> <li>• <b>Compatible sensor types:</b> M4000 Advanced multiple light beam safety devices</li> </ul>	UE403-A0930	1026287

## SICK AT A GLANCE

SICK is one of the leading manufacturers of intelligent sensors and sensor solutions for industrial applications. A unique range of products and services creates the perfect basis for controlling processes securely and efficiently, protecting individuals from accidents and preventing damage to the environment.

We have extensive experience in a wide range of industries and understand their processes and requirements. With intelligent sensors, we can deliver exactly what our customers need. In application centers in Europe, Asia and North America, system solutions are tested and optimized in accordance with customer specifications. All this makes us a reliable supplier and development partner.

Comprehensive services complete our offering: SICK LifeTime Services provide support throughout the machine life cycle and ensure safety and productivity.

For us, that is “Sensor Intelligence.”

## WORLDWIDE PRESENCE:

Contacts and other locations –[www.sick.com](http://www.sick.com)