

## 508 - Bras double

Code: 991267-00

### INFORMATIONS GÉNÉRALES

Article	508 - Bras double
Code	991267-00

### DIMENSIONS ET POIDS

Longueur (mm)	1040 mm
Largeur (mm)	100 mm
Poids (Kg)	9.1 kg

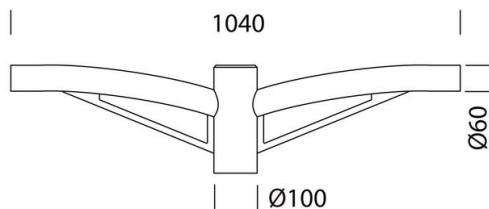

508 Braccio doppio



## 508 - Bras double

Code: 991267-00

### DONNÉES PHOTOMÉTRIQUES



Puissance absorbée (totale) (W)	0 W
------------------------------------	-----

## 508 - Bras double

Code: 991267-00

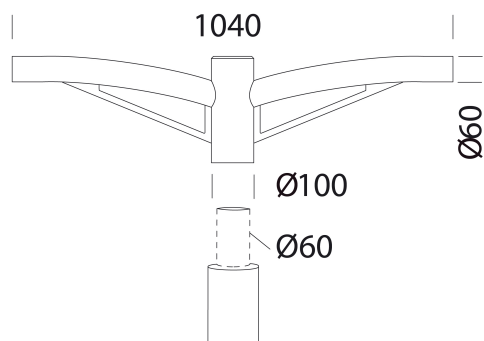

### MATÉRIAUX ET COULEURS

Corps	en acier, pour installation sur mâts avec raccord Ø60.
Couleur	Graphite

### NORMES ET CONFORMITÉ

Marquages et essais	CE
---------------------	----

### GARANTIE

Garantie après-vente	2 yr
----------------------	------

### TÉLÉCHARGEMENT

DESSINS

DessinTechnique 508.dxf



## 508 - Bras double

Code: 991267-00



3472 Giovi M1 - public routier



3269 Mini Stelvio FX T5 - extensif



3278 Mini Stelvio FX T3 - extensif public routier



3376 Mini Stelvio - high performance - grands espaces



3285 Rolle - high performance



3286 Rolle - high performance



3476 Mini Giovi W2 - public routier

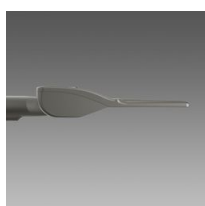

3477 Mini Giovi N1 - piste cyclable



3478 Mini Giovi M1 - public routier



3479 Mini Giovi T4 - grands espaces



3480 Mini Giovi - high performance - grands espaces

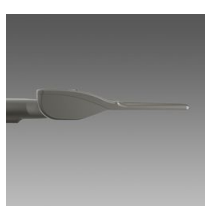

3481 Mini Giovi - high performance - public routier ME

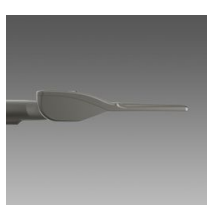

3482 Mini Giovi - high performance - piste cyclable

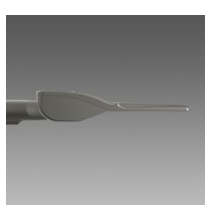

3483 Mini Giovi AMBRE - grands espaces

## 508 - Bras double

Code: 991267-00

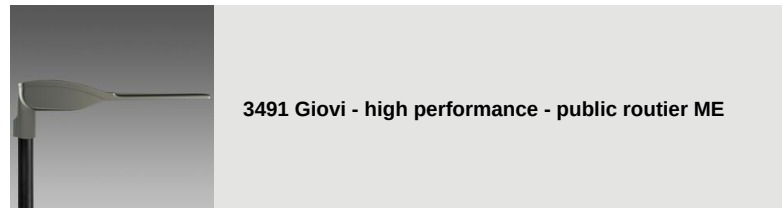
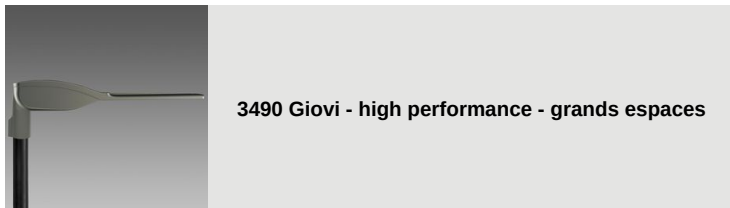
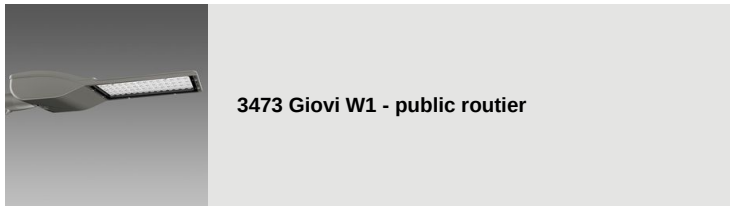



**3375 Mini Stelvio - high performance - public routier**



**3280 Rolle - T1**



**3283 Rolle - T4**



**3284 Rolle - T5**



**3290 Sella 1 - ST**



**3291 Sella 1 - STWB**



**3292 Sella 1 - asymétrique 45°**



**3293 Sella 1 - asymétrique 60°**



**3294 Sella 1 - pistes cyclables**



**3295 Sella 1 - grands espaces**



**3296 Sella 1 - HP**



**3297 Sella 1 - HP - passages piétons SX**



**3298 Sella 1 - HP - passages piétons DX**



**3390 Sella 2 - ST**



**3391 Sella 2 - STWB**



**3392 Sella 2 - asymétrique 45°**



**3393 Sella 2 - asymétrique 60°**



**3395 Sella 2 - grands espaces**



**3396 Sella 2 - HP**



**3270 Stelvio 1 - Plus - LED**



**3274 Stelvio 2 - Plus - LED asymétrique**



**3370 Stelvio - high performance - public routier**



**3374 Stelvio - high performance - grands espaces**



**3475 Mini Giovi W1 - public routier**



**3275 Mini Stelvio - public routier**



**3276 Mini Stelvio - asymétrique**



**3281 Rolle - T2**



**3282 Rolle - T3**



*Pour toute information technique, contacter le service d'études et de conseils. Le flux lumineux sortant mentionné est le flux lumineux du luminaire, avec une tolérance de  $\pm 10\%$  par rapport à la valeur indiquée. La puissance absorbée totale ne dépasse pas 10 % de la valeur indiquée. Des modifications et des optimisations peuvent être apportées aux données techniques en raison de la rapidité de l'évolution technologique. Sunday, August 13, 2023*