



UM30-21411B

UM30

ULTRASONIC DISTANCE SENSORS

SICK
Sensor Intelligence.



Ordering information

Type	Part no.
UM30-21411B	6068450

Other models and accessories → www.sick.com/UM30



Detailed technical data

Mechanics/electronics

Supply voltage V_s	DC 9 V ... 30 V ¹⁾
Power consumption	≤ 2.4 W ²⁾
Initialization time	< 300 ms
Design	Cylindrical
Housing material	Metal (nickel-plated brass, PBT, ultrasonic transducer: polyurethane foam, glass epoxy resin)
Thread size	M30 x 1.5
Connection type	Male connector, M12, 5-pin
Indication	LED display, 2 x LED
Weight	210 g
Sending axis	Straight
Dimensions (W x H x D)	47.5 mm x 47.5 mm x 102 mm
Enclosure rating	IP65 / IP67
Protection class	III

¹⁾ Limit values, reverse-polarity protected Operation in short-circuit protected network: max. 8 A, class 2.

²⁾ Without load.

Performance

Operating range, limiting range	350 mm ... 3,400 mm, 5,000 mm
Target	Natural objects
Resolution	≥ 0.18 mm

¹⁾ In relation to the current measured value, minimum value ≥ resolution.

²⁾ Referring to current measurement value.

³⁾ Temperature compensation can be switched off, without temperature compensation: 0.17 % / K.

Repeatability	± 0.15 % ¹⁾
Accuracy	± 1 % ^{2) 3)}
Temperature compensation	✓
Response time	180 ms
Switching frequency	4 Hz
Output time	43 ms
Ultrasonic frequency (typical)	120 kHz
Detection area (typical)	See diagrams
Additional function	Adjustable operating modes: Switching point (Dt0) / Switching window/Background (ObSB) Teach-in of digital output Set levels of digital outputs Invertable digital output Set on delay digital output Synchronization of up to 50 sensors Multiplexing: no cross talk of up to 50 sensors Adjustable measurement filters: Measured value filters/Filter strength/Foreground suppression/Detection area/Sensitivity and sound beam Display (can be deactivated) Teach-in button(s) (can be deactivated) Reset to factory default

¹⁾ In relation to the current measured value, minimum value ≥ resolution.

²⁾ Referring to current measurement value.

³⁾ Temperature compensation can be switched off, without temperature compensation: 0.17 % / K.

Interfaces

IO-Link	✓, IO-Link V1.1
Function	Process data, diagnosis, parameterization, data storage
Digital output	
Number	1 ¹⁾
Type	Push-pull: PNP/NPN
Maximum output current I_A	≤ 100 mA
Multifunctional input (MF)	1 x MF
Hysteresis	50 mm

¹⁾ Push-pull: PNP/NPN HIGH = $U_V - (< 3 V)$ / LOW < 3 V.

Ambient data

Ambient temperature, operation	-25 °C ... +70 °C
Ambient temperature, storage	-40 °C ... +85 °C

Classifications

ECLASS 5.0	27270804
ECLASS 5.1.4	27270804
ECLASS 6.0	27270804
ECLASS 6.2	27270804
ECLASS 7.0	27270804
ECLASS 8.0	27270804
ECLASS 8.1	27270804
ECLASS 9.0	27270804

ECLASS 10.0	27270804
ECLASS 11.0	27270804
ECLASS 12.0	27272806
ETIM 5.0	EC001846
ETIM 6.0	EC001846
ETIM 7.0	EC001846
ETIM 8.0	EC001846
UNSPSC 16.0901	41111960

Dimensional drawing (Dimensions in mm (inch))

UM30-214

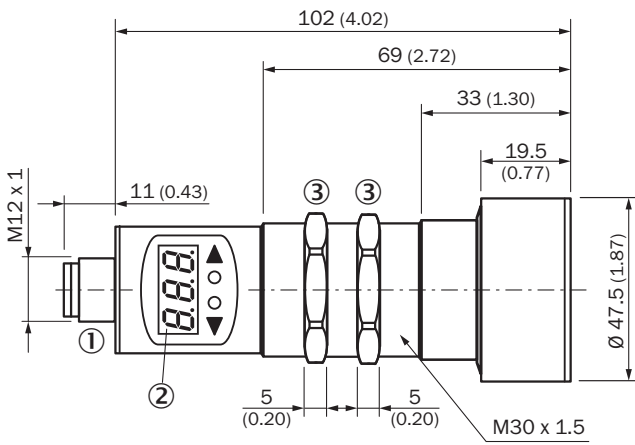

- ① Connection
- ② Display
- ③ Mounting nuts, SW 36 mm

Connection type

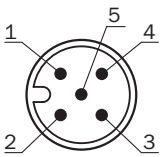

Connection diagram

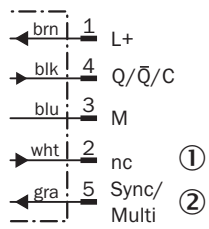

- ① Not assigned
- ② Synchronization and multiplex mode, Connect+ communication

Adjustment possible

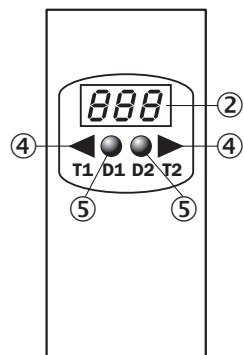

- ② Display
- ④ Control elements
- ⑤ Status indicators

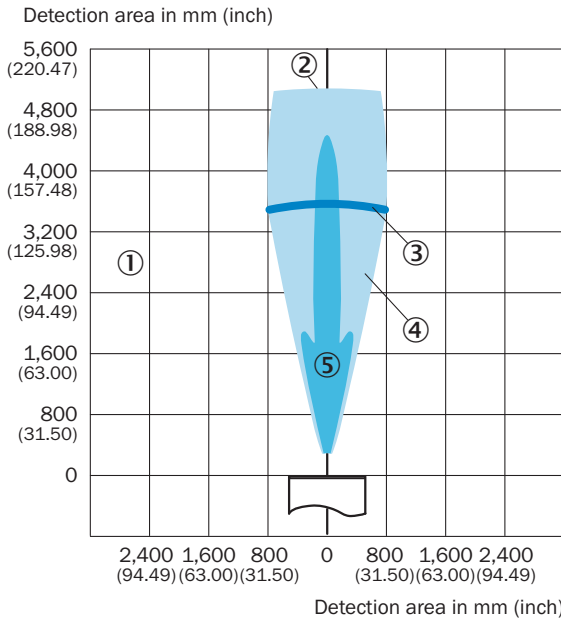

Detection area



- ① Detection range dependent on reflection properties, size, and alignment of the object
- ② Limiting range
- ③ Operating range
- ④ Example object: aligned plate 500 mm x 500 mm
- ⑤ Example object: pipe with 27 mm diameter

Recommended accessories

Other models and accessories → www.sick.com/UM30

	Brief description	Type	Part no.
Connection modules			
	IO-Link V1.1 Class A port, USB2.0 port, optional external power supply 24V / 1A	IOLA2US-01101 (SiLink2 Master)	1061790
Mounting brackets and plates			
	Mounting bracket for M30 sensors, steel, zinc coated, without mounting hardware	BEF-WN-M30	5308445
	<ul style="list-style-type: none"> • Connection type head A: Female connector, M12, 5-pin, straight, A-coded • Connection type head B: Flying leads • Signal type: Sensor/actuator cable • Cable: 2 m, 5-wire, PVC • Description: Sensor/actuator cable, unshielded • Application: Zones with chemicals 	YF2A15-020VB5XLEAX	2096239

SICK AT A GLANCE

SICK is one of the leading manufacturers of intelligent sensors and sensor solutions for industrial applications. A unique range of products and services creates the perfect basis for controlling processes securely and efficiently, protecting individuals from accidents and preventing damage to the environment.

We have extensive experience in a wide range of industries and understand their processes and requirements. With intelligent sensors, we can deliver exactly what our customers need. In application centers in Europe, Asia and North America, system solutions are tested and optimized in accordance with customer specifications. All this makes us a reliable supplier and development partner.

Comprehensive services complete our offering: SICK LifeTime Services provide support throughout the machine life cycle and ensure safety and productivity.

For us, that is “Sensor Intelligence.”

WORLDWIDE PRESENCE:

Contacts and other locations –www.sick.com