

Auslieferungszustand: unmontiert
delivery condition: unmounted

These dimensions will be especially checked at delivery
 Only inspection dimensions
 With /E marked dimensions are only valid for internal use

Diese Maße werden bei Abnahme besonders geprüft
 Ausschließlich Prüfmaße
 Mit /E gekennzeichnete Maße sind nur für interne Zwecke gültig

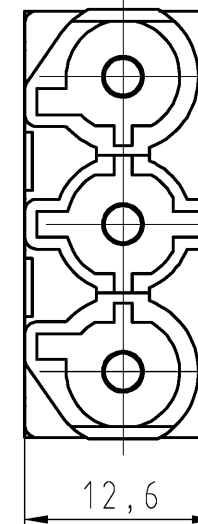
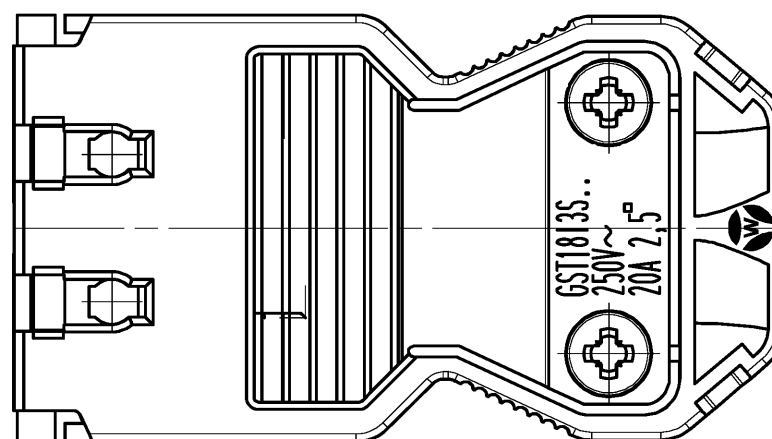
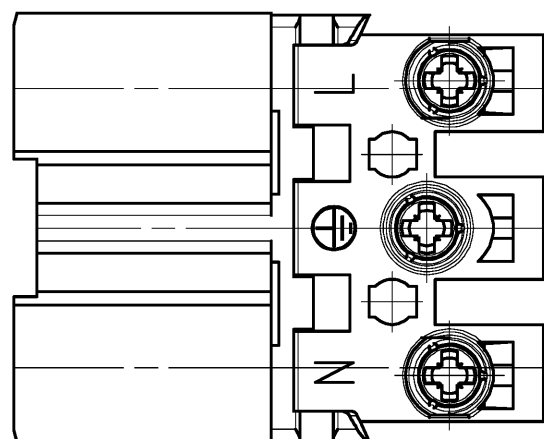
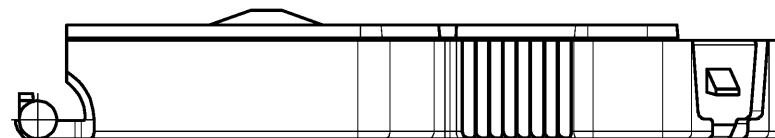
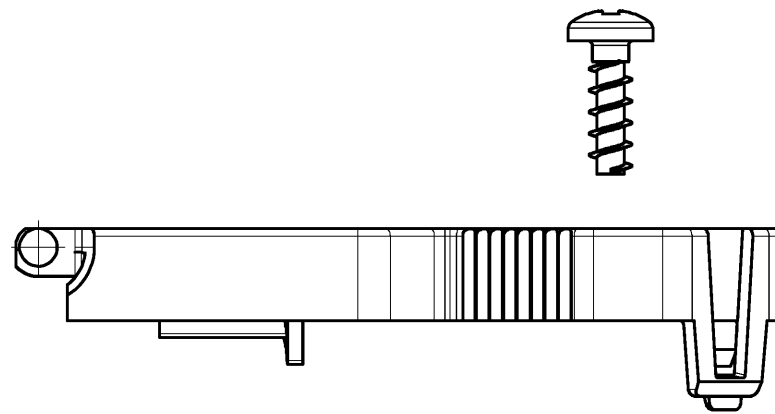
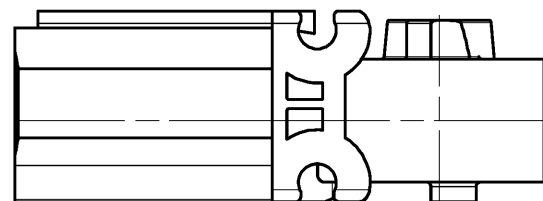

Ansicht im montierten Zustand

drawn in assembled condition

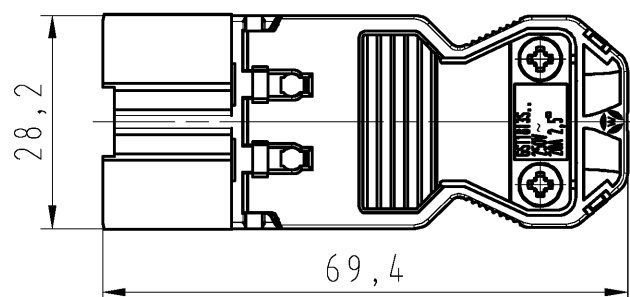

M/scale 1:1

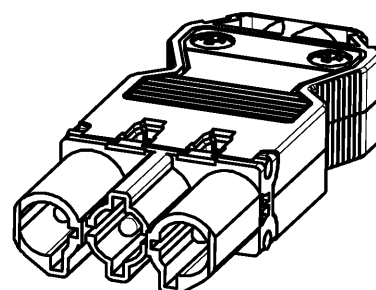

Type:
GST1813S S1 ZR1 RT03

Anwendung: Netzspannung
Application: main voltage

Tolerierung Size ISO 14405(®)/Tolerance system Size ISO 14405(®). (This ISO-standard describes the envelope principle. According to the envelope principle the deviations of form and parallelism are limited by the size tolerances).				ja/yes <input checked="" type="checkbox"/> Stoffverbots- und Deklarationsliste nach UU-TQM-05/03 ist einzuhalten. Conformity with Wieland document UU-TQM-05/03 (list of prohibited / declarable hazardous substances) to be declared!			
Freitoleranz nach General tolerance		CAD - Zeichnung, keine manuellen Änderungen CAD - drawing, no manual modifications allowed		1.Verwendung: First Use: -		Blatt: 1 von 1 Sheet: of 1	
/		Werkstoff/Material Farbe: rot colour: red		2015 Tag/Date Name		Zeichnung Nr./Drawing No.	
/		Maßstab/Scale 2:1		gezeichnet drawn 15.01. Ritter		92.932.3653.0 01K	
/		Vol. mm ³ Of l./Surf. mm ²		geprüft checked -		Index	
/		Vol. mm ³ Of l./Surf. mm ²		Normgepr. Stand. check -		Maße in mm/Dimensions are in mm	
/		wieland		Ersatz für/Replacement for: -		Type	
/		Elektrische Verbindungen		Benennung/Title		MALE CONNECTOR WITH STRAIN RELIEF STECKERT MIT ZUGENTLASTUNG	
Index Datum / Blatt Date / Sheet		Änderung/Revision		mit Schraubanschluß / with screw connection 250V AC 20A 2,5qmm			

Weitergabe sowie Vervielfältigung dieses Dokuments, Verwertung und Mitteilung seines Inhalts sind verboten, soweit nicht ausdrücklich gestattet.
 The reproduction, distribution and utilization of this document as well as the communication of its contents to others without express authorization is prohibited.