

Chemin de câbles fil  
(Mesh tray)

Rail STRUT 41x21  
(STRUT 41x21)

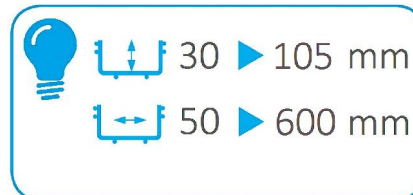
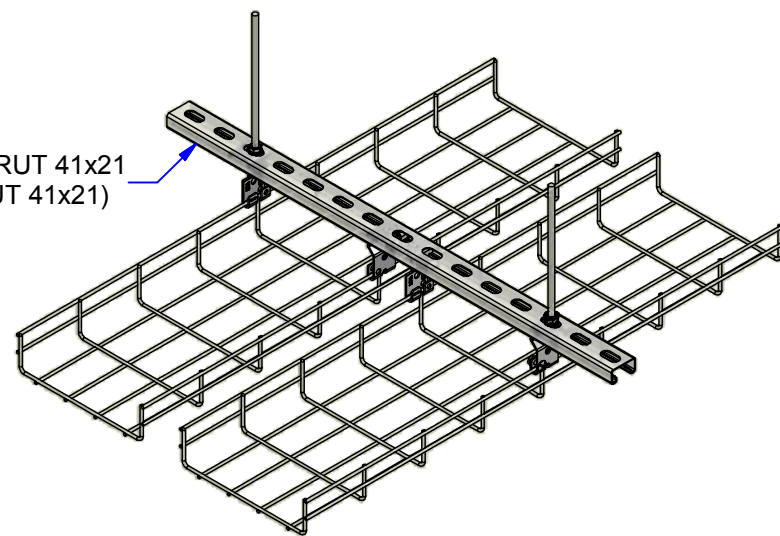

www.niedaxfrance.fr

Description	Code	Masse/Weight Kg/p	Ep./Th. mm	daN
UFA I3	555033	0,070	2,00	100

**SS316L** : Stainless steel according to NF EN 10088-2 (316L).

**I3** : Tôle d'acier inoxydable suivant NF EN 10088-2 (316L).

ATTACHE BALANCELLE UFA I3  
UFA HANGING BRACKET SS316L



ASSISTANCE TECHNIQUE  
+33 (0)1 55 95 92 17  
pole.technique@niedax.fr

FT02406

**NIEDAX**  
France

