



# LMS111-10100S09

LMS1xx

2D LIDAR SENSORS

**SICK**  
Sensor Intelligence.



### Ordering information

Type	Part no.
LMS111-10100S09	1068858

Other models and accessories → [www.sick.com/LMS1xx](http://www.sick.com/LMS1xx)



### Detailed technical data

#### Features

<b>Application</b>	Outdoor
<b>Light source</b>	Infrared (905 nm)
<b>Laser class</b>	1 (IEC 60825-1:2014, EN 60825-1:2014)
<b>Aperture angle</b>	Horizontal 270°
<b>Scanning frequency</b>	25 Hz 50 Hz
<b>Angular resolution</b>	0.25° 0.5°
<b>Heating</b>	Yes
<b>Working range</b>	0.5 m ... 20 m
<b>Scanning range</b>	At 10% remission factor 18 m At 90% remission factor 20 m
<b>Amount of evaluated echoes</b>	2
<b>Fog correction</b>	Yes

#### Mechanics/electronics

<b>Connection type</b>	1 x M12 round connector
<b>Supply voltage</b>	10.8 V DC ... 30 V DC
<b>Power consumption</b>	Typ. 8 W, heating typ. 35 W
<b>Housing color</b>	Gray (RAL 7032)
<b>Enclosure rating</b>	IP67 (EN 60529, Section 14.2.7)
<b>Protection class</b>	III (EN 50178 (1997;10))
<b>Weight</b>	1.1 kg
<b>Dimensions (L x W x H)</b>	105 mm x 102 mm x 162 mm
<b>MTBF</b>	> 100 years

## Safety-related parameters

<b>MTTF<sub>D</sub></b>	> 100 years
-------------------------	-------------

## Performance

<b>Response time</b>	≥ 20 ms
<b>Detectable object shape</b>	Almost any
<b>Systematic error</b>	± 30 mm <sup>1)</sup>
<b>Statistical error</b>	12 mm <sup>1)</sup>
<b>Integrated application</b>	Field evaluation with flexible fields Easy teach option
<b>Number of field sets</b>	10 fields
<b>Simultaneous evaluation cases</b>	10

<sup>1)</sup> Typical value; actual value depends on environmental conditions.

## Interfaces

<b>Ethernet</b>	✓, TCP/IP, RS-232
Remark	OPC DA
Function	Data interface (read result output) Data interface (read result output), Service interface Extension of outputs
Data transmission rate	10/100 MBit/s 9.6 kBaud ... 115.2 kBaud
<b>Digital inputs</b>	2 digital and 2 encoder inputs
<b>Digital outputs</b>	3
<b>Optical indicators</b>	7-segment display (plus 5 LEDs showing device status, contamination warning and initial condition)

## Ambient data

<b>Object remission</b>	2 % ... > 1,000 % (reflectors)
<b>Electromagnetic compatibility (EMC)</b>	EN 61000-6-2:2005 / EN 61000-6-3:2007+A1:2011
<b>Vibration resistance</b>	EN 60068-2-6 (1995-04)
<b>Shock resistance</b>	EN 60068-2-27 (1993-03)
<b>Ambient operating temperature</b>	-30 °C ... +50 °C
<b>Storage temperature</b>	-30 °C ... +70 °C
<b>Ambient light immunity</b>	40,000 lx

## General notes

<b>Note on use</b>	The sensor does not constitute a safety component as defined by relevant legislation on machine safety.
--------------------	---

## Classifications

<b>ECLASS 5.0</b>	27270990
<b>ECLASS 5.1.4</b>	27270990
<b>ECLASS 6.0</b>	27270913
<b>ECLASS 6.2</b>	27270913
<b>ECLASS 7.0</b>	27270913
<b>ECLASS 8.0</b>	27270913
<b>ECLASS 8.1</b>	27270913

<b>ECLASS 9.0</b>	27270913
<b>ECLASS 10.0</b>	27270913
<b>ECLASS 11.0</b>	27270913
<b>ECLASS 12.0</b>	27270913
<b>ETIM 5.0</b>	EC002550
<b>ETIM 6.0</b>	EC002550
<b>ETIM 7.0</b>	EC002550
<b>ETIM 8.0</b>	EC002550
<b>UNSPSC 16.0901</b>	41111615

### Dimensional drawing (Dimensions in mm (inch))

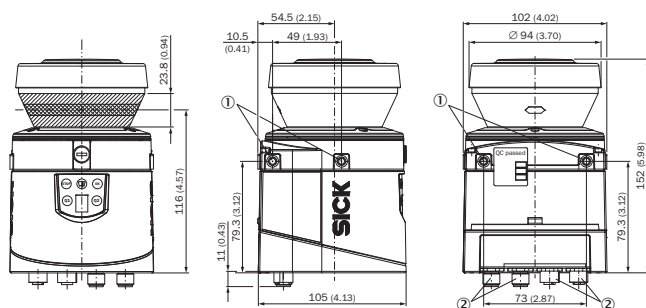

- ① Mounting hole M5 x 7.5
- ② Connector M12

### Working range diagram

Scanning range in m (ft)

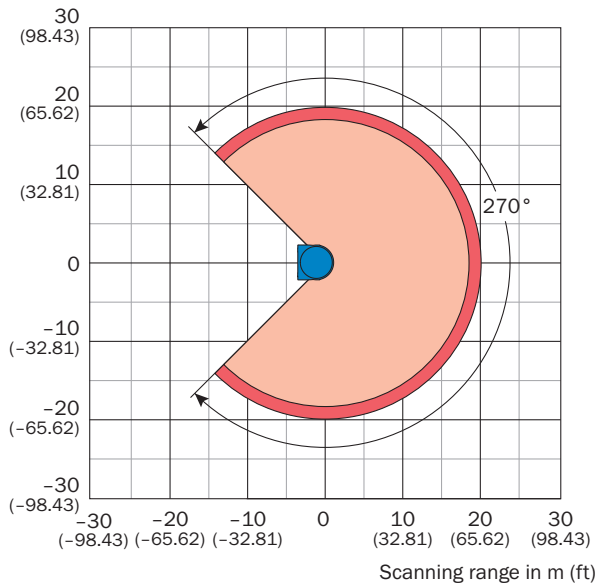

- Scanning range max. 20 m (65.62 ft)
- Scanning range for objects up to 10 % remission 18 m (59.06 ft)

## PIN assignment

“data” connection

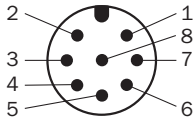

M12 male connector, 8-pin, A-coded

- ① RxD (HOST)
- ② TxD (HOST)
- ③ CAN<sub>H</sub>
- ④ CAN<sub>L</sub>
- ⑤ GND RS/CAN
- ⑥ In<sub>1</sub>
- ⑦ In<sub>2</sub>
- ⑧ GND IN1/2

I/O connection

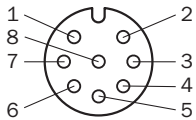

Female connector M12, 8-pin, A-coded

- ① LMS11x: INC1 A / LMS15x/LMS16x: INC1 A or IN4 (switchable, pins 1 and 2 must be switched together)
- ② LMS11x: INC1 B / LMS15x/LMS16x: INC1 B or IN3 (switchable, pins 1 and 2 must be switched together)
- ③ GND INC1
- ④ OUT1 A
- ⑤ GND INC1
- ⑥ OUT3 A
- ⑦ OUT1 ... 3 B
- ⑧ OUT1 ... 3 R

Power

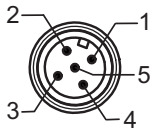

Connector M12, 5-pin, A-coded

- ① V<sub>s</sub>
- ② V<sub>s</sub> Heat.
- ③ GND
- ④ Reserved
- ⑤ GND heat.

Service interface

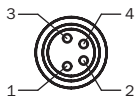



Female connector M8, 4-pin

- ① Reserved
- ② RxD AUX
- ③ GND RS
- ④ TxD AUX

### Recommended accessories

Other models and accessories → [www.sick.com/LMS1xx](http://www.sick.com/LMS1xx)

	Brief description	Type	Part no.
Device protection (mechanical)			
	Weather hood, 190°	Weather protection cover 190°	2046459
	Weather protection hood 270°	Weather protection cover 270°	2046458
①	If the sensor is mounted upside down, the label on top of the weather protection hood must be removed.		
Mounting brackets and plates			
	Standard mounting set for weather hood	Mounting bracket	2046025
	1 piece, mounting bracket for rear mounting on wall or machine	Mounting kit 1a	2034324
	1 piece, mounting bracket for rear mounting on wall or machine with protection of optics hood	Mounting kit 1b	2034325
	1 piece, mounting bracket, adjustable lateral axis, only in conjunction with mounting kit 1a (2034324) or 1b (2034325)	Mounting kit 2	2039302
	1 piece, mounting plate, adjustable longitudinal axis, only in conjunction with mounting kit 2 (2039302)	Mounting kit 3	2039303
Plug connectors and cables			
	<ul style="list-style-type: none"> <li>• <b>Connection type head A:</b> Male connector, M12, 4-pin, straight, D-coded</li> <li>• <b>Connection type head B:</b> Male connector, RJ45, 4-pin, straight</li> <li>• <b>Signal type:</b> Ethernet, PROFINET</li> <li>• <b>Cable:</b> 5 m, 4-wire, PUR, halogen-free</li> <li>• <b>Description:</b> Ethernet, PROFINET, shielded</li> <li>• <b>Application:</b> Drag chain operation, Zones with oils and lubricants</li> </ul>	YM2D24-050PN1MRJA4	2106184
Terminal and alignment brackets			
	Quick-action lock system for weather hood	Quick release	2046989
Others			
	<ul style="list-style-type: none"> <li>• <b>Connection type head A:</b> Female connector, M12, 5-pin, straight, A-coded</li> <li>• <b>Connection type head B:</b> Flying leads</li> <li>• <b>Signal type:</b> Power</li> <li>• <b>Cable:</b> 5 m, 4-wire, PUR, halogen-free</li> <li>• <b>Description:</b> Power, shielded</li> <li>• <b>Connection systems:</b> Flying leads</li> </ul>	YF2A64-050XXXLEAX	6036159

	Brief description	Type	Part no.
	<ul style="list-style-type: none"> <li>• <b>Connection type head A:</b> Male connector, M12, 8-pin, straight, A-coded</li> <li>• <b>Connection type head B:</b> Flying leads</li> <li>• <b>Signal type:</b> Sensor/actuator cable</li> <li>• <b>Cable:</b> 5 m, 8-wire, PUR, halogen-free</li> <li>• <b>Description:</b> Sensor/actuator cable, shielded</li> <li>• <b>Connection systems:</b> Flying leads</li> <li>• <b>Application:</b> Zones with oils and lubricants, Drag chain operation</li> </ul>	YM2A28-050UA6XLEAX	6036155
	<ul style="list-style-type: none"> <li>• <b>Connection type head A:</b> Female connector, M12, 8-pin, straight, A-coded</li> <li>• <b>Connection type head B:</b> Flying leads</li> <li>• <b>Signal type:</b> Sensor/actuator cable</li> <li>• <b>Cable:</b> 5 m, 8-wire, PUR, halogen-free</li> <li>• <b>Description:</b> Sensor/actuator cable, shielded</li> <li>• <b>Application:</b> Zones with oils and lubricants, Drag chain operation</li> </ul>	YF2A28-050UA6XLEAX	2095835

## Recommended services

Additional services → [www.sick.com/LMS1xx](http://www.sick.com/LMS1xx)

	Type	Part no.
Maintenance		
<ul style="list-style-type: none"> <li>• <b>Product area:</b> 2D LiDAR sensors, 3D LiDAR sensors</li> <li>• <b>Range of services:</b> Inspection, analysis and restoring of defined functions, Inspection and adaptation of basic settings, parameters of field application, filters for raw data output, and product-specific configuration</li> <li>• <b>Duration:</b> Additional work will be invoiced separately</li> <li>• <b>Travel expenses:</b> The prices do not include travel costs such as hotel, flight, travel time and expenses.</li> </ul>	Maintenance of LiDAR sensors	1682593
Commissioning		
<ul style="list-style-type: none"> <li>• <b>Product area:</b> 2D LiDAR sensors, 3D LiDAR sensors</li> <li>• <b>Range of services:</b> Inspection of connection, fine adjustment, configuration of monitored areas, configuration and optimization of parameters as well as tests, Setup of previously defined functions of basic settings, parameters of field application, filters for raw data output and product-specific configuration</li> <li>• <b>Travel expenses:</b> The prices do not include travel costs such as hotel, flight, travel time and expenses.</li> <li>• <b>Duration:</b> Additional work will be invoiced separately</li> </ul>	Commissioning LiDAR sensors	1680672
Extended warranty		
<ul style="list-style-type: none"> <li>• <b>Product area:</b> Identification solutions, machine vision, Detection and ranging solutions, safety camera sensors, Safety laser scanners, Safety radar sensors</li> <li>• <b>Range of services:</b> The services correspond to the scope of the statutory manufacturer warranty (SICK general terms of delivery).</li> <li>• <b>Duration:</b> Five-year warranty from delivery date.</li> </ul>	Extended warranty for a total of five years from delivery date	1680671

## SICK AT A GLANCE

SICK is one of the leading manufacturers of intelligent sensors and sensor solutions for industrial applications. A unique range of products and services creates the perfect basis for controlling processes securely and efficiently, protecting individuals from accidents and preventing damage to the environment.

We have extensive experience in a wide range of industries and understand their processes and requirements. With intelligent sensors, we can deliver exactly what our customers need. In application centers in Europe, Asia and North America, system solutions are tested and optimized in accordance with customer specifications. All this makes us a reliable supplier and development partner.

Comprehensive services complete our offering: SICK LifeTime Services provide support throughout the machine life cycle and ensure safety and productivity.

For us, that is “Sensor Intelligence.”

## WORLDWIDE PRESENCE:

Contacts and other locations –[www.sick.com](http://www.sick.com)