



CSM-WP117A2P

CSM

COLOR SENSORS

SICK
Sensor Intelligence.



Illustration may differ

Ordering information

Type	Part no.
CSM-WP117A2P	1067294

Other models and accessories → www.sick.com/CSM



Detailed technical data

Features

Dimensions (W x H x D)	12 mm x 31.5 mm x 21 mm
Sensing distance	≤ 12.5 mm
Sensing distance tolerance	± 3 mm
Housing design	Small
Light source	LED, RGB ¹⁾
Wave length	640 nm, 525 nm, 470 nm
Light spot size	1.5 mm x 6.5 mm
Light spot direction	Vertical
Adjustment	Teach-in button, cable, IO-Link
Teach-in mode	Static 1-point teach-in

¹⁾ Average service life: 100,000 h at T_J = +25 °C.

Mechanics/electronics

Supply voltage	12 V DC ... 24 V DC ¹⁾
Ripple	< 5 V _{pp} ²⁾
Current consumption	< 50 mA ³⁾
Switching frequency	1.7 kHz ⁴⁾

¹⁾ Limit values: DC 12 V (-10 %) ... DC 24 V (+20 %). Operation in short-circuit protected network max. 8 A.

²⁾ May not exceed or fall below U_v tolerances.

³⁾ Without load.

⁴⁾ With light/dark ratio 1:1.

⁵⁾ Signal transit time with resistive load.

⁶⁾ At supply voltage > 24 V, I_{max} = 50 mA. I_{max} is consumption count of all Q_N.

Response time	300 μ s ⁵⁾
Jitter	150 μ s
Switching output	PNP
Switching output (voltage)	PNP: HIGH = $U_V \leq 2$ V / LOW approx. 0 V
Switching mode	Light/dark switching
Output (channel)	8 colors via IO-Link
Output current I_{max}	< 100 mA ⁶⁾
Connection type	Cable with M12 male connector, 4-pin, 0.2 m
Cable diameter	\varnothing 3.4 mm
Protection class	III
Circuit protection	U_V connections, reverse polarity protected Output Q short-circuit protected Interference pulse suppression
Enclosure rating	IP67
Weight	Approx. 25 g
Housing material	Plastic, ABS
Optics material	Plastic, PMMA

1) Limit values: DC 12 V (-10 %) ... DC 24 V (+20 %). Operation in short-circuit protected network max. 8 A.

2) May not exceed or fall below U_V tolerances.

3) Without load.

4) With light/dark ratio 1:1.

5) Signal transit time with resistive load.

6) At supply voltage > 24 V, $I_{max} = 50$ mA. I_{max} is consumption count of all Q_n .

Communication interface

IO-Link	✓, V1.1
Data transmission rate	38,4 kbit/s (COM2)
Cycle time	2.3 ms
VendorID	26
DeviceID HEX	800071
DeviceID DEC	8388721
Process data length	16 Bit
Process data structure A	Bit 0 = switching signal Q_{L1} Bit 1 = switching signal Q_{L2} Bit 2 = Quality of Run Alarm Bit 3 ... 5 = Emission Color Bit 6 ... 15 = Measurement Value RGB
Process data structure B	Bit 0 = switching signal Q_{L1} Bit 1 = switching signal Q_{L2} Bit 2 = switching signal Q_{L3} Bit 3 = switching signal Q_{L4} Bit 4 = switching signal Q_{L5} Bit 5 = switching signal Q_{L6} Bit 6 = switching signal Q_{L7} Bit 7 = switching signal Q_{L8} Bit 9 ... 15 = empty
Digital output	Q_1, Q_2
Number	2

Ambient data

Ambient operating temperature	-10 °C ... +55 °C
Ambient temperature, storage	-20 °C ... +75 °C
Shock load	According to IEC 60068
UL File No.	NRKH.E348498 & NRKH7.E348498

Classifications

ECLASS 5.0	27270907
ECLASS 5.1.4	27270907
ECLASS 6.0	27270907
ECLASS 6.2	27270907
ECLASS 7.0	27270907
ECLASS 8.0	27270907
ECLASS 8.1	27270907
ECLASS 9.0	27270907
ECLASS 10.0	27270907
ECLASS 11.0	27270907
ECLASS 12.0	27270907
ETIM 5.0	EC001817
ETIM 6.0	EC001817
ETIM 7.0	EC001817
ETIM 8.0	EC001817
UNSPSC 16.0901	39121528

Connection type/pinouts

Connection type	Cable with M12 male connector, 4-pin, 0.2 m
Connection type Detail	
Cable diameter	Ø 3.4 mm
Conductor cross section	0.15 mm ²
Cable material	PVC
Pinouts	
BN 1	+ (L+)
WH 2	Q
BU 3	- (M)
BK 4	Q/C

Dimensional drawing (Dimensions in mm (inch))

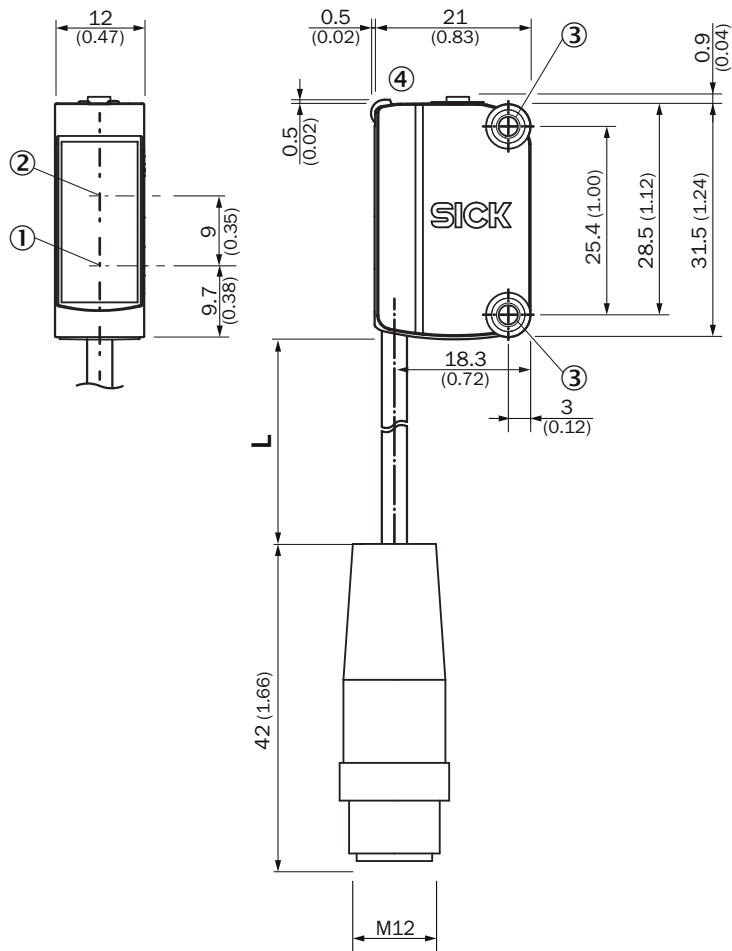

For length of cable (L), see technical data

- ① Center of optical axis, sender
- ② Center of optical axis, receiver
- ③ Mounting holes M3
- ④ Display and adjustment elements

Pinouts

Pinouts, see Technical details: **Connection type/pinouts**

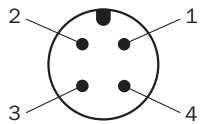

M12 male connector, 4-pin, A-coding

Adjustments

Display and adjustment elements

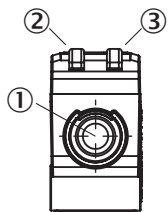

- ① Teach-in button
- ② LED yellow
- ③ LED green

Concept of operation

Setting the switching threshold

1. Trigger teach-in

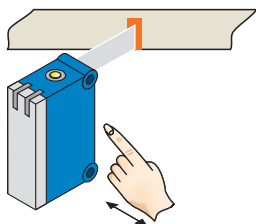

Position object in light field.
Press teach-in button > 1 s.

2. Select color tolerance

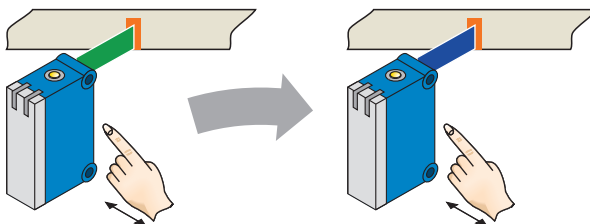

Press teach-in button when
transmitted light is green
= **tolerance medium**
(standard setting).

Press teach-in button when
transmitted light is blue
= **tolerance precise.**

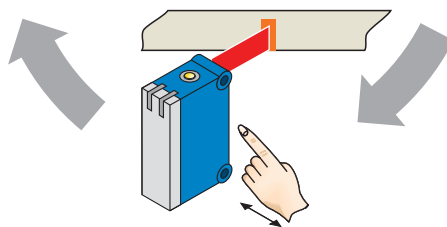

Press teach-in button when
transmitted light is red
= **tolerance coarse.**

Teach-in can also be performed using an external control signal (only dynamic teach-in).



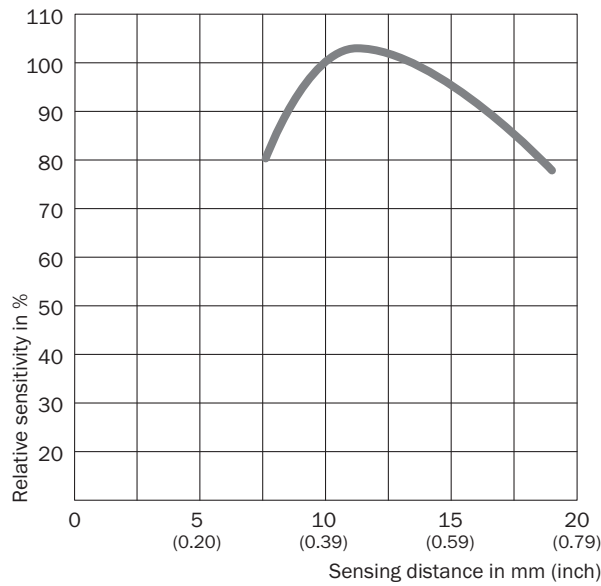

Keylock activation and deactivation: hold down teach-in button > 30 s.



Sensing distance



Recommended accessories

Other models and accessories → www.sick.com/CSM

	Brief description	Type	Part no.
Cloning modules			
	IO-Link version V1.1, Port class 2, PIN 2, 4, 5 galvanically connected, Supply voltage 18 V DC ... 32 V DC (limit values, operation in short-circuit protected network max. 8 A)	IOLP2ZZ-M3201 (SICK Memory Stick)	1064290
	IO-Link V1.1 Class A port, USB2.0 port, optional external power supply 24V / 1A	IOLA2US-01101 (SiLink2 Master)	1061790
Mounting brackets and plates			
	Stainless steel (1.4301)	BEF-WN-G6	2062909
Plug connectors and cables			
	<ul style="list-style-type: none"> Connection type head A: Male connector, M12, 4-pin, straight Description: Unshielded Connection systems: Screw-type terminals Permitted cross-section: ≤ 0.75 mm² 	STE-1204-G	6009932
	<ul style="list-style-type: none"> Connection type head A: Female connector, M12, 4-pin, straight, A-coded Connection type head B: Flying leads Signal type: Sensor/actuator cable Cable: 5 m, 4-wire, PVC Description: Sensor/actuator cable, unshielded Application: Zones with chemicals 	YF2A14-050VB3XLEAX	2096235

	Brief description	Type	Part no.
Sensor Integration Gateway			
	<ul style="list-style-type: none"> Further functions: Web server integrated, USB connection for easy configuration of the SIG200 Sensor Integration Gateway with SOPAS ET, the engineering tool from SICK, logic editor is available for easy configuration of logic functions Connection CONFIG: 1 x M8, 4-pin female connector, USB 2.0 (USB-A) Logic editor: yes Communication interface: IO-Link, USB, Ethernet, PROFINET, REST API Product category: IO-Link Master 	SIG200-0A0412200	1089794
	<ul style="list-style-type: none"> Further functions: Web server integrated, USB connection for easy configuration of the SIG200 Sensor Integration Gateway with SOPAS ET, the engineering tool from SICK, logic editor is available for easy configuration of logic functions Connection CONFIG: 1 x M8, 4-pin female connector, USB 2.0 (USB-A) Logic editor: yes Communication interface: IO-Link, USB, Ethernet, REST API Product category: IO-Link Master 	SIG200-0A0G12200	1102605

Recommended services

Additional services → www.sick.com/CSM

	Type	Part no.
Function Block Factory		
<ul style="list-style-type: none"> Description: The Function Block Factory supports common programmable logic controllers (PLCs) from various manufacturers, such as Siemens, Beckhoff, Rockwell Automation and B&R. More information on the FBF can be found <a _blank"="" href="https://fbf.cloud.sick.com target=">here. Note: You can configure your function block at <a _blank"="" href="https://fbf.cloud.sick.com target=">Function Block Factory. As a login please use your SICK ID. 	Function Block Factory	On request

SICK AT A GLANCE

SICK is one of the leading manufacturers of intelligent sensors and sensor solutions for industrial applications. A unique range of products and services creates the perfect basis for controlling processes securely and efficiently, protecting individuals from accidents and preventing damage to the environment.

We have extensive experience in a wide range of industries and understand their processes and requirements. With intelligent sensors, we can deliver exactly what our customers need. In application centers in Europe, Asia and North America, system solutions are tested and optimized in accordance with customer specifications. All this makes us a reliable supplier and development partner.

Comprehensive services complete our offering: SICK LifeTime Services provide support throughout the machine life cycle and ensure safety and productivity.

For us, that is “Sensor Intelligence.”

WORLDWIDE PRESENCE:

Contacts and other locations –www.sick.com