

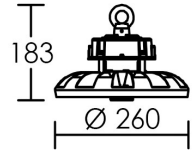













	<h1>SAPPHIRE 100W</h1>		<b>Code / Réf</b>	
			 90°	<b>51330</b>
			 60°	<b>51341</b>

220 - 240V 50 / 60 Hz	100W	4000k	 2.35		IP65	IK08	1-10V 0-10V						
--------------------------	------	-------	--	---	------	------	----------------	---	---	---	---	---	---

FR	 Ne jetez pas vos déchets électriques avec les déchets ménagers. Confiez votre appareil à votre centre de recyclage pour son traitement approprié.	 Suivez la fiche d'instructions pour garantir un fonctionnement fiable et sécurisé. À conserver pour consultation ultérieure. Les produits doivent être installés par un électricien qualifié conformément aux normes internationales de câblage.
EN	Waste electrical products must not be disposed of with household waste. This tool should be taken to your recycling center for safe treatment.	Follow Instruction Sheet to ensure safe and reliable operation. Retain for future reference. Products should be installed by a qualified Electrician in accordance with International Wiring Regulations.
DE	Dieses Gerät darf nicht mit dem Hausmüll/Restmüll entsorgt werden. Das Altgerät nur in einer öffentlichen Sammelstelle abgeben.	Die Gebrauchsanweisung befolgen, damit der sichere und zuverlässige Betrieb gewährleistet ist. Zum späteren Nachschlagen aufheben. Die Produkte müssen von einem qualifizierten Elektriker in Übereinstimmung mit den relevanten Vorschriften installiert werden.
IT	I rifiuti elettrici non devono essere smaltiti con i rifiuti domestici. Questo strumento deve essere portato al centro di riciclaggio per un trattamento sicuro.	Seguire il foglio delle istruzioni per garantire il funzionamento sicuro e affidabile. Conservare per riferimento futuro. I prodotti devono essere installati da un elettricista qualificato conformemente alle normative internazionali sui cablaggi.
ES	Los productos eléctricos de desecho no deben ser eliminados con residuos domésticos. Esta herramienta debe ser llevada a su centro de reciclaje para un tratamiento seguro.	Siga la hoja de instrucciones para garantizar la seguridad y un funcionamiento fiable. Consérvela para utilizarla como material de referencia en el futuro. Los productos los debe instalar un técnico electricista cualificado en virtud de las normativas internacionales en materia de cableado.
FR	Le câble ou le cordon extérieur souple de ce luminaire ne peut pas être remplacé ; si le câble est endommagé, le luminaire doit être détruit.	
EN	The external flexible cable or cord of this luminaire cannot be replaced; if the cord is damaged, the luminaire shall be destroyed.	
DE	Das äußere flexible Kabel oder Kabel dieser Leuchte kann nicht ersetzt werden; wenn das Kabel beschädigt ist, muss die Leuchte zerstört werden.	
IT	Il cavo o il cavo flessibile esterno di questo apparecchio di illuminazione non possono essere sostituiti; se il cavo è danneggiato, l'apparecchio di illuminazione deve essere distrutto.	
ES	El cable o cable flexible externo de esta luminaria no podrá sustituirse; si el cable está dañado, la luminaria se destruirá.	
FR	 La source lumineuse contenue dans ce luminaire ne doit être remplacée que par un employé de Aric, un agent ou une personne qualifiée.	
EN	The light source contained in this luminaire must only be replaced by an Aric employee, an agent or a qualified person.	
DE	Die Lichtquelle in dieser Leuchte darf nur durch einen Aric-Angestellten, einen Agenten oder eine qualifizierte Person ersetzt werden.	
IT	La sorgente luminosa contenuta in questo apparecchio deve essere sostituita soltanto da un dipendente di Aric, da un agente o da una persona qualificata.	
ES	La fuente luminosa contenida en esta luminaria sólo será sustituida por un empleado de Aric, un agente o una persona cualificada..	
FR	Ce produit contient une source lumineuse de classe d'efficacité énergétique	 
EN	This product contains a light source of energy efficiency class	
DE	Dieses Produkt enthält eine Lichtquelle der Energieeffizienzklasse	
IT	Questo prodotto contiene una sorgente luminosa di classe di efficienza energetica	
ES	Este producto contiene una fuente luminosa de la clase de eficiencia energética	

**1-**

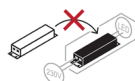

M4  
2Nm

**2-**

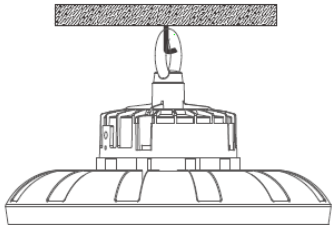

**3-**

HO5RN-F3xG1<sup>2</sup>

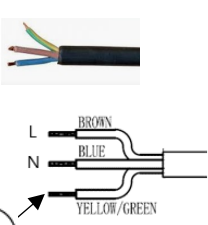

L BROWN  
N BLUE  
YELLOW/GREEN

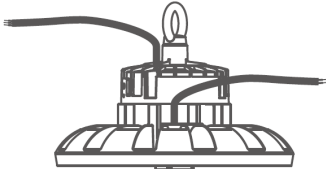

10 V  
0 - 1V

220-240 V 50/60Hz



Option / Optional/ opção / opzione / opción

- Ref: 51334
- Ref :51335

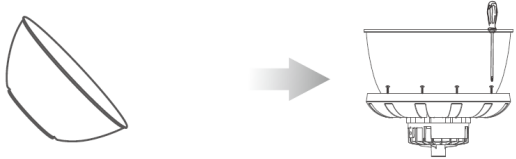

M3  
1Nm