



Product designation				Power contactor
Product type designation				BF09
Contact characteristics				
Number of poles	Nr.			4
Rated insulation voltage U _i IEC/EN	V			690
Rated impulse withstand voltage U _{imp}	kV			6
Operational frequency	min	Hz		25
	max	Hz		400
IEC Conventional free air thermal current I _{th}	A			25
Operational current I _e	AC-1 (≤40°C)	A		25
	AC-1 (≤55°C)	A		20
	AC-1 (≤70°C)	A		18
	AC-3 (≤440V ≤55°C)	A		9
	AC-4 (400V)	A		4.9
Rated operational power AC-1 (T≤40°C)	230V	kW		9.5
	400V	kW		16
	500V	kW		21
	690V	kW		27
Short-time allowable current for 10s (IEC/EN60947-1)	A			150
Protection fuse	gG (IEC)	A		25
	aM (IEC)	A		10
Making capacity (RMS value)	A			90
Breaking capacity at voltage	440V	A		72
	500V	A		72
	690V	A		71
Resistance per pole (average value)	mΩ			2.5
Power dissipation per pole (average value)	I _{th}	W		1.6
	AC-3	W		0.2
Tightening torque for terminals	min	Nm		1.5
	max	Nm		1.8
	min	lbin		1.1
	max	lbin		1.5
Tightening torque for coil terminal	min	Nm		0.8
	max	Nm		1
	min	lbin		0.8
	max	lbin		0.74
Max number of wires simultaneously connectable	Nr.			2

Conductor section			
AWG/Kcmil		max	10
Flexible w/o lug conductor section			
		min	mm ² 1
		max	mm ² 6
Flexible c/w lug conductor section			
		min	mm ² 1
		max	mm ² 4
Flexible with insulated spade lug conductor section			
		min	mm ² 1
		max	mm ² 4
Power terminal protection according to IEC/EN 60529			IP20 when properly wired
Mechanical features			
Operating position			
		normal allowable	Vertical plan ±30°
Fixing			Screw / DIN rail 35mm
Weight			g 368
Conductor section			
AWG/kcmil conductor section		max	10
Operations			
Mechanical life		cycles	20000000
Electrical life		cycles	2000000
Safety related data			
Performance level B10d according to EN/ISO 13489-1			
		rated load	cycles 2000000
		mechanical load	cycles 20000000
Mirror contacts according to IEC/EN 60947-4-1			YES
EMC compatibility			yes
AC coil operating			
Rated AC voltage at 50/60Hz		V	400
AC operating voltage			
of 50/60Hz coil powered at 50Hz			
pick-up			
		min	%Us 80
		max	%Us 110
drop-out			
		min	%Us 20
		max	%Us 55
of 50/60Hz coil powered at 60Hz			
pick-up			
		min	%Us 85
		max	%Us 110
drop-out			
		min	%Us 20
		max	%Us 55
AC average coil consumption at 20°C			
of 50/60Hz coil powered at 50Hz			
		in-rush	VA 75
		holding	VA 9

of 50/60Hz coil powered at 60Hz

in-rush	VA	70
holding	VA	6.5

of 60Hz coil powered at 60Hz

in-rush	VA	75
holding	VA	9

Dissipation at holding $\leq 20^{\circ}\text{C}$ 50Hz

W	2.5
---	-----

Max cycles frequency

Mechanical operation

cycles/h	3600
----------	------

Operating times

Average time for Us control

in AC

Closing NO

min	ms	8
max	ms	24

Opening NO

min	ms	10
max	ms	20

Closing NC

min	ms	14
max	ms	28

Opening NC

min	ms	7
max	ms	18

UL technical data

Full-load current (FLA) for three-phase AC motor

at 480V	A	7.6
at 600V	A	9

Yielded mechanical performance

for single-phase AC motor

110/120V	HP	0.8
230V	HP	2

for three-phase AC motor

200/208V	HP	3
220/230V	HP	3
460/480V	HP	5
575/600V	HP	7.5

General USE

Contactors

AC current	A	25
------------	---	----

Ambient conditions

Temperature

Operating temperature

min	$^{\circ}\text{C}$	-50
max	$^{\circ}\text{C}$	70

Storage temperature

min	$^{\circ}\text{C}$	-60
max	$^{\circ}\text{C}$	80

Max altitude

m	3000
---	------

Resistance & Protection

Pollution degree

3

Dimensions

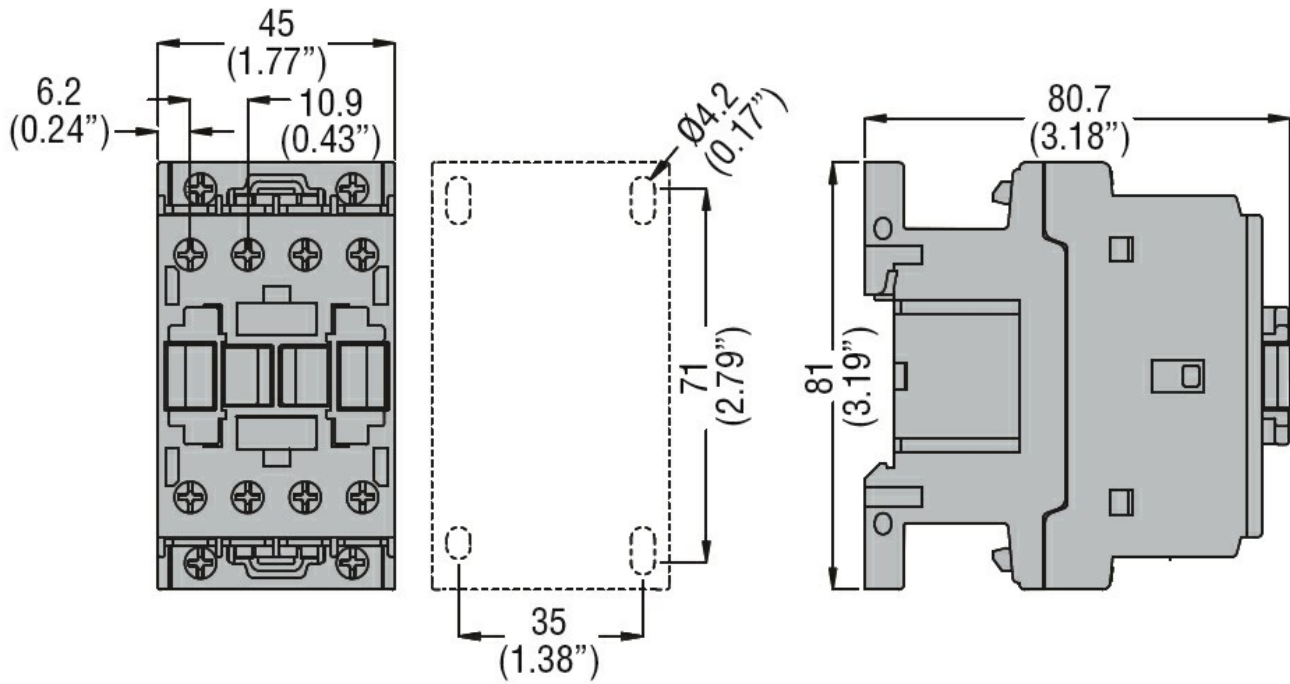

Wiring diagrams

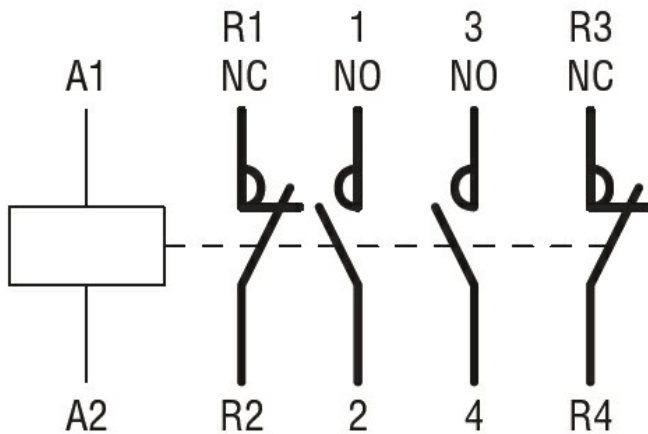

Certifications and compliance

Compliance

CSA C22.2 n° 60947-1
CSA C22.2 n° 60947-4-1
IEC/EN/BS 60947-1
IEC/EN/BS 60947-4-1
UL 60947-1
UL 60947-4-1

Certificates

CCC
cULus
EAC

ETIM classification

ETIM 8.0

EC000066 -
Power contactor,
AC switching